



Government Gazette

OF

WESTERN AUSTRALIA

(Published by Authority at 3.30 p.m.)

No. 12]

PERTH: WEDNESDAY, 6 FEBRUARY

[1985

HEALTH ACT 1911.

BACTERIOLYTIC TREATMENT OF SEWAGE AND DISPOSAL OF EFFLUENT AND LIQUID WASTE REGULATIONS.

Published in the *Government Gazette* on 3 September 1974 and now reprinted pursuant to the Reprinting of Regulations Act 1954, incorporating the amendments thereto published in the *Government Gazette* on—

(erratum) 13 September 1974;
21 April 1978;
18 December 1981; and
29 June 1984.

1

Reprinted pursuant to the Reprinting of Regulations Act 1954 by authority of the Attorney General dated 29 January 1985.

HEALTH ACT 1911.

BACTERIOLYTIC TREATMENT OF SEWAGE AND DISPOSAL OF EFFLUENT AND LIQUID WASTE REGULATIONS.

DIVISION 1.—PRELIMINARY.

1. (1) These regulations may be cited as the Bacteriolytic Treatment of Sewage and Disposal of Effluent and Liquid Waste Regulations.

(2) These regulations have effect in every district within the State.

2. These regulations are divided as follows—

- 1.—Preliminary.
- 2.—Applications and Installations.
- 3.—Construction and Sizes of Septic Tanks.
- 4.—Restricted Flush Fixtures.
- 5.—Dry-type Tanks and Bore Holes.
- 6.—Disposal of Contents of Septic Tanks and other Receptacles for Drainage.
- 7.—Disposal of Effluent and Liquid Wastes.
- 8.—Manufacturers.
Schedules.

3. In these regulations—

“apparatus” has the same meaning as is given by section 3 of the Act to the term “apparatus for the bacteriolytic treatment of sewage”;

“approved” means approved by the Executive Director, Public Health;

“combined system” means an apparatus designed to receive household and such other liquid wastes as the Executive Director, Public Health may approve, as well as sewage;

“effluent” means the liquid discharge from the bacteriolytic treatment tank;

“fixtures” means all necessary appurtenances, that may be attached to the plumbing or drainage system of premises and are intended for the collection or retention of any wastes or waste waters for ultimate discharge into a drain or sewer;

“fittings” means all pipes, meters, or other apparatus used for or in connection with the supply of water, and all pipes, cisterns, traps, syphons, manholes, ventilators and all other apparatus connected with and requisite to secure the safe and proper working of any sewer, drain or water supply fixtures;

“liquid wastes” means bathroom, kitchen, scullery and laundry wastes, stable washings and any other domestic or trade wastes, other than effluent, that are permitted to be discharged by means of a drain to a receptacle for drainage;

“receptacle for drainage” means an evaporation drain, a soak well, french drain, leach drain or impervious sump;

“separate system” means an apparatus designed to receive faecal matter and urine only;

“septic tank” means that part of an apparatus for the bacteriolytic treatment of sewage designed to retain sewage for bacteriolytic treatment;

“the Act” means the Health Act 1911.

Amended by
G.G. 29/6/84,
p. 1781.

DIVISION 2.—APPLICATION AND INSTALLATION.

Amended by
G.G. 29/6/84,
p. 1781.

4. (1) The owner, or person authorized to act on behalf of the owner, of any premises whereon it is intended to construct an apparatus shall apply to the Executive Director, Public Health on the prescribed form for permission to construct the apparatus, and shall pay the prescribed fee.

(2) Where an apparatus is to be installed in conjunction with the erection of a new building, a block plan showing the position of the septic tank and all relevant drainage, shall be submitted to the local authority with the building plan.

Amended by
G.G. 29/6/84,
p. 1781.

5. (1) An application pursuant to regulation 4 of these regulations shall be in the form of Schedule "A" to these regulations and shall be accompanied by—

(a) a copy of plan and specifications of the proposed apparatus showing plan and longitudinal section to a scale of not less than 1:50;

(b) two copies of a block plan of the premises accurately drawn to a scale not less than 1:100, showing—

(i) the position of all buildings erected or proposed and the position of the proposed apparatus;

(ii) the position and dimensions of the closet, the position of the door and pedestal, and details of ventilation;

(iii) the position of all drains, pipes, inspection openings, vents, traps and junctions in relation to buildings and boundaries;

(iv) the size of pipes and fittings and the fall of the drains;

(v) details of the effluent disposal system; and

(vi) the source of water supply to be used in connection with the apparatus,

and except where the plans refer to a building of Class I or Class IA occupancy under the Uniform Building By-laws the plans shall be separate from the application form; and

(c) if so requested by the Executive Director, Public Health, a detailed architectural drawing of the proposed apparatus.

(2) No alteration or deviation from the approved plans shall be made until an amended plan has been lodged with the local authority.

(3) Any person who gives any false or misleading information in, or in relation to, an application under this Division commits an offence.

6. A person who applies for permission to construct a combined system shall, in addition to complying with the requirements of regulation 5 of these regulations, show on the block plan the position, type and proposed use of all fixtures intended to discharge into the apparatus, and shall also show particulars of all drains, pipes, inspection openings, vents, traps and junctions to be used in connection with the apparatus.

Amended by
G.G. 29/6/84,
p. 1781.

7. (1) All materials, fixtures and fittings to be used in the construction of an apparatus shall be first approved by the Executive Director, Public Health but for the purposes of this regulation, a material, fixture or fitting which has been branded in accordance with the by-laws made under the Metropolitan Water Supply, Sewerage, and Drainage Act 1909, or the Country Towns Sewerage Act 1948, shall be deemed to have been so approved by the Executive Director, Public Health if the material, fixture or fitting bears a mark indicating that it has been inspected by a person authorized under one of those Acts or these regulations, and passed as fit for use.

(2) All materials, pipes, bends, junctions, traps, vents and apparatus shall be sound and free from defects and shall be installed in accordance with the by-laws and practices of the Metropolitan Water Supply, Sewerage and Drainage Board, or the Country Towns Sewerage By-laws, as the case requires and these regulations.

8. (1) All educt vents in connection with septic tanks and receptacles for drainage, whether on combined systems, separate systems or liquid wastes only, shall be fitted, by the owner, with an approved mosquito-proof cowl and be so maintained by him.

(2) Where a back vent is required but cannot be connected to the educt vent by means of a saddle piece, the back vent shall also be fitted with an approved mosquito-proof cowl to be so maintained.

3

Inspection and Approval to Use an Apparatus.

9. A person who constructs an apparatus, pursuant to a permit issued by the Executive Director, Public Health, whether as owner or contractor to the owner or otherwise, shall forthwith, after the construction of the apparatus is completed, notify the local authority of the fact. Amended by
G.G. 29/6/84,
p. 1781.

10. (1) A local authority which has received a notification in accordance with regulation 9 of these regulations shall as soon as reasonably practicable thereafter arrange for the apparatus to be inspected with regard to its compliance with the plans and specifications relating to the permit under which the construction was undertaken, and the standard of materials and workmanship.

(2) If the apparatus complies with the requirements of these regulations, the local authority shall grant approval for the use of the apparatus, and issue a certificate in the form of Schedule "B" to these regulations.

11. A person who gives notice to the local authority in accordance with regulation 9 of these regulations shall prepare the apparatus for inspection at the time set by the local authority or its officer, and in particular shall—

- (a) fill the treatment tank to overflow level with clean water 24 hours prior to inspection; and
- (b) ensure that all lines of drain, fixtures and fittings are exposed to view, and all inspection openings are unsealed.

Tests.

12. The apparatus shall be submitted to hydrostatic and mirror tests, and such other tests as a health surveyor may order.

13. The equipment, material, power and labour necessary for the inspection and tests shall be furnished by the person installing the apparatus.

14. Any materials, pipes, bends, junctions, fittings, fixtures and apparatus found to be defective shall be removed and replaced and all defective joints made tight and every part of the work shall be made to conform to these regulations and shall be again subject to the approval of the Executive Director, Public Health or health surveyor. Amended by
G.G. 29/6/84,
p. 1781.

Prohibiting Entry of Certain Matter into Tank.

15. The occupier of any premises whereon there is an apparatus, shall not cause or permit any wastes from any business or industry to discharge into the apparatus except with the approval of the Executive Director, Public Health. Amended by
G.G. 29/6/84,
p. 1781.

16. The Executive Director, Public Health may forbid the discharge into a septic tank of any matter which may interfere with the efficient bacterial operation of the septic tank. Amended by
G.G. 29/6/84,
p. 1781.

17. No person shall turn into, or cause or suffer to enter, any apparatus or receptacle for drainage used for the reception of effluent or liquid wastes—

- (a) any surface or subsoil drainage, rain water from any pavement or roof, or overflow water from rainwater tanks or flushing systems, or other relatively clean water;
- (b) any inflammable or explosive materials that are not readily soluble in water, or any materials which when mixed with sewage or water are liable to form explosive compounds or to interfere with the treatment process.
- (c) any insoluble matter or articles, dead animals, or rubbish whatsoever; or
- (d) any liquids or solids that are bactericidal in effect in such quantity as to militate against the proper functioning of the septic tank.

Interfering with Tanks.

18. No person shall, without first obtaining permission in writing from the local authority, dismantle or remove wholly or in any part any apparatus, or alter or change the mode of operating the apparatus.

4

Damaged and Defective Tanks Not to be Used.

19. (1) A person shall not use a septic tank that becomes damaged or defective.

(2) The owner of any premises shall not permit or suffer any person to use on such premises any septic tank which is damaged or defective.

Prohibition.

Amended by
G.G. 29/6/84,
p. 1781.

20. A permit shall not be issued for the installation of a septic tank for any property which can be connected to an existing sewerage system, unless the Executive Director, Public Health is satisfied that in all the circumstances it would be unreasonable to refuse the issue of the permit.

21. (1) No septic tank shall be constructed closer than 1.22 m to the foundations of any house or other building, or the boundary of any lot, unless otherwise approved by the local authority.

(2) No foundations of any house or other building or additions thereto shall be permitted closer than 1.22 m to any existing septic tank, unless otherwise approved by the local authority.

(3) A person shall not cause any structure to be erected above any septic tank, receptacle for drainage or drainage line if that structure—

(a) obstructs free access to the septic tank, receptacle for drainage or drainage line; or

(b) has walls on more than three sides.

22. A gully trap shall not be used in an installation for the bacteriolytic treatment of sewage.

Fees.

Amended by
G.G. 18/12/81,
p. 5192;
G.G. 29/6/84,
p. 1781.

23. (1) The fee to be paid to the Executive Director, Public Health by an applicant for a permit to construct an apparatus is \$10.

(2) Where the local authority carries out the inspection of the installation of the apparatus, the Executive Director, Public Health shall pay to the local authority one-half of the fee received under this regulation.

(3) Where a local authority undertakes a general scheme for the installation of septic tanks in accordance with Part IV of the Act, the local authority shall pay to the Executive Director, Public Health one-half of the fees prescribed in this regulation and in such a case the provisions of subregulation (2) of this regulation do not apply, but if the number of installations in the scheme is 100 or more, the fees to be paid by the local authority to the Executive Director, Public Health shall be one-quarter of the fees prescribed by subregulation (1) of this regulation and in such a case the provisions of subregulation (2) of this regulation do not apply.

DIVISION 3.—CONSTRUCTION AND SIZES OF SEPTIC TANKS.

Amended by
G.G. 29/6/84,
p. 1781.

24. Every septic tank shall have a minimum water level of 1 065 mm except where otherwise approved by the Executive Director, Public Health.

25. (1) When the capacity of a septic tank exceeds 2 045 litres the tank shall be divided into two chambers by means of a fixed durable partition, and the partition shall be located so that the capacity of the first chamber is twice that of the second chamber.

(2) Suitable openings with a full unobstructed area of not less than 0.015 m² shall be provided in the partition at approximately half the liquid depth in the tank and so placed as to ensure the maximum length of flow through the tank.

26. Every septic tank shall be so constructed as to be impervious.

27. Every septic tank shall be constructed of good quality bricks set in 3 in 1 cement mortar, and covered internally with a 12 mm thick watertight cement render, or spun or vibrated, reinforced concrete, or other approved material.

5

28. Every domestic septic tank shall have a liquid capacity in litres calculated as follows— Amended by
G.G. 29/6/84,
p. 1781.

(a) tanks serving or to serve water closets and urinals only—

No. of persons using	Liquid capacity—litres
1-10	1 820 minimum

and where the number of persons is greater than 10 and not more than 100 the liquid capacity of the tank in litres shall not be less than 1 360, plus 45 litres per person;

(b) tanks treating or to treat all household wastes—

No. of persons using	Liquid capacity—litres
1-10	3 180 minimum

and where the number of persons is greater than 10 and not more than 100, the liquid capacity of the tank in litres shall not be less than 1 820, plus 135 litres per person;

(c) a septic tank to serve more than 100 people shall be of the dimensions, design and construction as the Executive Director, Public Health determines.

29. (1) The sizes for septic tanks, other than domestic tanks, shall be calculated on a basis of 1 360 litres for a separate system and 1 820 litres for a combined system plus the number of litres per person shown in the following table— Amended by
G.G. 29/6/84,
p. 1781.

Type of Premises.	Separate System litres	Combined System. litres
Hotel	90	180
Motel	70	140
School (Boarding)	70	140
School (Day)	30	45
Public Building (Frequent use)	15	30
Public Building (Infrequent use)	5	10
Caravan Park	90	140
Swimming Pool	10	15
Drive-In Theatres (2 persons per car)	10	10
Factories and shops (based on the number of person therein on any 8 hour shift)	45	70
Construction Camps (Temporary)	25	45
Clubs	10	15
Clubs (Licensed)	25	35

(2) The sizes of septic tanks to be used in hospitals, nursing homes and similar establishments, shall be as required by the Health Department, provided that no separate system shall be of less than 1 820 litres capacity and no combined system shall be of less than 3 180 litres capacity.

30. A septic tank shall have a minimum air space between water level and under side of cover of 380 mm vertically.

31. Rectangular septic tanks shall be so constructed that the internal effective length shall be not less than twice the internal effective width, and the partition so placed that the first compartment is twice the capacity of the second compartment.

Precast Concrete Tanks.

32. All precast concrete septic tanks shall conform to the following requirements— Amended by
G.G. 29/6/84,
p. 1781.

(a) Concrete shall contain not less than 354 kg of cement per cubic metre, with a maximum water/cement ratio of 22 litres of water to every 40 kg of cement, and shall be mixed from materials complying with Code No. C.A. 2 or A.77 or in accordance with 1379-1973 of the Standards Association of Australia, and shall have a compressive strength of not less than 20 MPa at 28 days.

(b) All concrete produced in precasting yards, and intended for the construction of any apparatus for the bacteriolytic treatment of sewage, shall be weigh batched.

- (c) (i) Total compaction shall be secured by high ratio spinning, suitable to the diameter of the section chosen, or, in the case of vertically and horizontally cast tanks, shall be by the use of foam, immersion or table vibrators operating at not less than 75 Hz per second.
- (ii) Immersion vibrators shall be inserted into the concrete at intervals of not more than 460 mm and the concrete shall be placed in continuous shallow layers not exceeding 300 mm in depth.
- (iii) The vibrators shall be inserted vertically and shall not be used to flow the concrete.
- (iv) Where form vibrators are used, the forms shall be capable of withstanding the vibration without loss of watertightness.
- (v) Vibration at a rate of not less than 75 Hz per second shall continue for not less than one minute in the case of form and table vibrators.
- (vi) Where immersion vibrators are used, each insertion of a poker vibrator shall be of not less than 20 seconds duration.
- (vii) The diameter of any immersion vibrators shall not exceed one-third of the thickness of the concrete section.
- (d) (i) Form work shall be coated with a suitable release agent which will not retard the surface of the concrete.
- (ii) Forms shall be gently prised from the concrete surfaces.
- (iii) Any surface exhibiting honey-combing, voids, flow lines, or cold joints shall be rejected.
- (e) Precast concrete septic tanks may be one of two types—
- (i) series type as shown on application form, the internal diameter of the first tank to be 1 520 mm and of the second to be 1 220 mm; or
- (ii) horizontal cylindrical tanks as shown on application form, the length to be 2 400 mm and the internal diameter to be of 1 520 mm with a water level of 1 065 mm.
- (f) (i) The walls of cylindrical septic tanks shall be reinforced with steel mesh complying with A.S. 1304-1973, and with the requirements of the following table—
- | Internal Pipe Diameter | Reinforcement Mesh No. |
|------------------------|------------------------|
| 1 220 mm | F.—41 |
| 1 520 mm | F.—41 |
- or, by a helically wound grid of hard drawn steel wire providing an equivalent strength of circumferential steel per unit length of cylinder.
- (ii) All joints in the steel fabric shall be made by tying a full two mesh over-lap. Spun tanks shall have a minimum of 12 mm cover and vibrated tanks shall have a minimum of 20 mm cover.
- (g) The minimum wall thickness shall not be less than one-twenty-fourth of the maximum internal diameter.
- (h) Each septic tank shall—
- (i) have maximum absorption of 10 per cent; and
- (ii) be able to withstand a load of at least 6 600 N on the barrel of the pipe, at 14 days.
- (i) The ends of concrete cylindrical horizontal tanks shall be in one piece, not less than 65 mm thick, and shall be reinforced with F.41 steel mesh and shall be keyed and mortared to the body of the tank and shall be watertight.
- (j) The bottom in vertically installed tanks shall be poured using concrete complying with paragraph (a) of this regulation and shall be 100 mm thick and extending 75 mm beyond the walls in all directions and shall be reinforced, as and where required by the local authority.
- (k) A separate bottom may be provided for each tank in a series type installation if the tanks are spaced not less than 1 000 mm or more than 1 800 mm apart and the pipe connecting the tanks complies with regulation 7 of these regulations or is P.V.C. piping not less than 100 mm in diameter complying with A.S.K. 138-1969 class P.C.

7

- (l) The covers of vertical tanks shall be of concrete, not less than 65 mm thick and shall be reinforced with F.41 steel mesh, made in sections and the joins shall be rebated.
- (m) Heavy duty covers that are to be subjected to wheeled traffic shall be to individual specifications, approved by the Executive Director, Public Health.
- (n) Concrete test specimens of covers shall provide a flexural strength of 2 MPa at 28 days and shall be designed to carry a uniformly distributed load of 7 kPa.
- (o) Partitions where required, shall be constructed of concrete complying with paragraph (a) and shall be 50 mm thick, reinforced with F.41 steel mesh and all joints of mesh to have a full two mesh overlap and not less than 12 mm concrete cover.
- (p) Appropriate inspection openings, 150 mm in diameter, shall be provided in the cover above the vertical leg of the inlet and outlet fittings of the septic tank.
- (q) The covers to inspection openings shall be of cast iron or other material approved by the Executive Director, Public Health and when in place after installation, the inspection opening covers shall fit neatly to prevent the ingress of water or egress of mosquitoes.

33. (1) Where a precast concrete septic tank is tested for the purpose of ascertaining whether it complies with these regulations the test shall be carried out in accordance with A.S.A. 35-1957 and A.S. No. 1012, 1971, Parts 1-13, and precast concrete and concrete masonry segments shall be tested in accordance with A.S.A. 87-1963 concrete blocks.

Amended by
G.G. 29/6/84
p. 1781.

(2) Each pipe or block selected by the health surveyor for testing shall be so marked by the manufacturer, that it may be identified at any time with the consignment or batch it represents.

(3) Tests shall be carried out, either—

(a) in an approved laboratory; or

(b) on the premises of a manufacturer where testing equipment is provided.

(4) Where tests are carried out on the premises of a manufacturer, those tests shall be carried out in the presence of a health surveyor or an inspector appointed under the Act, who shall select the items to be tested by random sampling.

(5) A manufacturer shall not allow testing equipment on his premises to be used unless it has been inspected and a certificate of efficiency relating to that equipment has been issued by an approved laboratory within the previous twelve months.

(6) One tank in every fifty with the same nominal diameter shall be subjected to a load test.

(7) Where a tank develops a clearly visible crack while undergoing a load test it shall be rejected.

(8) Where a tank, after being tested is rejected, the entire batch of fifty shall be rejected, but where the manufacturer so desires, each of the remaining forty-nine tanks may be tested separately and individual tanks which pass the test may be accepted.

(9) Every tank which is accepted shall be branded, the brand shall be the word "TESTED" and the initials of the local authority or Health Department (either of whom may apply the brand) in letters at least 20 mm high, and shall be placed on the inner side of the tank not more than 305 mm from the top.

(10) A certificate from an approved laboratory, identifying an item shall be accepted as proof that the item has been tested, and the local authority or Officer of the Department may brand a tank accordingly.

(11) The samples for segment testing shall be blocks which are representative of the batch from which they are selected, the blocks being chosen at random by an authorized inspecting officer, and where a block fails the test the whole batch shall be rejected but where a batch complies with the specifications a certificate to that effect shall be issued by the inspecting officer, a copy of which shall be forwarded to the Department.

8

(12) All costs and fees in relation to the testing of tanks and segments shall be borne by the manufacturer.

(13) The fee for testing each tank shall be \$5.00.

Cast in Situ Concrete Tanks.

34. (1) All concrete work in connection with the construction of *in situ* concrete septic tanks, shall be carried out in strict accordance with A.S. C.A. 2-1973, employing concrete mixes complying with paragraph (a) of regulation 32 of these regulations.

(2) All concrete shall be poured in continuous shallow layers not exceeding 300 mm in depth.

(3) An immersion vibrator, operating at not less than 75 Hz per second, shall be inserted vertically at not more than 460 mm intervals.

(4) All form work shall be watertight, and coated with a suitable release agent which will not retard the surface of the concrete.

(5) Dimensions and reinforcements shall be in accordance with the plans and specifications set out in Schedule "B" to these regulations and shall be inspected immediately prior to the pouring of the concrete.

(6) All steel meshes shall comply with A.S. 1304-1973.

(7) The tank shall be filled with water immediately the forms are removed.

(8) The covers shall consist of a central *in situ* reinforced slab 125 mm thick rebated on each end 50 mm x 40 mm, and each end shall be covered with removable precast slabs 760 mm long by not more than 460 mm x 50 mm thick reinforced with F.41 steel mesh.

(9) Every partition shall be of concrete 50 mm thick reinforced with F.41 steel mesh.

Rectangular Brick Tanks.

35. (1) All brick septic tanks shall be constructed of good quality bricks properly bonded and set in 3 in 1 cement mortar, and rendered internally to a smooth finish with a 2 in 1 cement mortar 12 mm thick.

(2) A reinforced concrete floor, a minimum of 100 mm thick, shall be poured prior to the laying of the bricks, and the floor shall extend 75 mm beyond the brickwork in all directions.

(3) (a) The walls shall be a minimum of 230 mm (1 bk) thick to a maximum depth of 1 300 mm.

(b) From a depth of 1 300 mm to 1 900 mm, the walls shall be a minimum of 350 mm thick (1½ bks).

(c) From a depth of 1 900 mm to a maximum depth of 2 400 mm the walls shall be a minimum of 470 mm thick (2 bks).

(4) No brick tank shall be so constructed as to have a depth of more than 2 400 mm.

(5) Partitions shall be in accordance with the provisions of regulations 25 and 32 or subregulation (1) of this regulation, as the case requires.

(6) Covers shall be so constructed as to comply with the provisions of subregulation (8) of regulation 34 of these regulations.

Substituted by G.G. 21/4/78, pp. 1218-1220. Amended by G.G. 29/6/84, p. 1781.

36. (1) A manufacturer shall not produce fibreglass septic tanks unless the design of each model has been approved by the Executive Director, Public Health and each tank conforms with the following requirements—

(a) the resin shall be isophthalic or bisphenol type resin and shall be chemically resistant, suitable for curing at ambient and advanced temperatures with addition of suitable catalysts and promoters in accordance with the resin manufacturer's recommendations;

(b) the glass reinforcement shall be composed of "E" type glass fibres;

(c) the gel coat shall be unreinforced or reinforced isophthalic or bisphenol resin free from cracks, pinholes and surface defects and shall be a minimum of 0.25 mm and a maximum of 0.4 mm thick and shall

9

include not more than 0.5% by weight of polyester compatible translucent pigment, and where isophthalic resin is used to fabricate the laminate, the gel coat must comprise an isophthalic resin, and similarly with bisphenol resins;

(d) the tank—

- (i) shall have a minimum total wall thickness of 5 mm and shall contain not less than 30% glass, and no fillers or pigments shall be included in the laminate;
- (ii) shall have the exposed side of the laminate (away from the mould) coated with a clear layer of catalysed resin after the laminate has cured;
- (iii) the inlet and outlet holes shall be accurately moulded to neatly accept all attachments which may be secured according to instructions from the manufacturer, or which may be fibreglassed into place and then coated internally with gel in accordance with the provisions of paragraph (c) of this subregulation, and coated externally with resin in accordance with the provisions of subparagraph (ii) of paragraph (d) of this subregulation; and
- (iv) shall not exceed 3 180 litres capacity measured at the operating liquid level for which the tank has been designed;

(e) a tank cover shall be a minimum of 5 mm thick maintaining the 30% glass content ratio and reinforced to withstand a minimum load of 0.5 tonnes and a cover shall—

- (i) be supplied with three openings;
- (ii) provide 150 mm diameter inspection openings over inlet and outlet squares; and
- (iii) provide a minimum 510 mm diameter opening in the centre of the lid for cleaning purposes;

(f) the gel coat for a tank cover may contain an opaque polyester compatible pigment in accordance with the manufacturer's recommendations;

(g) all cured laminate used in the manufacture of fibreglass tanks shall have the following properties—

Specific Gravity	1.5 min.
Flexural Strength	10 x 10 ⁴ kPa min.
Flexural Modulus	8 x 10 ⁹ kPa min.
Impact Strength	533 Joules/Metre
Hardness (Barcol) Ref, ASF3-1962	50 min. (after 48 hours)
Moisture pick up	0.5% max. 24 hours
Glass content	30% min.
Thickness	4 mm for body per min. 5 mm for lid per min.
Specific Tolerance on length	Plus or minus 12.7 mm
Diameter including out of round	Plus or minus 6.5 mm
Entrapped air Max. No. of Bubbles	15 per 1 000 mm ²
Max. Size	1.6 mm thick;

(h) where the manufacturer uses the "lay up by hand" or the "lay up by spray application" method of applying fibreglass to septic tanks, he shall have available the following plant and equipment—

- (i) a mould for the tank which may be fixed or capable of being rotated mechanically at a speed that can be adjusted by the operator;
- (ii) equipment for measuring the thickness and degree of hardness of the walls of the completed tank at any point;
- (iii) platform scales capable of weighing the completed tank and smaller scales for weighing the glass rovings;

(i) one of the following means of antibuoyancy anchorage shall be provided within the tank—

- (i) a fibreglass flange around the outer wall of the tank at least 100 mm wide placed midway between the bottom and top of the tank; or

10

(ii) a galvanised iron pipe across the underside of the tank, held in place by nylon cord loops bonded to the base of the tank, the pipe being embedded into the earth at the side of the hole;

(j) the following details shall be permanently affixed or incorporated within the resin in a prominent position—

- (i) inlet and outlet positions;
- (ii) the manufacturer's name or trade mark both on the body and cover;
- (iii) a serial number on both the tank and the lid placed beside or under the name of the trade mark.

(2) The manufacturer shall make available a sample from each moulding, identifiable with the original moulding, and the specimen shall be at least 0.15 m² in size and be identified by the appropriate serial number.

(3) The sample referred to in subregulation (2) of this regulation, shall be retained for a period of not less than two years.

(4) A health surveyor or inspector appointed under the Act may inspect any fibreglass septic tank, conducting such tests, including the drilling of holes in the body of a tank, as he considers necessary to ascertain if it complies with these regulations, and where the fibreglass tank is accepted, it shall be branded in accordance with subregulation (9) of regulation 33 of these regulations.

(5) All costs and fees, including the cost of any repairs, in relation to the testing of a fibreglass tank shall be borne by the manufacturer.

(6) The fee for testing each tank shall be \$5.00.

DIVISION 4.—RESTRICTED FLUSH FIXTURES.

Amended by
G.G. 29/6/84,
p. 1781.

37. (1) Notwithstanding the provisions of any other Division of these regulations, where—

- (a) the area or nature of land available will not permit the satisfactory disposal of effluent from a standard 9 litre flush; or
- (b) there is not sufficient water available to operate a standard 9 litre flush at all times,

but a water supply of not less than 13.5 kl is available, the Executive Director, Public Health may approve the use of alternative fixture and fitting comprising a cistern, flush pipe and water closet pan, (herein referred to as "intermediate flush fixtures and fittings") of a design approved by the Executive Director, Public Health, in which event the variations from the Metropolitan Water Supply, Sewerage and Drainage By-laws and these regulations set out in this regulation may be made.

(2) The Executive Director, Public Health shall not approve a type of any intermediate flush fixtures and fittings unless—

- (a) each pan is constructed of suitable non-absorbent materials and is of good workmanship and free from defects;
- (b) each pan, when flushed, is completely washed over the interior surface;
- (c) the water seal retained in each pan after each flushing is not less than 25 mm;
- (d) each pan is branded with the volume of the flush by means of which it is designed to operate; and
- (e) the volume of flush by means of which the pan is designed to operate is not more than 5 litres, or less than 3.5 litres.

(3) No type of flushing cistern for use in any intermediate flush fixtures and fittings shall be approved by the Executive Director, Public Health unless—

- (a) at each operation of each cistern the volume of water flushed is not more than 5 litres, or less than 3.5 litres;
- (b) each cistern is so constructed that when filled to operating capacity an air gap is left between the surface of the water and the outlet of the ball cock;

11

- (c) the volume of the water flushed by each operation of each cistern is painted or otherwise displayed by a durable medium on the exterior of the cistern;
- (d) the flush pipe has an internal diameter of not less than 40 mm, expanded to 45 mm at the point of connection to the closet pan;
- (e) the length of drain between the closet pan and the septic tank serving the closet pan, or between the closet pan and any junction with a drain leading from any other fixture in regular or daily use is not longer than 3 m; and
- (f) the vent horn on the water closet pan shall be deleted except where required under the by-laws of the Metropolitan Water Supply, Sewerage and Drainage Board.

Minimum Flush Fixtures and Fittings for Use with Septic Tanks.

38. (1) Notwithstanding the provisions of any other Division of these regulations and regulation 37 of these regulations where—

Amended by
G.G. 29/6/84
p. 1781.

- (a) inspections and tests have been made, and it is not possible to dispose of the effluent from a septic tank used with a water closet pan by any of the methods set out in regulation 37 of these regulations; or
- (b) where there is insufficient water to operate a flush of 3.5 litres or more at all times,

the Executive Director, Public Health may, provided that he is satisfied that satisfactory means of disposal of effluent can thereby be made available and that no nuisance will be created, approve the use of an alternative fixture and fitting comprising a cistern flushing arrangement and pan (herein referred to as "minimum flush fixtures and fittings") of a design approved by the Executive Director, Public Health, in which event the modifications set out in regulations 38 and 39 may be made.

(2) The Executive Director, Public Health shall not approve a type of minimum flush fixtures and fittings unless—

- (a) the pan complies with the provisions of regulation 37 except that the trap may be omitted and replaced by a mechanically operated sealing device;
- (b) the seal is maintained by water or by a sealing device held in close contact with the pan outlet and the seal is maintained at all times except when the fitting is in use;
- (c) the design of the sealing device is such that force is required to open it and that it shall return to the closed position automatically after the pan is flushed;
- (d) the mechanism of the sealing device is readily accessible, reliable and not adversely affected by corrosive atmosphere; and
- (e) the pan is capable of being flushed with 1 litre of water and the manufacture of the minimum flush fittings shall brand in an approved manner the flushing capacity thereof and for testing purposes the fittings shall flush with the quantity of water so indicated as the flushing capacity.

(3) Fixtures and fittings approved under this regulation shall be tested in suites and be clearly marked, and shall be so sold.

39. (1) The Executive Director, Public Health shall not approve the use of minimum flush fixtures and fittings on any land unless—

Amended by
G.G. 29/6/84,
p. 1781.

- (a) the pan is mounted within 2.4 m of the septic tank;
- (b) the pan compartment is detached from the house or, if attached to the house, at least two sides are external walls, has no opening to the inside of the house and no opening to the pan compartment is within 915 mm of any opening to the house;
- (c) the dimensions and construction of the compartment shall be in accordance with the by-laws in force under the Act but, in addition, fixed glass louvres of not less than 0.19 m² shall be provided in one of the external walls and any screens or partitions erected for the purpose of securing privacy are so placed as not to interfere with adequate fresh air ventilation of the pan compartment; and
- (d) a water supply of not less than 9 kl is available to the land.

12

(2) Fixtures and fittings approved under this regulation shall not be connected to septic tanks to serve more than ten persons or to tanks treating all household wastes.

(3) Notwithstanding the provisions of Division 3 of these regulations, the liquid capacity of the septic tank in this Division shall be in accordance with the following table—

Number of Persons Using.	Capacity.	Cyl. Dia.
1 to 10	1 820 litres	1 520 mm

and the length of rectangular tanks shall be not less than twice the width and the effluent shall be disposed of within the boundaries of the premises by one of the means approved under Division 7 of these regulations.

(4) Notwithstanding the provisions of subregulation (2) of regulation 38 of these regulations—

- (a) where a water seal is used, the approved depth of the seal shall be maintained after flushing;
- (b) where there is no water seal, the sealing device shall be such that 570 ml of water poured into the pan above the seal will not leak past the seal in less than twenty seconds; and
- (c) the inspecting officer shall from time to time after the installation has been completed repeat the test on the seal and where the seal is defective shall require the owner by notice in writing within a time specified in such notice to repair or adjust the seal, or both, so that the test will be passed.

Amended by
G.G. 29/6/84,
p. 1781.

40. (1) The manufacture of, or agent for fixtures or fittings referred to in this Division, may apply to the Executive Director, Public Health for a certificate of approval of any type of fixture or fitting and each application shall be accompanied by—

- (a) full scale drawings and specifications relating to the type of pan or cistern in question; and
- (b) an application fee calculated at the rate of two dollars for each type of pan or cistern in respect of which the certificate is sought.

(2) The Executive Director, Public Health may require an applicant to furnish him with a specimen or working model of the type of pan or cistern in respect of which the certificate is sought and with such further particulars relating to that type as he considers necessary for the purpose.

(3) Upon receipt of an application the Executive Director, Public Health shall cause to be examined and inspected the drawings and specifications and the specimen or model and the further particulars furnished, if any, and if he approves of the type, he shall cause a certificate of approval in the form of Form No. 2 in Schedule "D" of these regulations to be issued to the applicant.

Amended by
G.G. 29/6/84,
p. 1781.

41. (1) Upon receipt of an application in the form of Form No. 1 in Schedule "D" by a person who wishes to have a closet pan or flushing cistern tested, the Executive Director, Public Health shall cause the pan or cistern to be tested by an inspector who is qualified to test such apparatus.

(2) If the closet pan or flushing cistern is found fit for use, the inspector shall affix a brand thereto consisting of the letters HD↑ which shall be 12 mm in height.

(3) Before a brand is affixed to any closet pan or flushing cistern, the applicant shall upon demand pay to the Executive Director, Public Health a charge for the registration of the application calculated as follows—

	\$
For each closet pan tested	0.20
For each flushing cistern tested	0.20
And for each application	1.00

(4) No person other than an inspector referred to in subregulation (1) of this regulation shall affix a brand of such description as is referred to in that subregulation or any mark resembling that brand to a closet pan or flushing cistern.

42. The variations set out in this Division shall be the only variations permissible in respect of installations of intermediate and restricted flush fixtures and fittings, respectively, for use with septic tanks and the installations shall in all other respects be carried out in complete accordance with the requirements of the Metropolitan Water Supply, Sewerage and Drainage By-laws, the Country Towns Sewerage By-laws and the other Divisions of these regulations.

DIVISION 5.—DRY TYPE SEPTIC TANK.

43. Notwithstanding the provisions of any of the preceding Divisions of these regulations, where, for any reason, it is impractical to install any other type of treatment tanks, the Executive Director, Public Health may approve the installation of a "Dry Type" Septic Tank, which shall comply with the following conditions:—

Amended by
G.G. 29/6/84,
p. 1781.

- (a) the tank shall only be installed with the written approval of the Executive Director, Public Health and in a position approved by a health surveyor;
- (b) the tank shall be constructed as set out in Schedule "E" of these regulations, unless otherwise specified by the Executive Director, Public Health;
- (c) the tank shall not be within 6 m of any house, or 1.8 m of any boundary or 30 m of any well, creek or underground source of water;
- (d) the door of the privy shall be hung so that there is, when the door is closed, a clear space of at least 75 mm above and below it;
- (e) the wall of the privy opposite the door shall have a fixed glazed louvre of not less than 0.1 m² situated 1.8 m above floor level;
- (f) the pedestal pan shall be of an approved type, built into the floor of the closet and shall be provided with a close fitting lid;
- (g) the liquid capacity of the septic tank shall be in accordance with the following table—

Number of Persons Using	Capacity in Litres
1 to 10	1 820 ;

- (h) effluent disposal shall be by one of the means set out in Division 7 of these regulations except that a soak well may be reduced to 915 mm diameter and 1.2 m deep, a french or leach drain to 6 m minimum length, and an evaporation drain to 9 m minimum length; and
- (i) the educt vent shall be fitted with an approved mosquito proof cowl.

Bore-hole Type Privies.

44. (1) Where it is necessary to provide a temporary privy in accordance with the requirements of by-law 1AA of the Model By-laws Series A in force under the Act, such a privy may, subject to the approval of the local authority, be a bore-hole type privy, and for the purposes of this regulation a bore-hole privy shall include the pedestal type pan, the slab into which the pan fits and the enclosure.

Amended by
G.G. 29/6/84,
p. 1781.

(2) Any bore-hole privy installed in accordance with this regulation shall comply with the following conditions—

- (a) it shall be fitted with a closet pan of a type in respect of which the Executive Director, Public Health has issued a certificate of approval in accordance with the provisions of the Act and these regulations;
- (b) it shall be installed only in a position approved by a health surveyor, but in any event shall not be situated closer than 30.5 m to any underground water supply intended or available for human consumption;
- (c) the bore-hole shall be not less than 1.2 m or more than 2.4 m deep and not less than 150 mm or more than 205 mm in diameter;
- (d) the privy shall comply with the requirements of subparagraphs (b), (c) and (d) of paragraph 1 of by-law 1B of the Model By-laws Series A in force under the Act;
- (e) the privy shall be inspected and approved by the health surveyor of the local authority before it is used;
- (f) the privy shall be maintained in a clean, fly-proof, and structurally sound condition and in accordance with the requirements of these regulations; and

14

- (g) prior to its removal from the site or immediately it ceases to be used, the privy shall be thoroughly cleansed and the bore-hole filled with clean earth.

(3) In pursuance of section 110 of the Act, the whole of every local authority district is prescribed as being the area within which provision may be made for the reception of nightsoil below ground by means of a bore-hole type privy.

Chemical Closets.

Amended by
G.G. 29/6/84,
p. 1781.

45. Chemical closet pans and the sanitary powders or sanitary fluids associated therewith shall not be installed or used without the approval of the Executive Director, Public Health.

DIVISION 6.—DISPOSAL OF CONTENTS OF SEPTIC TANK AND OTHER RECEPTACLES FOR DRAINAGE.

46. (1) Where a septic tank or receptacle for drainage requires emptying and cleansing, the local authority may order the occupier, or the owner of the premises on which the septic tank or receptacle for drainage is situated, to have the emptying or cleansing carried out in such a manner and within such time as is specified in the order.

(2) Any person who fails to comply with an order of a local authority made under this regulation commits an offence.

DIVISION 7.—DISPOSAL OF EFFLUENT AND LIQUID WASTES.

47. Every apparatus shall be provided with an approved receptacle for drainage for the efficient disposal of effluent and in the case of separate systems, the liquid wastes from the premises shall also be provided with an approved receptacle for drainage.

48. Where nightsoil is disposed of by means other than deep sewerage or bacteriolytic treatment tanks, every premises so served shall be provided with an approved receptacle for drainage for the efficient disposal of liquid wastes.

49. The approved receptacle for drainage referred to in regulations 47 and 48 of this Division shall—

- (a) be constructed in accordance with the requirements shown on the plan and specifications issued with the permit and set out in Schedule "F" to these regulations;
- (b) be to the dimensions, and be located where, approved by the local authority;
- (c) be constructed so that effluent or liquid wastes will not be discharged into the ground at a distance less than 30 m from any well, stream or underground source of water intended or available for consumption by humans or animals; and
- (d) not be constructed within 6 m of any sub soil drainage system or open drainage channel.

Amended by
G.G. 29/6/84,
p. 1781.

50. (1) All effluent and liquid wastes from premises shall be conducted by means of an earthenware drain, or a drain of other approved material installed in accordance with the by-laws made under the Metropolitan Water Supply, Sewerage, and Drainage Act 1909, or the Country Towns Sewerage Act 1948—

- (a) direct into a soak well or soak wells complying with the following provisions—
 - (i) a sketch plan showing design, situation and construction of the soak well or wells together with the connections with the soak well, or soak wells, shall be submitted to and approved in writing by the local authority;
 - (ii) the soak well shall be at least 1.2 m in diameter and 1.5 m effective depth, unless otherwise approved in writing by the local authority;
 - (iii) where there is a series of more than one soak well, the earthenware drain from the house shall connect with only one of those wells, and the connection between the well into which the connection discharges and subsequent wells shall be by means of a long square junction on the outlet pipe;

15

- (iv) any combined system shall have at least two soak wells; and
 - (v) the soak well shall not be situated closer than 1.8 m to any boundary of a lot, building, septic tank or other soak well, unless otherwise approved by the local authority;
- (b) into an approved ventilated impervious receptacle fitted with a gas-tight cover, which complies with the following conditions—
- (i) the contents of the receptacle shall be removed at such times and with such frequency and in such manner as are directed by a health surveyor;
 - (ii) the occupier shall not permit the receptacle to overflow or become offensive;
 - (iii) the receptacle shall be situated where directed by a health surveyor;
 - (iv) where the contents of the receptacle are to be disposed of by pumping to some other outlet, the capacity of the receptacle shall be as approved by the Executive Director, Public Health and the receptacle shall be provided with an approved automatically operated electrically driven pump, permanently installed and equipped with an approved warning device;
 - (v) where the contents of the receptacle are to be disposed of by tanker, then the capacity of the receptacle shall be as directed by the local authority;
 - (vi) impervious receptacles shall be suitably anchored in the ground to prevent them from floating or otherwise moving when subjected to external hydrostatic pressure; and
 - (vii) the material used in the construction of an impervious receptacle shall be to the same specification as that for a septic tank of equivalent size;
- (c) into a french drain, which complies with the following conditions:—
- (i) a sketch plan showing the design, situation and construction, together with the connections with, the french drain shall be submitted to and approved by the local authority before construction is commenced;
 - (ii) the dimensions of the trench shall be determined by the health surveyor, using the formula set out in Schedule "G" of these regulations;
 - (iii) the french drain shall not be situated closer than 3.5 m from any dwelling, no closer than 6 m from any window or door of any dwelling, nor closer than 1.8 m from any boundary, unless otherwise approved by the local authority; and
 - (iv) the french drain, and all fittings connected thereto, shall at all times be maintained in good order and condition;
- (d) into a leach drain which complies with the following conditions:—
- (i) a sketch plan of the proposed leach drain showing details of construction, dimensions, levels and situation and connections to be made shall have been submitted to and approved by the local authority before construction is commenced;
 - (ii) the drain shall have a 610 mm overall width;
 - (iii) the dimensions of the trench shall be determined by the health surveyor using the formula set out in Schedule "G" of these regulations, provided that no drain shall have a greater effective depth than 610 mm;
 - (iv) the drain shall be constructed of good quality bricks laid with open joints and having the top three courses or all courses above the overt of the inlet set in 6-1-1 mortar, or of precast concrete and concrete masonry segments which comply with the standard for blocks, Class A., A.S., A87-1963 and having all courses above the overt of the inlet set in 6-1-1 sand cement and lime mortar;
 - (v) the bed of the drain shall have a fall of 1 in 200 away from the inlet pipe;
 - (vi) a concrete slab shall be fitted into the bed beneath the inlet pipe to prevent scouring of the beds;

16

- (vii) bridging pieces shall be placed between the walls of the drain at not more than 1.2 m centres, and the bridging pieces shall have apertures equal to at least fifteen per cent of their surface area and be so positioned as to allow the free passage of liquids;
 - (viii) if the walls of the drain are constructed of bricks, the bridging pieces shall extend to the top of the drain;
 - (ix) the drain shall be fitted with 610 mm x 610 mm reinforced concrete slabs, 50 mm thick, the reinforcement shall be F.41 steel fabric over the whole slab and the joints shall be rebated and be grouted and sealed with weak mortar if the final earth cover is less than 150 mm;
 - (x) the drain shall not be situated closer than 1.8 m from any septic tank, building or boundary of a lot, unless otherwise approved by the local authority; and
 - (xi) the leach drain, and all fittings connected thereto shall at all times be maintained in good order and condition, and when required by a health surveyor any leach drain shall be emptied, cleaned and rebuilt in such manner and within such time as may be specified in the requisition;
- (e) into an evaporation drain which complies with the following conditions:—
- (i) the trench shall be not less than 9 m long, of level grade, surround filling consisting of 50 mm or 75 mm gauge broken blue metal or approved gravel particles; filling on top to be of sharp, clean sand over a layer of paper or other similar material, but not water-proof;
 - (ii) a sketch plan showing design, situation and construction of the type of drain provided shall have been submitted to and approved by the local authority before construction is commenced;
 - (iii) the dimensions of the trench shall be determined by the health surveyor provided that no drain shall have a greater effective depth than 610 mm.
 - (iv) the profile shall be fibreglass or plastic of corrugated construction with a curved roof and shall be within the dimensional range of 230 mm to 610 mm in height and 450 mm to 610 mm in width and of sufficient strength to withstand a load of 7 kPa applied vertically on the roof.
Sufficient orifices of at least 5 per cent of the surface area shall be built into both vertical sides and so constructed as to prevent stone, sand, or gravel ingress from the outside and a bearing flange of moulded construction shall be built into the bottom of the vertical sides.
 - (v) the minimum property requirements of fibreglass sheeting shall comply with paragraph (g) of regulation 36 of these regulations; and
 - (vi) plastic manufacture shall be in accordance with the approval of the Executive Director, Public Health; or
- (f) into a waste stabilization pond constructed in accordance with plans, specifications and dimensions approved by the Executive Director, Public Health and complying with the following conditions—
- (i) the pond shall have an effective depth of 1.07 m unless otherwise approved by the Executive Director, Public Health;
 - (ii) the sides shall have a slope of 3 : 1;
 - (iii) the bank shall have a minimum width of 2.4 m, and shall be raised at least 228 mm above natural ground level;
 - (iv) the inner banks shall be kept clear of weed growth at all times;
 - (v) all overflow channels and drainage areas shall be kept free of weed growth; and
 - (vi) the pond shall be surrounded with a 1.8 m wire mesh fence, with a locked access gate.

(2) Where a grease intercepting trap, soap trap, junction box, distribution pit, or any other approved fitting, is considered necessary by a health surveyor for the efficient functioning of the receptacle for drainage, it shall be installed at the premises and situated where directed by the health surveyor.

17

(3) The provision and repair, but not the maintenance and cleansing, of a receptacle for drainage as referred to in this regulation shall be the responsibility of the owner of the premises whereon the receptacle for drainage is provided or to be provided.

DIVISION 8.—MANUFACTURING.

51. (1) Any person who manufactures for sale any article intended for use in the installation of an apparatus for the bacteriolytic treatment of sewage, or receptacle for drainage, shall apply to the Executive Director, Public Health for registration of a mark or distinguishing brand to be used for the purposes of this Division. Amended by
G.G. 29/6/84,
p. 1781.

(2) Every article intended for use in the construction of an apparatus for the bacteriolytic treatment of sewage shall be legibly marked with the name of the manufacturer or his registered mark or brand.

(3) The name, mark or brand referred to in subregulation (2) of this regulation shall be moulded into the article at the time of casting or shall be marked by the use of a stencil with a durable branding material before the article is removed from the factory.

(4) Every septic tank shall, immediately the moulds are removed, have the words "inlet" and "outlet" stencilled above their respective openings on the inside of the pipe.

(5) Every septic tank shall be marked legibly with the date of its manufacture.

(6) Concrete segments intended for use in any apparatus shall be so stacked that each day's manufacture is segregated from any other day's manufacture, and each stack shall be clearly labelled with the date of manufacture and be visible at all times to a purchaser or inspecting officer.

52. A person shall not sell any article intended for use as a septic tank, receptacle for drainage or lid thereof unless the article has been continuously wet cured for at least seven days, or alternatively steam cured at 75°C for a minimum of 8 hours, and no such article shall be removed from the factory within fourteen days.

53. A manufacturer of any article intended for use in the installation of any apparatus for the bacteriolytic treatment of sewage or receptacle for drainage who refuses to sell to a person, authorized in that behalf by the Executive Director, Public Health, any such article or sample or portion thereof commits an offence. Amended by
G.G. 29/6/84,
p. 1781.

Schedule "A".

The Executive Director, Public Health and Scientific Support Services—Perth.

APPLICATION FOR INSTALLATION OF SEPTIC TANK.

Please Read Carefully.

(a) The applicant for any septic tank installation shall complete the application to the Executive Director, Public Health and Scientific Support Services on this page. Then insert carbon paper between page 5 and 7 and draw an accurate block plan with figured dimensions of the proposed installation, a copy of which will then be imprinted on page 7.

(b) If your plans are approved by the Executive Director, Public Health and Scientific Support Services, he will notify you and the local council.

Do not start work on this installation until you have this approval. (Penalty \$100.)

(c) When you have the approval you may proceed with the installation. Before sealing the septic tank, or covering the drains, notify your local health surveyor, so that he may inspect and test the installation.

(d) A fee of \$10 should accompany each application. Cheques etc., to be made payable to the Executive Director, Public Health and Scientific Support Services.

Amended by
G.G. 18/12/81,
p. 5192;
G.G. 29/6/84,
p. 1781.

Schedule A.—*continued.*

1. Owner (block letters)
 Address where apparatus is to be constructed.
 Lot No.
 Street
 House No.
 Town Council
2. Nature of Premises (e.g., house, shop, factory, flat, etc.)

3. Number of persons residing or employed
4. Number of bedrooms
5. Type of apparatus. Sewage only or Combined
 Construction—Rectangular or Circular
6. Type of flushing cistern—10 litres, 3.5 litres, 1.13 litres
7. Name and address of Plumbing Contractor
 Phone No.
8. Name and address for return of approved plans
9. Drawn in duplicate is a block plan of the premises on which the position of the proposed septic tank and all drains, inspection openings, vents, traps and junctions and distances from boundaries, etc., are accurately indicated by figured measurements.
 Signature Date

HEALTH DEPARTMENT USE ONLY.

Official Stamp

Approval No.	Circular	Rectangular
Receipt No.	A. 1 520 mm	A.m.....mm
Fee	B. 1 220 mm	B.m.....mm
Capacity	C. 1 065 mm	C.m.....mm
		D.m.....mm

—————
 This page to be completed by the Local Authority Health Surveyor.
 Location—(e.g., 3rd lot on the left south of Brown Street)
 Nature of Soil (e.g., clay, sand, gravel, loam, etc.)
 Water Supply—Source of supply and if permanent
 Type of disposal and dimensions—

Recommendations to the Executive Director, Public Health and Scientific Support Services.
 Recommended—(Conditions):

 Health Surveyor Date
 Local Health Authority
 Recorded and Recommended.
 Date Departmental Health Surveyor

19

SPECIFICATION.

GENERAL: All materials, pipes, bends, junctions, fittings, fixtures and apparatus shall be sound and free from defects and shall be approved and installed in accordance with the by-laws and practices of the Metropolitan Water Supply, Sewerage and Drainage Board, and Country Towns Sewerage Branch.

PRECAST CYLINDRICAL TANK: To be constructed as shown on plan, of concrete, minimum 50 mm thick, reinforced as specified in Division "3" of the Bacteriolytic Treatment of Sewage Regulations. Joints of mesh shall be securely tied with a full two mesh overlap, or welded. Mesh to have at least 20 mm cover. Tank to be finished to a smooth surface internally. Bottom of tank to be of 100 mm concrete, extending 75 mm beyond the walls. Baffle to be 50 mm concrete reinforced with F.41 steel mesh. It shall be fastened securely to the walls. Inlet and outlet shall be by means of earthenware squares set out from the wall and fixed securely. Invert of inlet to be 100 mm above the invert of the outlet.

RECTANGULAR TANK (Built *in situ*): To be constructed as shown on plan and have—

- (a) walls of a minimum 230 mm brickwork set in 3 in 1 cement mortar and rendered internally with 2 in 1 cement mortar 12 mm thick. The Baffle to be of 115 mm brickwork and bonded into the walls or 50 mm reinforced concrete.
- (b) Walls of a minimum 125 mm reinforced concrete, with a 50 mm reinforced concrete baffle cast with the walls. Concrete to be compacted by vibration.

Bottom of septic tank to be of 100 mm concrete extending 75 mm beyond the walls on all sides. Inlet and outlet squares to be placed and secured in the same manner as the cylindrical tank above.

SEPTIC TANK COVERS: Septic tank covers shall be of concrete in sections with rebated joints. The concrete to be a minimum of 65 mm thick, reinforced with F.41 steel mesh fabric. Joints of mesh shall be securely tied with a full two mesh overlap, or welded.

Provide 150 mm diameter inspection openings over inlet and outlet squares. Covers to be clearly marked with manufacturer's identification.

DRAINS: Drain pipes shall be first quality, tested earthenware, socketed pipes of 100 mm diameter, laid with a uniform fall of 1 in 40. Pipes to be jointed with neoprene rings or 2 in 1 cement mortar, properly cleaned off on the inside and neatly splayed off after being solidly overfilled.

Joints to be covered with wet sand, until refilling of trench commences. All pipes and fittings shall be laid to such lines and grades and placed in the positions shown on the approved plans, or as may be directed by a health surveyor. All pipe lines shall be tested to the standard hydrostatic and mirror tests as laid down by the M.W.S.S. and D. Board, Perth.

SOAK WELL, LEACH, FRENCH OR EVAPORATION DRAINS: To be constructed in accordance with the Public Health Department plan and specification provided.

WASTE STABILIZATION POND: Constructed in an approved manner.

PEDESTAL PAN: To be tested glazed earthenware, as shown, secured by brass screws to lead dowels provided in the floor and fitted with a back vent where required by the M.W.S.S. and D. Board by-laws.

20

FLUSH PIPE: Shall be of approved material and bear the testing brand of the M.W.S.S. and D. Board and shall have the following minimum length and diameter:—

Low Level—length 230 mm and outside diameter 50 mm.

Mid Level—length 530 mm and outside diameter 50 mm.

High Level—length 1 220 mm and external diameter 38 mm.

No flush pipe shall protrude past the opening to the flush rim.

FLUSHING CISTERN: To be of 10 litre capacity, giving a 10 litre flush unless otherwise approved. Cistern to be secured to wall by means of approved steel brackets and bolts.

FLOOR: To be concrete 100 mm thick, laid with a fall of 1 in 24 to an approved floor waste.

EDUCT VENT PIPE: To be 100 mm in diameter and 0.914 mm galvanised iron, tarred internally or asbestos, copper or other approved material taken off an earthenware square as shown, or 90° bend. To be not less than 5.5 m high and fitted with approved mosquito proof cowl. Pipe to be secured to wall plate with two wrought iron clips and bolts as shown on plan, but clips used in conjunction with copper pipe shall be plastic coated. Bottom of pipe to be blocked in cement to a height of 150 mm above ground level, the top of the cement to be weathered to a 45° angle.

WATER SUPPLY: Water supply pipes to cistern shall be adequate to fill any cistern at the rate of not less than 5 litres per minute when one other tap on the service is turned full on.

SPECIFICATION FOR CONCRETE: Mix 355 kg cement per cubic metre of concrete.

W/C ratio 21 litres of water per 40 kg bag of cement (approx.). Aggregate to comply with A.S. A77-1957. Compaction by spinning or vibration.

HEALTH DEPARTMENT OFFICE USE.

Approval No.		Dimensions	Official Stamp
Receipt No.	Circular	Rectangular	
	A. 1 520 mm	A.m.....mm	
	B. 1 220 mm	B.m.....mm	
	C. 1 065 mm	C.m.....mm	
		D.m.....mm	

To be completed by Applicant.

NAME (Block Letters)
 LOT No. Street Town

BLOCK PLAN (not less than 1:100 scale).

Amended by
 G.G. 29/6/84,
 p. 1781.

Schedule "B".

Reg. 10 (2).

Health Act 1911.

CERTIFICATE OF CONSTRUCTION OF SEPTIC TANK.

Mr.
 Lot
 At
 House Approval No.
 Street Town

I certify that this septic tank installation has been inspected and completed in accordance with the plan and specifications approved by the Executive Director, Public Health and Scientific Support Services.

HEALTH SURVEYOR Date
 LOCAL HEALTH AUTHORITY

CONCRETE COVERS FOR INSITU SEPTIC TANKS

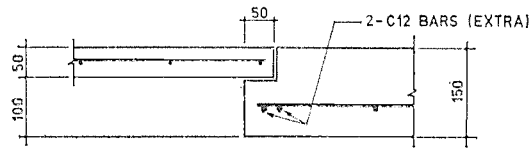

DETAIL A

FABRIC AS INDICATED IN REIN. SCHEDULE

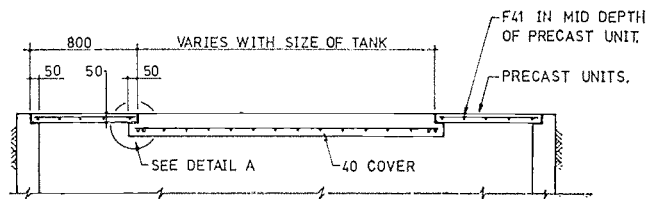

SECTION THRU PRECAST & INSITU COVERS

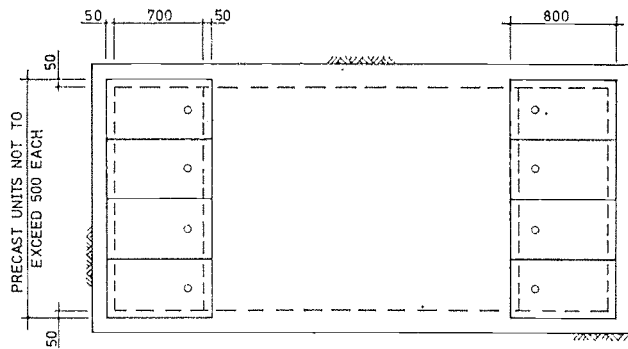

PLAN OF TYPICAL TANK COVERS

- NOTE:-
- 1 ALL DIMENSIONS ARE IN MILLIMETRES.
 - 2 STRUCTURAL NOTES AS FOR 2000 DEEP TANK.

DIAGRAM 1

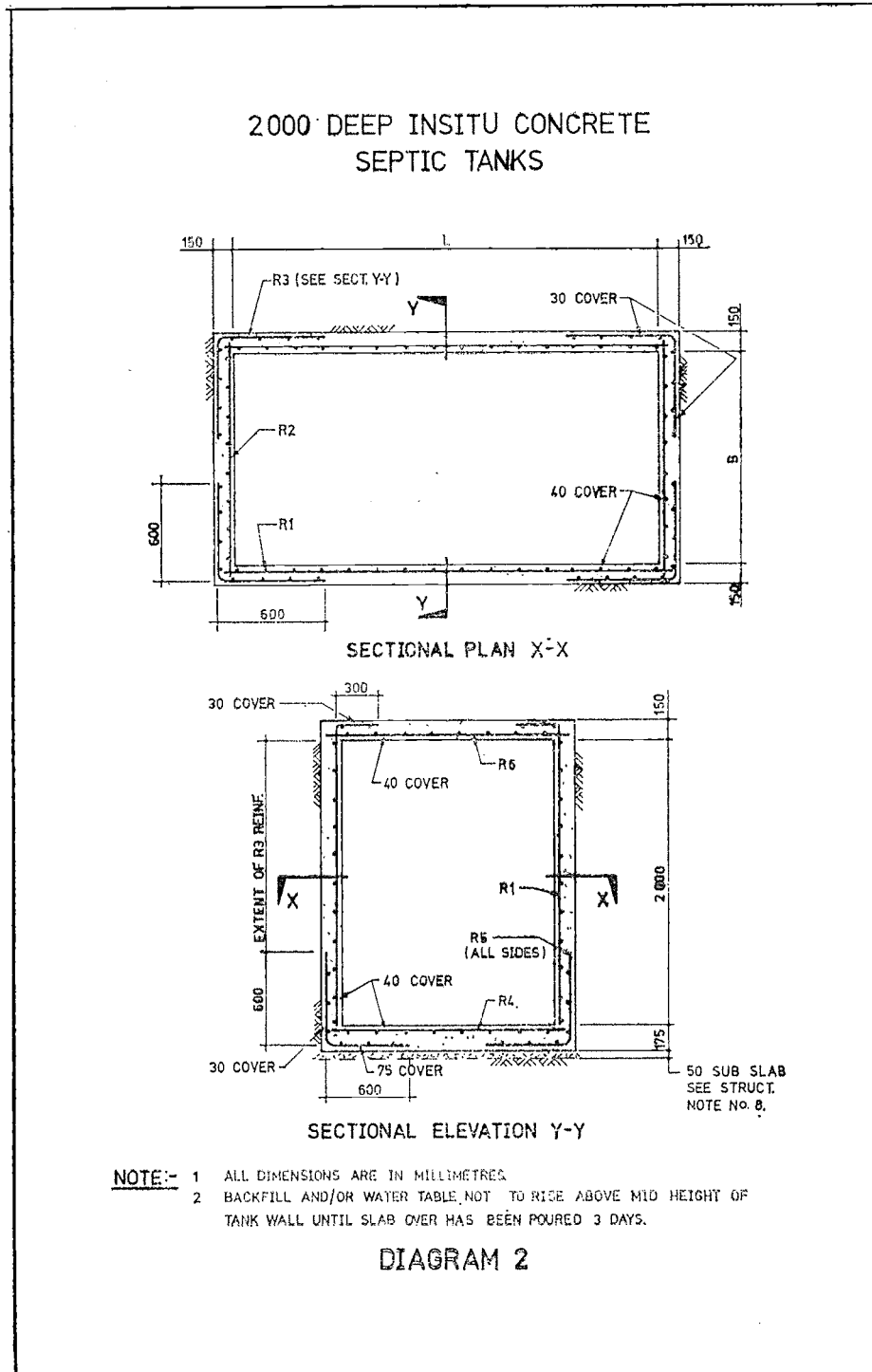

25

DEPTH 2 000

L x B	FABRIC REINFORCEMENT FOR 2 000 DEEP TANK					
	R1	R2	R3	R4	R5	R6
3 000 x 1 500	F82	F82	F82	F92	F82	F92
3 600 x 1 900	F82	F82	F82	F92	F82	F92
4 200 x 2 200	F82	F82	F82	F92	F82	F92
4 800 x 2 500	F82	F82	F82	F102	F82	F102
5 500 x 2 800	F82	F82	F82	F81	F82	F81

STRUCTURAL NOTES

- 1 ALL DIMENSIONS ARE IN MILLIMETRES.
- 2 CONCRETE TO BE GRADE 25.
- 3 MAX. SLUMP (A) IN WALLS TO BE 100mm.
(B) IN COVERS AND FLOOR TO BE 30mm.
- 4 CONCRETE WORK TO BE CARRIED OUT IN ACCORDANCE WITH S.A.A. CODE AS 1480.
- 5 ALL FABRIC IS TO COMPLY WITH A.S. NO. 1304
- 6 CONCRETE TO BE PLACED USING VIBRATORS.
- 7 REINF. TO BE HELD IN PLACE USING PLASTIC TIPPED WIRE CHAIRS.
- 8 UNREINFORCED CONCRETE SUB SLAB 50mm. THICK MAY BE USED UNDER STRUCTURAL
BASE SLAB IF REQUIRED BY UNFAVOURABLE SOIL CONDITIONS.
- 9 THIS DRG. TO BE READ IN CONJUNCTION WITH PLAN AND SPEC. ON APPLICATION FORM
- 10 ALL CODES MUST BE LATEST EDITION WITH ALL AMENDMENTS ATTACHED.

ALTERNATIVE REINFORCEMENT

L x B	BAR REINFORCEMENT FOR 2 000 DEEP TANK					
	R1	R2	R3	R4	R5	R6
3 000 x 1 500	C12 AT 400 EW.	C12 AT 400 EW.	C12 AT 400 EW.	C12 AT 300 EW.	C12 AT 400 EW.	C12 AT 300 EW.
3 600 x 1 900	AS ABOVE	AS ABOVE	AS ABOVE	AS ABOVE	AS ABOVE	AS ABOVE
4 200 x 2 200	AS ABOVE	AS ABOVE	AS ABOVE	AS ABOVE	AS ABOVE	AS ABOVE
4 800 x 2 500	AS ABOVE	AS ABOVE	AS ABOVE	C12 AT 250 EW.	AS ABOVE	C12 AT 250 EW.
5 500 x 2 800	AS ABOVE	AS ABOVE	AS ABOVE	C12 AT 200 EW.	AS ABOVE	C12 AT 200 EW.

LEGEND

- C COLD TWISTED DEFORMED BARS IN ACCORDANCE WITH AS 1002.
EW. EACH WAY.

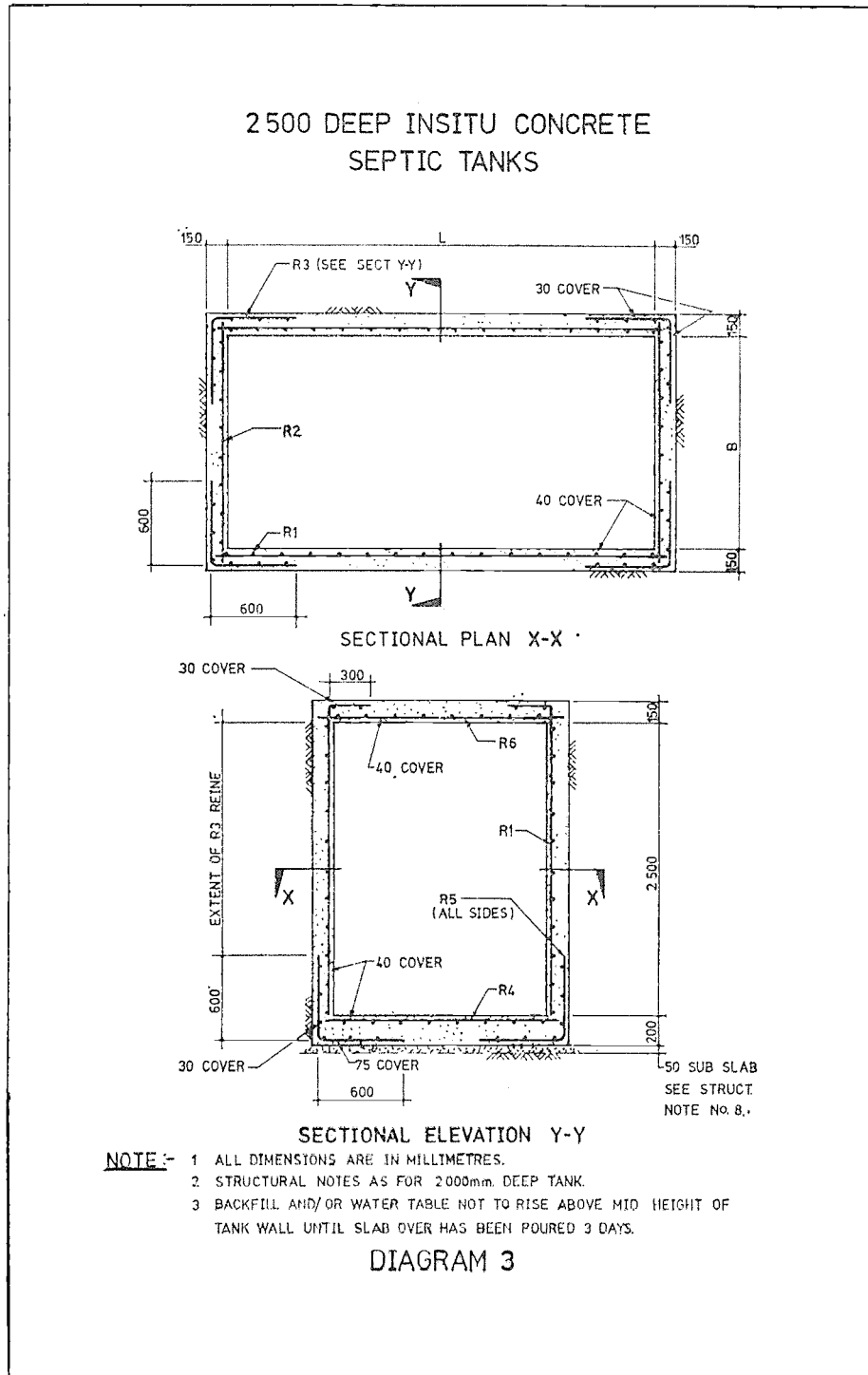

27

DEPTH 2 500

L x B	FABRIC REINFORCEMENT FOR 2 500 DEEP TANK					
	R1	R2	R3	R4	R5	R6
3 000 x 1 500	F92	F92	F92	F92	F92	F92
3 600 x 1 900	F92	F92	F92	F92	F92	F92
4 200 x 2 200	F92	F92	F92	F92	F92	F92
4 800 x 2 500	F92	F92	F92	F102	F92	F102
5 500 x 2 800	F92	F92	F92	F81	F92	F81

ALTERNATIVE REINFORCEMENT

L x B	BAR REINFORCEMENT FOR 2 500 DEEP TANK					
	R1	R2	R3	R4	R5	R6
3 000 x 1 500	C12 AT 300 EW	C12 AT 300 EW	C12 AT 300 EW	C12 AT 300 EW	C12 AT 300 EW	C12 AT 300 EW
3 600 x 1 900	AS ABOVE	AS ABOVE	AS ABOVE	AS ABOVE	AS ABOVE	AS ABOVE
4 200 x 2 200	AS ABOVE	AS ABOVE	AS ABOVE	AS ABOVE	AS ABOVE	AS ABOVE
4 800 x 2 500	AS ABOVE	AS ABOVE	AS ABOVE	C12 AT 250 EW	AS ABOVE	C12 AT 250 EW
5 500 x 2 800	AS ABOVE	AS ABOVE	AS ABOVE	C12 AT 200 EW	AS ABOVE	C12 AT 200 EW

LEGEND

C COLD TWISTED DEFORMED BARS IN ACCORDANCE WITH A.S.1302.

EW. EACH WAY

3 000 DEEP INSITU CONCRETE SEPTIC TANKS

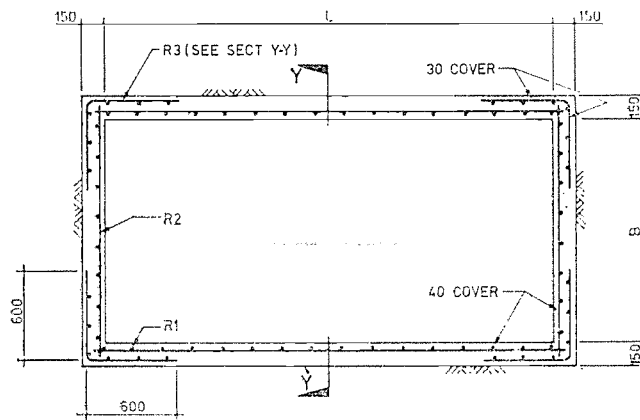

SECTIONAL PLAN X-X

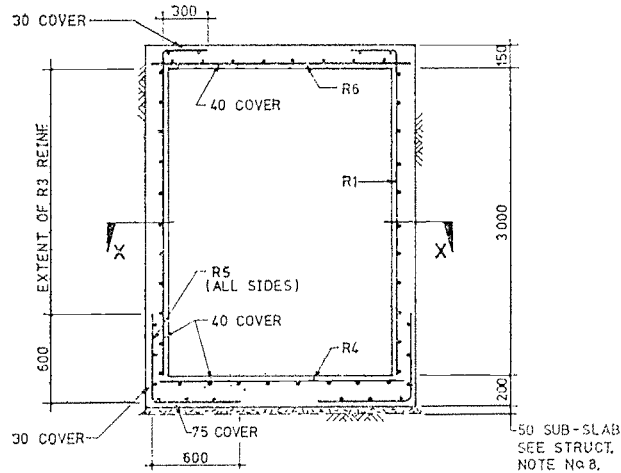

SECTIONAL ELEVATION Y-Y

- NOTE:-**
- 1 ALL DIMENSIONS ARE IN MILLIMETRES.
 - 2 STRUCTURAL NOTES AS FOR 2000mm DEEP TANK.
 - 3 BACKFILL AND/OR WATER TABLE NOT TO RISE ABOVE MID HEIGHT OF TANK WALL UNTIL SLAB HAS BEEN POURED 3 DAYS.

DIAGRAM 4

DEPTH 3 000

L x B	FABRIC REINFORCEMENT FOR 3 000 DEEP TANK					
	R1	R2	R3	R4	R5	R6
3 000 x 1 500	F92	F92	F92	F92	F92	F92
3 600 x 1 900	F92	F92	F92	F92	F92	F92
4 200 x 2 200	F102	F92	F92	F102	F92	F102
4 800 x 2 500	F102	F92	F92	F102	F92	F102
5 500 x 2 800	F81	F92	F92	F81	F92	F81

ALTERNATIVE REINFORCEMENT

L x B	BAR REINFORCEMENT FOR 3 000 DEEP TANK					
	R1	R2	R3	R4	R5	R6
3 000 x 1 500	C12 AT 300 E.W.	C12 AT 300 E.W.	C12 AT 300 E.W.	C12 AT 300 E.W.	C12 AT 300 E.W.	C12 AT 300 E.W.
3 600 x 1 900	AS ABOVE	AS ABOVE	AS ABOVE	AS ABOVE	AS ABOVE	AS ABOVE
4 200 x 2 200	C12 AT 250 E.W.	AS ABOVE	AS ABOVE	C12 AT 250 E.W.	AS ABOVE	C12 AT 250 E.W.
4 800 x 2 500	AS ABOVE	AS ABOVE	AS ABOVE	AS ABOVE	AS ABOVE	AS ABOVE
5 500 x 2 800	C12 AT 200 E.W.	AS ABOVE	AS ABOVE	C12 AT 200 E.W.	AS ABOVE	C12 AT 200 E.W.

LEGEND

- C COLD TWISTED DEFORMED BARS IN ACCORDANCE WITH A.S.1302.
E.W. EACH WAY

SCHEDULE 'C' REG 35
STRUCTURAL DETAILS OF BRICK SEPTIC TANK
 (SAND CONDITIONS ONLY)

NOTE:
 1 THIS DRAWING TO BE READ IN CONJUNCTION WITH PLANS AND SPECIFICATIONS ON APPLICATION FORM.
 2: ALL WALL INTERSECTIONS MUST BE FULLY BONDED. WIRE TIES AS A SUBSTITUTE FOR BONDING WILL NOT BE PERMITTED

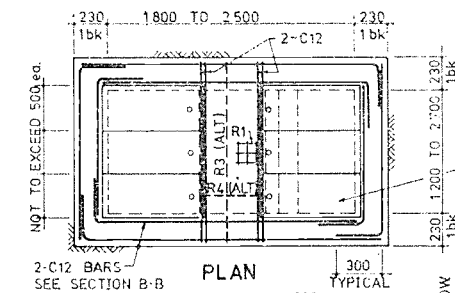

PRECAST COVERS TO BE DESIGNED FOR LIVE LOAD OF 7 kn/m²

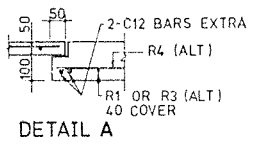
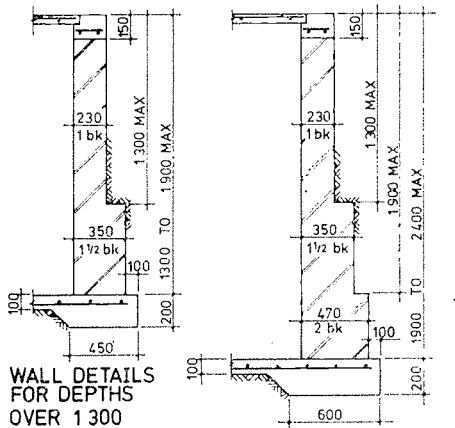
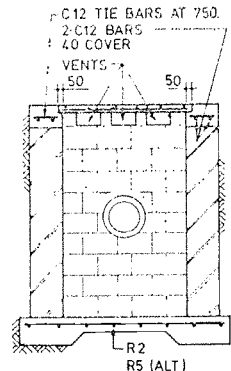
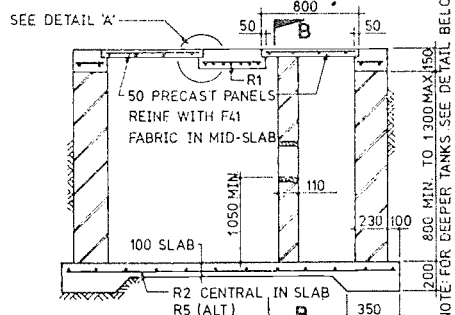

REINFORCEMENT	
FABRIC	ALTERNATE BAR REINF.
R1	F81
R2	F82
R3	C12 AT 150 (BOTTOM)
R4	C12 AT 300 (TIES)
R5	C12 AT 300 EW

- GENERAL NOTES:**
- 1 ALL DIMENSIONS ARE IN MILLIMETRES.
 2. ALL CONCRETE TO BE GRADE 25.
 3. C= COLD TWISTED DEFORMED BARS IN ACCORDANCE WITH AS1302.
 4. EW= EACH WAY
 5. ALT.= ALTERNATIVE

31

Schedule "D".

Reg. 41. Amended by G.G. 29/6/84, p. 1781.

Form No. 1.

HEALTH ACT 1911.

Bacteriolytic Treatment of Sewage and Disposal of Effluent and Liquid Waste Regulations.

APPLICATION FOR TESTING OF SANITARY FIXTURES AND FITTINGS.

To the Executive Director, Public Health and Scientific Support Services:

It is requested that you arrange for the articles specified hereunder to be tested for approval in accordance with the Health Act 1911.

I undertake to pay the prescribed fee for the service on demand.

Articles:

Description:

Number:

Location:

Signature of Applicant:

Date:



Form No. 2.

HEALTH ACT 1911.

Bacteriolytic Treatment of Sewage and Disposal of Effluent and Liquid Waste Regulations.

CERTIFICATE OF APPROVAL.

This Certificate of Approval is granted in respect of the type of article described hereunder in accordance with the Health Act 1911.

.....
.....
.....
.....

Issued at Perth, this day of , 19....

.....
EXECUTIVE DIRECTOR,
PUBLIC HEALTH AND
SCIENTIFIC SUPPORT
SERVICES.

32

SCHEDULE "E"
DRY TYPE SEPTIC TANK.

REG. 43

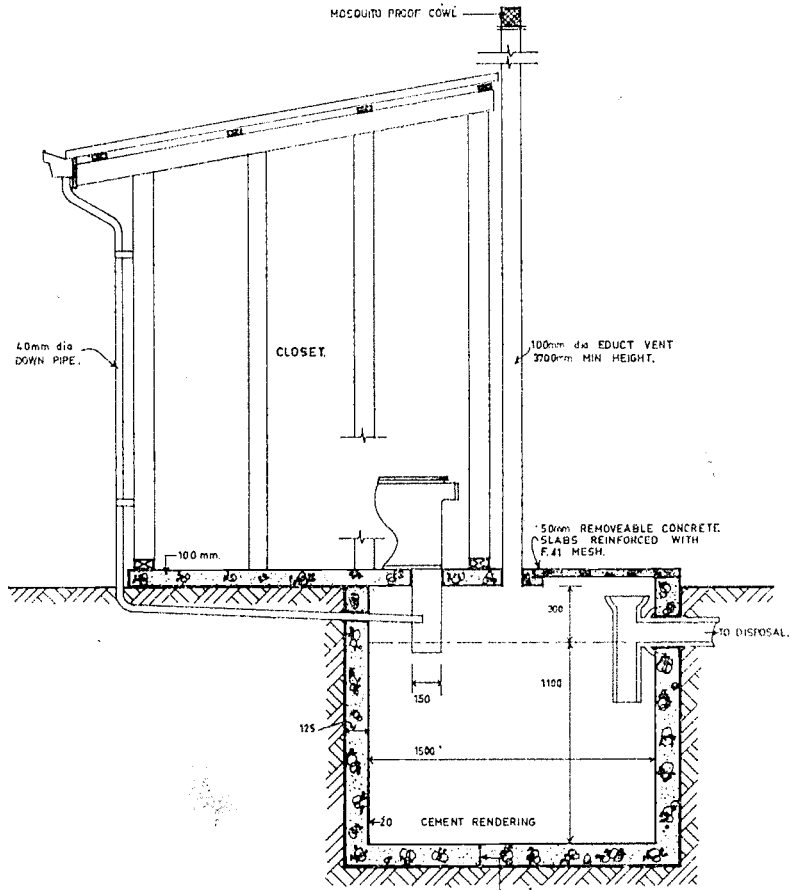

SECTION A-A.

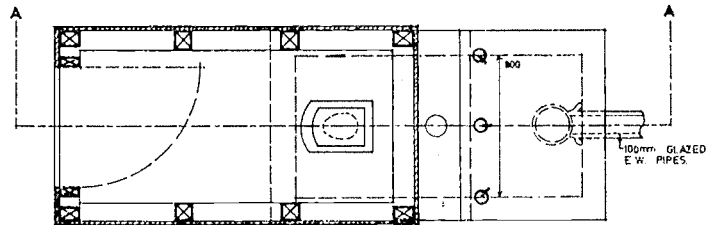

PLAN.

SCHEDULE "F"

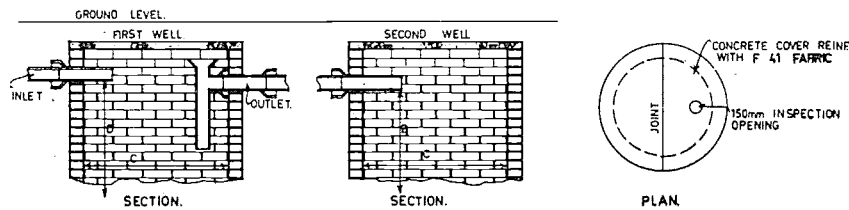

SOAKWELL SPECIFICATION

'D' & 'C' TO BE AT COURSE HEIGHT BUT NOT LESS THAN 1200 FOR 'C' AND 1500 FOR 'D'

Soak Well—To be constructed as shown on plan, having the three top courses or all courses above the overt to be set in 2 in 1 cement mortar, the remainder in open jointed brickwork, laid dry, in stretcher courses, or constructed in approved cement segments or bricks which comply with the standard for blocks, class A. A.S. A87-1963.

Size—Bricks or segments shall have a minimum bearing face of 100 mm and shall be laid over the full bearing face in each course.

Sufficient openings shall be provided in any soak well to allow for the efficient disposal of the effluent, and shall be not less than 10% of the surface area.

Inspection Openings and square junction to be provided as shown.

When completed it shall show a circular, smooth and regular internal surface.

All soak wells shall be 1.2 m in dia. and with a 1.5 m effective depth unless otherwise specified or approved by the Local Authority.

The top of the soak well shall not be more than 300 mm or less than 150 mm below ground level, unless otherwise approved by the Local Authority.

Soak wells in series shall have a long square on the outlet as shown.

Cover—Shall be of concrete in section with rebated joint as shown, reinforced with No. F.41 steel mesh fabric, joints of mesh shall be securely tied with a full two mesh overlap, unless otherwise specified.

The covers shall withstand a flexural test of 2 MPa and a load bearing of 7 kPa.

Traffic covers shall be constructed to specific Departmental specifications.

No soak well shall be situated closer than 1.8 m to any building, boundary fence or septic tank, unless otherwise approved by the Local Authority.

SCHEDULE "F" Form No. 2.

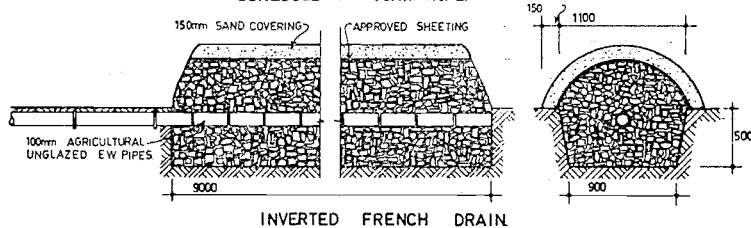

INVERTED FRENCH DRAIN

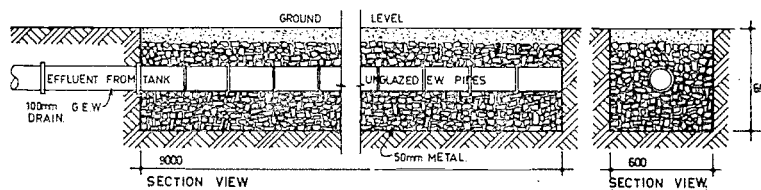

STANDARD FRENCH DRAIN

Specifications.

Trench to be not less than 9 m long, constructed as shown.
 Filling to consist of 50 mm or 75 mm gauge broken blue metal; filling on top may be of smaller gauge metal with sand over approved sheeting.
 Distributing pipe to be 75 mm or 100 mm diameter unglazed agricultural pipes laid with open butt joints, or other approved piping.
 Grade shall be laid at not more than 1 in 200.
 A French drain shall not be situated closer than 3.5 m from any dwelling nor closer than 6 m from any window or door of any dwelling, nor closer than 1.8 m from any lot boundary, unless otherwise approved by the Local Authority.

SCHEDULE "F" Form. No. 3.

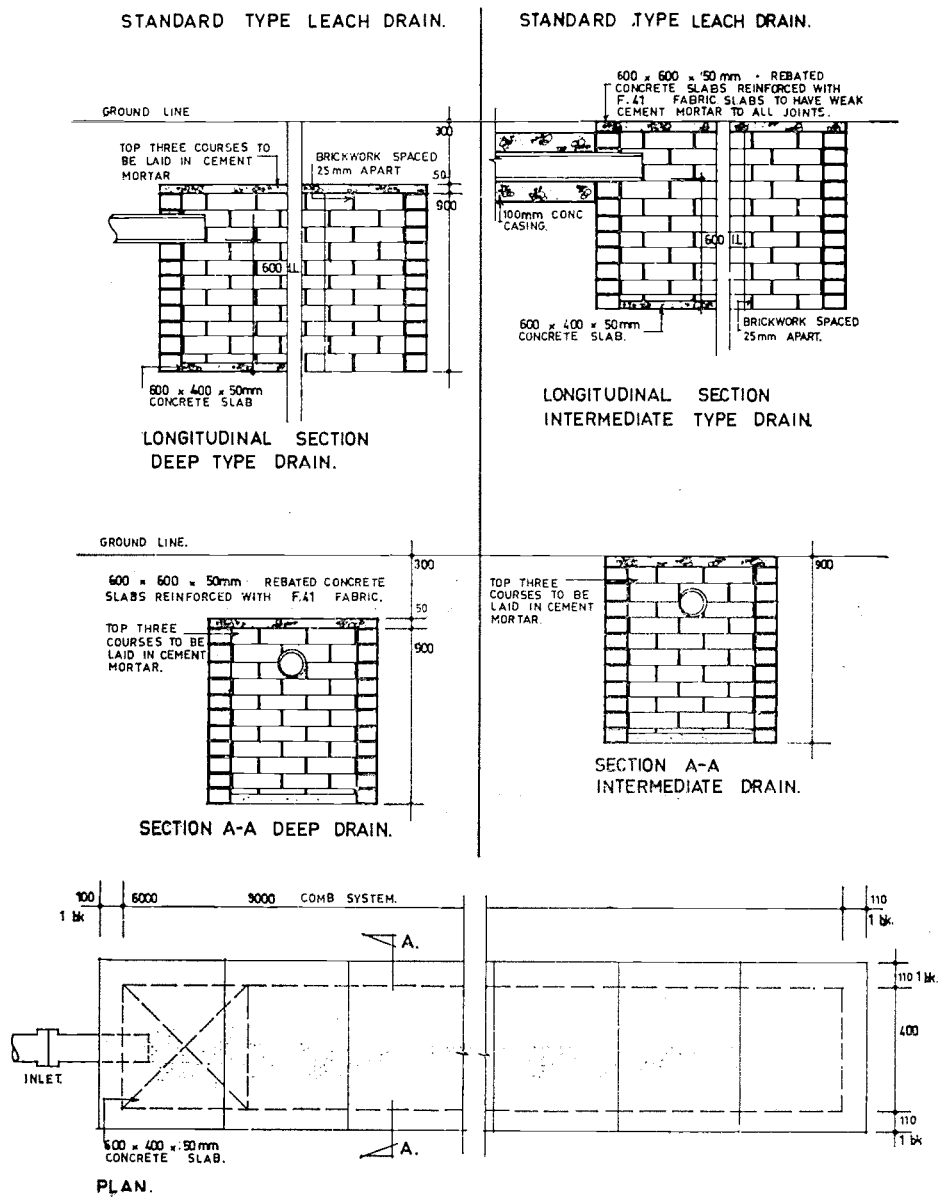

SEMI INVERTED TYPE LEACH DRAIN.

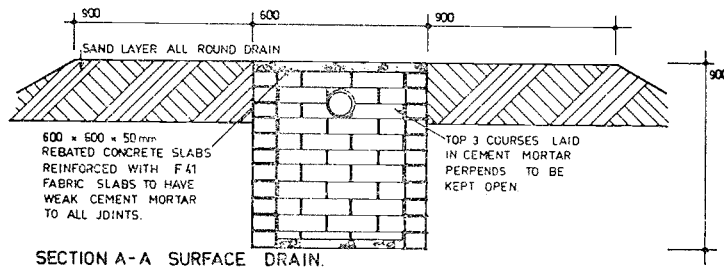
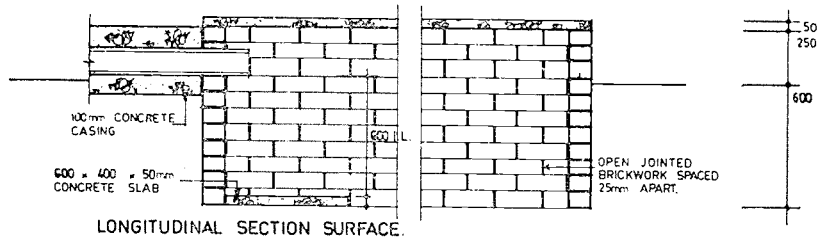

FULLY INVERTED TYPE LEACH DRAIN.

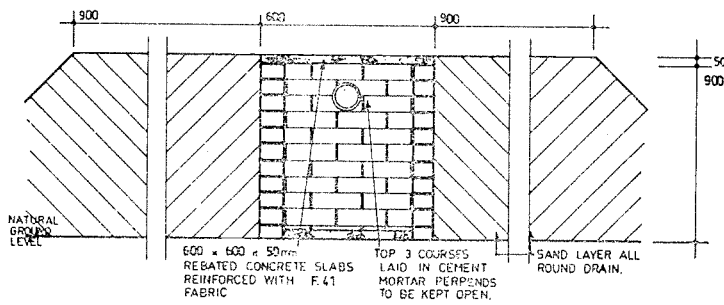
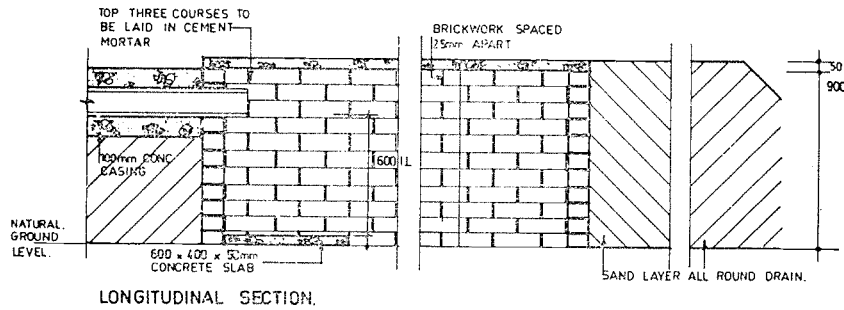

DETAILS OF LEACH DRAIN.

THE DRAIN SHALL NOT BE SITUATED CLOSER THAN 2000 FROM ANY SEPTIC TANK, BUILDING OR BOUNDARY OF A LOT UNLESS OTHERWISE APPROVED BY THE LOCAL AUTHORITY.
MINIMUM LENGTH SEPARATE SYSTEMS TO HAVE DRAIN 6000 LONG COMBINED SYSTEMS TO HAVE DRAIN 9000 LONG REINFORCED CONCRETE PAVING SLABS POSITIONED BENEATH INLET AND BRICK SPREADER WALLS PROVIDED NOT MORE THAN 1200 cts SEGMENTS WHERE SEGMENTS ARE USED ALL COURSES ABOVE THE OVERT OF THE INLET TO BE LAID 3:1 CEMENT MORTAR.

FORM N° 4.

EVAPORATION DRAIN

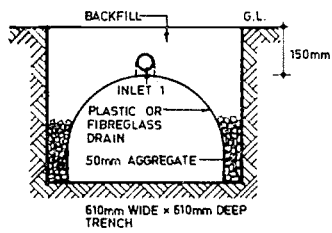

SECTION A-A

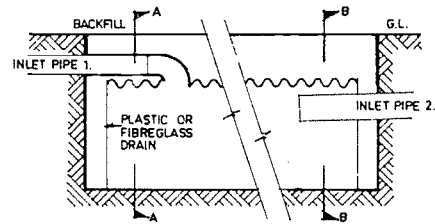

LONGITUDINAL SECTION

PLASTIC OR
FIBREGLASS DRAIN.

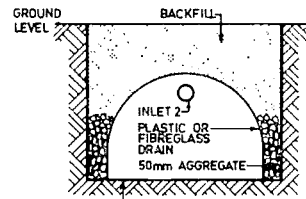

SECTION B-B

37

Schedule "G".

Health Department.

Amended by
G.G. 29/6/84,
p. 1781.

FORMULA FOR DETERMINING ABSORPTIVE CAPACITY OF A SOIL.

1. Dig a hole with dimensions of 300 mm square and vertical sides to the depth of the proposed absorption trench.
2. Carefully scarify the bottom and sides of the hole in order to remove any smeared soil surfaces and to provide a natural soil interface into which the water may percolate. Remove all loose material from the hole. Add 50 mm of blue metal, or screened gravel, to protect the bottom from scouring and sediment.
3. Fill the hole with water and allow it to soak away. Preferably keep the hole filled overnight, possibly by means of an automatic siphon.
4. The following morning, fill or adjust water level to a depth of 150 mm above blue metal or gravel, insert measuring stick (as shown) and note time taken for water to fall 25 mm.

The amount of effluent which can be disposed of per square metre of trench bottom per day is given by the following table:—

Time for water to Fall 25 mm.	Dose per 0.09 square metre of Trench Bottom.
1 minute	14 litres
2 minutes	11 litres
5 minutes	10 litres
10 minutes	7 litres
30 minutes	3.5 litres
60 minutes	2 litres
Over 60 minutes	Soil unsuitable.

The use of a diversion pit and stop board to divert drainage from one line of drain to another is recommended where large quantities of water are to be disposed of into difficult soils.

