



Western Australia

Fish Resources Management Act 1994

# **Fish Resources Management Regulations 1995**

---

As at 01 Nov 2014

Version 12-m0-02

Extract from [www.slp.wa.gov.au](http://www.slp.wa.gov.au), see that website for further information



# Fish Resources Management Regulations 1995

## Contents

<b>Part 1 — Preliminary</b>		
1.	Citation	1
2.	Commencement	1
3.	Terms used	1
4.	Body prescribed (Act s. 4(1) <i>peak industry body</i> )	8
5.	Classes of fish prescribed (Act s. 4(1) <i>process</i> )	8
6.	Fee prescribed for exemption application (Act s. 7(4))	9
7.	Exemption, power to require return of	9
<b>Part 2 — Administration</b>		
8.	Common seal of Minister for Fisheries, use of etc.	10
<b>Part 3 — Advisory committees</b>		
9.	Procedure for appointments prescribed (Act s. 29(2), 33(2) and 37(2))	11
<b>Part 4 — General regulation of fishing</b>		
<b>Division 1 — Protected fish</b>		
10.	Classes of fish prescribed (Act s. 45)	12
11.	Defences etc. prescribed (Act s. 48)	12
12.	Totally protected rock lobsters and crabs to be released	13
13.	Mutilated etc. protected fish, possession of	14

	<b>Division 2 — Requirements regarding fish trunks and fillets</b>	
14A.	Term used: specified size	14
14.	Certain types of finfish, how to be landed	14
16B.	Sharks and rays, possession of by commercial fishers	16
	<b>Division 3 — Possession limits</b>	
	<b>Subdivision 1A — Preliminary</b>	
16C.	Term used: finfish	18
16CA.	Bag limits, application and effect of	18
	<b>Subdivision 1 — Possession limits Statewide</b>	
16D.	Finfish, general possession limit of (Act s. 51(1))	19
16E.	Fish on boats (Act s. 51(1))	19
16GA.	Rock lobster (Act s. 51(1))	24
16GB.	Barramundi (Act s. 51(1))	24
16GC.	Marron (Act s. 51(1), (2))	25
16GD.	Abalone (Act s. 51(1))	25
16GE.	Fish on fishing boats (commercial)	26
	<b>Subdivision 3 — Possession limits — pink snapper at Shark Bay</b>	
16G.	Terms used	27
16H.	Pink snapper in Freycinet Estuary area	28
16I.	Tags authorising possession of pink snapper in Freycinet Estuary area, application for and issue of	28
16J.	Form of tag issued under r. 16I	29
	<b>Subdivision 4 — Possession limits in Abrolhos Islands</b>	
16K.	Finfish in Abrolhos Islands reserve or Abrolhos Islands Fish Habitat Protection Area (Act s. 51(1))	30
	<b>Subdivision 5 — Miscellaneous</b>	
20.	Defence prescribed (Act s. 51(2))	30
21.	People presumed to be in possession of fish (Act s. 51)	30
	<b>Division 4 — Labelling of fish</b>	
22.	Labelling requirements for packed or stored fish	31
	<b>Division 5 — Requirements regarding rock lobsters</b>	
31.	Rock lobster: permitted ways to fish for and tail marking	33

31A.	Bait for rock lobster, limits on type of	35
32.	Rock lobster pot floats, requirements for	35
35.	Rock lobster flesh, possession of	36
36.	Boats (not fishing boats) used to fish for rock lobsters, rules for	37
37.	Offences against r. 36, defences for	38
38.	Rock lobster pots, requirements for	38
	<b>Division 5A — Requirements regarding deep sea crabs</b>	
38A.	Term used: deep sea crab	42
38B.	Possession and sale of parts of deep sea crabs	42
38C.	Parts of deep sea crabs not to be landed	43
	<b>Division 5B — Requirements regarding abalone and sea urchins</b>	
38D.	When fishing for abalone and sea urchins allowed	43
38E.	Diving for abalone using breathing apparatus prohibited in Abalone Zone 1	44
38F.	Use of abalone material as bait	44
38GA.	Possession of abalone material	44
	<b>Division 5C — Requirements regarding marron</b>	
	<b>Subdivision 1 — Interpretation</b>	
38G.	Terms used	45
	<b>Subdivision 2 — General restrictions on fishing for marron</b>	
38H.	Marron, permitted ways to fish for	47
38I.	Single marron pole snare only to be used in some waters	47
38J.	Marron fishing prohibited in certain Margaret River waters	48
38K.	Marron fishing prohibited from boats or by swimming or diving	48
38L.	Marron nets not to be transported in boats in most cases	49
	<b>Subdivision 3 — Closed season restrictions relating to marron</b>	
38M.	Closed season for marron fishing	49
38N.	Removing marron from private land in closed season	49
38O.	Possession of marron during non-possession period	50

<b>Division 6 — Requirements relating to the taking of certain fish</b>		
39.	Prawns, permitted ways to fish for by recreational fishers	51
40.	Cherabin, permitted ways to fish for	52
41.	Abalone, who may shuck or possess when shucked	52
42.	Molluscs (not abalone or oyster), shucking of	53
43.	Trout, obstructing etc.	54
44.	Barramundi, trout, freshwater cobbler and redfin perch, permitted ways to fish for	54
44A.	Freshwater fish, closed season for	55
45.	Demersal scalefish in West Coast Region, closed season for recreational fishing for	56
<b>Division 7A — Requirements relating to automatic location communicators</b>		
55A.	Terms used	57
55AA.	ALCs, approval of; directions for use of etc.	58
55B.	ALC, CEO may direct installation of etc. in fishing boat	58
55C.	Master of fishing boat, duties of as to ALC	59
55D.	Interfering etc. with ALC or approved seal	60
<b>Division 7B — Requirements relating to bait bands</b>		
55E.	Terms used	60
55F.	Bait bands on boats prohibited	61
<b>Division 7C — Requirements relating to aquatic eco-tourism</b>		
55G.	Activities and fish prohibited on aquatic eco-tour	62
55H.	Shark tourism activities prohibited on aquatic eco-tour	62
55I.	Boat not to be used for both commercial fishing and aquatic eco-tour during single trip	63
<b>Division 8 — Miscellaneous requirements</b>		
56.	Documents to be carried on licensed fishing boat	63
56A.	Fish hooks attached to rock lobster pots, float lines, moorings etc. not to be used to fish	64
59.	Sale of fish by authorised trade names	64
60.	Rock lobsters, maximum size of packages etc. of	65
61.	Fish for sale etc., labelling requirements for	65

62.	Refuse etc. not to be deposited in waters etc. where fish are	67
63A.	Use of berley containing mammal or bird products	67
63.	Fishing gear prohibited from use in waters, possession of	68
64.	Commercial fishers etc., duties of as to records and returns	69
64AA.	No fish taken for recreational purpose to be at certain premises	72

**Part 4A — Requirements regarding fishing gear**

**Division 1 — Preliminary**

64A.	Order of precedence of Div. 2, 3 and 4	73
64B.	Term used: attend	73

**Division 2 — Statewide requirements regarding fishing gear**

64CA.	Prohibited fishing methods	73
64C.	Fishing lines in use for recreational fishing must be attended	74
64D.	Nets, determining length, depth and mesh of	74
64DA.	Hauling nets for recreational fishing, use of	75
64E.	Lines etc. used for recreational fishing, limit on number of	75
64F.	Fishing nets, general requirements for	75
64G.	Fishing nets, minimum distance between when set	77
64H.	Fishing nets to be drawn so as to protect protected fish	77
64I.	Net fishing by commercial fishers in same area, priority rights between	77
64J.	Fishing nets for recreational fishing, use of	80
64K.	Hauling nets not to be used for recreational fishing in estuaries etc.	81
64L.	Crabs, permitted ways to fish for by recreational fishers	81

**Division 3 — Requirements regarding fishing gear in the West Coast Region**

64M.	Term used: attend	82
64N.	Application of this Division	82

64NA.	Prawn hand trawl nets not to be used in certain places	82
64O.	Set fishing nets, use of	83
64OAA.	Release weight to be on boat used to fish for demersal scalefish	83
<b>Division 3A — Requirements regarding fishing gear in the Pilbara and Kimberley Region</b>		
64OA.	Application of this Division	84
64OB.	Haul and set nets, restrictions on use of	84
<b>Division 3B — Requirements regarding fishing gear in the South Coast Region</b>		
64OC.	Application of this Division	85
64OD.	Set fishing nets, use of	85
64OE.	Throw nets, use of	86
<b>Division 4 — Requirements regarding fishing gear in certain other areas</b>		
64P.	Prawn hand trawl nets, use of in Swan River and Leschenault Estuary	87
64Q.	Fishing nets, use of etc. by commercial fishers in certain areas	87
64S.	Certain fishing gear not to be possessed near certain rivers and dams	89
64T.	Landing nets, use of in certain rivers and dams	91
<b>Part 4B — Bag limits</b>		
<b>Division 1 — Preliminary</b>		
64W.	Defences prescribed (Act s. 50(3))	92
64X.	Bag limits, application of	92
<b>Division 2 — Bag limits</b>		
65A.	Bag limits for demersal finfish (regions other than West Coast region)	93
65B.	Bag limits for demersal finfish (West Coast region)	94
65C.	Bag limits for large pelagic finfish	94
65D.	Bag limits for nearshore or estuarine finfish	94
65E.	Bag limit for freshwater finfish	95
65F.	Bag limits for other finfish	95
65G.	Bag limits for crustaceans	95
65H.	Bag limits for molluscs and other invertebrates	96



<b>Part 5 — Fish processing</b>		
65.	Classes of fish prescribed (Act s. 82(2)(a))	97
66.	Fish processor's licences, conditions of	97
<b>Part 6 — Aquaculture</b>		
67.	Aquaculture leases, application for	99
68.	Classes of fish etc. prescribed (Act s. 91(a) and (d))	99
69A.	Classes of fish prescribed (Act s. 92A(4))	100
69.	Aquaculture licences, conditions of	101
<b>Part 7 — Noxious fish</b>		
70.	Species prescribed (Sch. 5 and Act s. 103)	104
<b>Part 8 — Designated fishing zones</b>		
71.	Fisheries officer may restrict activities etc. in zones	105
<b>Part 9 — Abrolhos Islands reserve</b>		
<b>Division 1 — Interpretation and application of Part</b>		
72.	Terms used	106
73.	Application of this Part	107
<b>Division 2 — Jetties</b>		
74.	Construction and modification of jetties and moorings	107
75.	Unauthorised use of jetties and moorings	107
<b>Division 3 — Buildings and facilities</b>		
76.	CEO may waive requirements of this Division	108
77.	Camps associated with rock lobster licences, transfer of etc.	109
78.	Camp not transferred etc. under r. 77 becomes unauthorised structure	110
79.	Building standards, owners' duties as to	111
80.	Minor structural changes to buildings, requirements for	112
81.	New buildings and major structural changes to buildings, requirements for	112
<b>Division 4 — Power and maintenance</b>		
84.	Water tanks etc., occupiers' duties as to	114
85.	Generators, installation and use of	114

Contents

---

86.	Machinery noise, fisheries officer's powers as to	115
	<b>Division 5 — Unauthorised structures and termination of tenancy</b>	
87.	Terms used	115
88.	Unauthorised structures, CEO may direct removal of	116
89.	Service of r. 88 notice	116
90.	Non-compliance with r. 88 notice	117
91.	Site of unauthorised structure to be cleared completely	118
	<b>Division 6 — Share arrangements and dispute procedure</b>	
92.	Share arrangement to be subject of written agreement	118
93.	Disputes over use of shared buildings etc., resolution procedure for	119
94.	Independent arbitrators, duties of	119
95.	Arbitrator's determination to be decided by Minister	120
	<b>Division 7 — Disposal of waste</b>	
96.	Waste disposal to be in accordance with this Division	120
97.	Food waste	120
98.	Paper, plastic, cardboard, bait bags etc.	121
99.	Non-hazardous and non-combustible waste	121
100.	Oil, fuel, engine filters and batteries	122
101.	Campsite waste	122
102.	Sewage	122
103.	Incinerators, construction and use of	123
	<b>Division 8 — Miscellaneous</b>	
104.	Noise to be kept below certain levels	123
105.	Vehicles not to be used without CEO's approval	124
106.	Domestic pets prohibited on reserve and boats at jetties	125
107.	Flora and fauna not to be introduced without approval	125
108.	Noxious etc. plants, pests etc., control of to be by approved methods	125

109.	Behaviour standards for people; power to direct person to leave	126
110.	Chlorine tarping of boats, restrictions on	126
112.	Weapons prohibited	127
113.	Open fires prohibited	127

**Part 9A — Fish Habitat Protection Areas**

**Division 1A — Abrolhos Islands Fish Habitat Protection Area**

113AA.	Notice of travel to Abrolhos Islands Fish Habitat Protection Area	128
113AB.	Notice of stay in Abrolhos Islands Fish Habitat Protection Area	128

**Division 1 — Cottesloe Reef Fish Habitat Protection Area**

113A.	Prohibited activities	129
-------	-----------------------	-----

**Division 2 — Lancelin Island Lagoon Fish Habitat Protection Area**

113B.	Prohibited activities	130
-------	-----------------------	-----

**Division 3 — Kalbarri Blue Holes Fish Habitat Protection Area**

113C.	Prohibited activities	130
-------	-----------------------	-----

**Division 4 — Point Quobba Fish Habitat Protection Area**

113D.	Terms used	131
113E.	Prohibited activities	131

**Part 10 — Register**

114.	Hours, place and fees prescribed (Act s. 124)	133
115.	Details prescribed (Act s. 126(e))	133
116.	Details of security interest prescribed (Act s. 128(2)(c))	134

**Part 11 — Authorisations**

**Division 1 — Commercial fishing**

117.	Fishing boats, duties of masters etc. as to licences, LFB numbers etc.	135
118.	Fishing boat licences, grant of	136

118A.	Fishing boat licence of no effect in some circumstances	137
119.	Carrier boats, duties of masters etc. as to licences, LCB numbers etc.	138
120.	Carrier boat licences, grant of	139
121.	Commercial fishing licence, when required	140
122.	Commercial fishing licences, grant of	140
123A.	Commercial fishing licence receipt may have effect as commercial fishing licence	140
<b>Division 2 — Recreational fishing</b>		
<b>Subdivision 1 — Recreational fishing licence</b>		
123.	Recreational fishing licence, when required	141
124.	Recreational fishing licences, grant of	142
124A.	Recreational fishing licence receipt may have effect as a recreational fishing licence	143
<b>Subdivision 2 — Recreational (boat) fishing licence</b>		
124B.	Recreational (boat) fishing licence, when required	144
124C.	Recreational (boat) fishing licences, grant of	146
124D.	Recreational (boat) fishing licence receipt may have effect as a recreational (boat) fishing licence	146
<b>Division 3 — Specific fish or specific methods of fishing</b>		
125.	Rock lobster pot licence, when required	147
126.	Rock lobster pot licence, grant of	148
<b>Division 5 — Fishing tour operators</b>		
128IA.	Term used: boat	148
128I.	Requirements for person conducting fishing tour using boat	148
128J.	Fishing tour operator's licence, grant of	149
128K.	Master of fishing boat used for fishing tours to notify Department of commercial fishing trip	151
128L.	Documents to be carried on boat etc. connected with fishing tour	151
128MA.	Boats used in connection with fishing tour	152
128M.	Operators etc. to ensure participants in fishing tour comply with recreational fishing laws	152
128OA.	Shark tourism activities prohibited on fishing tour	153
128O.	Sale of fish taken on fishing tour prohibited	153

128P.	Boat not to be used for both commercial fishing and fishing tour during single trip	154
128R.	Person in charge of restricted fishing tour not to permit rod on boat	154
128S.	Restricted fishing tours, limits on fishing etc. by participants etc.	154
<b>Division 6A — Replacement of cancelled authorisations</b>		
129A.	Terms used	155
129B.	CEO may grant certain replacement authorisations	156
<b>Division 6 — General</b>		
129.	Lost etc. authorisations, replacement of	157
130.	Conditions of licences, imposition of etc.	157
131.	Grounds for refusal of transfer of authorisations etc. prescribed (Act s. 140(2)(b))	158
132.	Short term use of boat instead of lost etc. licensed fishing boat etc., authorisation of	159
133.	Duration of licences	160
134.	Renewal of licences	161
135.	Application fees	161
136.	Recreational fishing licence fee halved for pensioners etc.	161
137.	Fees for grant or renewal of authorisation	162
138.	Transfer of part of entitlement not permitted in some cases	164
139.	Change of name or address, duty to notify CEO	164
<b>Part 12 — Fish trafficking</b>		
140.	Priority fish	165
141.	Commercial quantity	165
<b>Part 13A — Control of disease in pearl oysters</b>		
144A.	Terms used	167
144B.	Transport of pearl oysters into the State	168
144C.	Spat samples to be taken, preserved etc.	169
144D.	Transport of pearl oysters restricted	170
144E.	Sampling for disease testing	171
144F.	Certificates of health for pearl oysters	172
144G.	Approval for transport of pearl oysters	174

144H.	Consequences if certificate of health not issued	174
144I.	Pathologist to notify inspector as to certificate of health	175
144J.	CEO to notify approval to transport	176
144K.	Consequences of more than one batch of spat at quarantine site	176
144L.	Removal of spat from quarantine site	177
<b>Part 13B — Control of disease in abalone</b>		
144M.	Restriction on moving live abalone into the State	178
<b>Part 13 — Miscellaneous offences</b>		
144.	Certain activities in bays etc. and as to use of traps prohibited	179
145.	Explosives or noxious substances, carriage of on boats	179
146.	Explosive or noxious substance used to take fish, presumptions as to possession of	179
147A.	Arranging for transport by courier business of fish taken recreationally	180
147B.	Installation of fish aggregating device without approval of CEO	180
<b>Part 14 — Fisheries officers</b>		
147.	Warrant form prescribed (Act s. 187)	181
148.	Ways of disposing of fish prescribed (Act s. 194)	181
149.	Accounts prescribed (Act s. 194)	181
150.	Applying for compensation (Act s. 197(3))	182
<b>Part 15 — Legal proceedings</b>		
151.	Method for determining size etc. of fish prescribed (Act s. 214)	183
152.	Australian datum prescribed (Act s. 216)	183
153.	Way of giving notice prescribed (Act s. 219(1))	184
154.	Things forfeited to Crown, disposal of	184
155.	Accounts prescribed (Act s. 221(2))	185
156.	Provisions of regulations prescribed (Act s. 222(1))	185
157.	Values prescribed (Act s. 222(4)(a), (b))	186
158.	Offences prescribed (Act s. 224(1)(a))	186

159.	Offences prescribed (Act s. 228(1))	187
160.	Infringement notice form prescribed (Act s. 229(1))	187
161.	Withdrawal of infringement notice form prescribed (Act s. 231(1))	187
162.	Modified penalties prescribed (Act s. 229(2))	187
<b>Part 16 — Financial provisions</b>		
163.	Times prescribed for special purpose audits (Act s. 240)	189
<b>Part 17 — Miscellaneous</b>		
<b>Division 1 — Guidelines</b>		
164.	Ways of publishing guidelines prescribed (Act s. 246 and 247)	190
165.	Form of notice to attend inquiry etc. (Act s. 249(3))	190
<b>Division 2 — Exclusive licences</b>		
166.	Applications for exclusive licences	190
167.	Effect of exclusive licences	191
168.	Form of exclusive licences	191
169.	Renewal after expiry of exclusive licences (Act s. 139)	191
170.	Some draft exclusive licences to go before Parliament	191
171.	Conditions of exclusive licences	192
172.	Who can fish in areas the subject of exclusive licences	192
<b>Division 3 — Prohibition of activities that pollute waters</b>		
173.	Notice prohibiting activities, form of (Act s. 255(1))	193
174.	Notice of variation or revocation, form of (Act s. 255(2)(c))	193
<b>Division 4 — General</b>		
176.	Non-endemic fish, approval to import into WA etc.	193
177.	Disease control at fish processing or aquaculture places	194
178.	Fish for scientific purposes, authority to fish for	195
179.	Fish for genetic etc. analysis, approval to take etc.	196
180.	Categories of fish (Sch. 4)	197

Contents

---

181A.	Certain things are not personal property for purposes of <i>Personal Property Securities Act 2009</i> (Cwlth)	197
181.	Fees and charges, reduction and waiver of	198
<b>Part 18 — Savings and transitional provisions</b>		
182.	Limited entry fisheries under repealed Act (Act s. 74)	199
183.	Citation of notices	199
186.	Certain notices under repealed Act continued as orders (Act s. 43)	200
<b>Schedule 1 — Fees</b>		
<b>Part 1 — General fees</b>		
<b>Part 2 — Application fees</b>		
<b>Part 3 — Fees for the grant or renewal of authorisations</b>		
<b>Schedule 2 — Protected fish</b>		
<b>Part 1 — Commercially protected fish</b>		
<b>Part 2 — Totally protected fish</b>		
<b>Division 1 — Certain reproducing crustaceans</b>		
<b>Division 2 — Miscellaneous</b>		
<b>Division 3 — Marine or fluvio-marine fish</b>		
<b>Subdivision 1 — Protected by reference to species, area and period</b>		
1.	Pink Snapper	216
2.	Baldchin Groper	217
3.	Cobbler	217
4.	Blue Groper	217



**Subdivision 2 — Protected by reference to species length or other factors**

**Division 4 — Freshwater fish**

**Division 5 — Crustaceans, other than those listed in Division 1**

**Division 6 — Molluscs**

**Part 3 — Recreationally protected fish**

**Schedule 3**

**Bag limits**

**Part 1 — Bag limits — demersal finfish**

**Division 1 — Regions other than West Coast region**

**Division 2 — West Coast region**

**Part 2 — Bag limits — large pelagic fish**

**Part 3 — Bag limits — nearshore or estuarine finfish**

**Part 4 — Bag limits — freshwater finfish**

**Part 5 — Bag limits — crustaceans**

**Part 6 — Bag limits — molluscs and other invertebrates**

**Schedule 4 — Categories of fish**

**Schedule 5 — Noxious fish**

**Schedule 6**

**Area of land prescribed under  
section 91(d) of the Act**

**Schedule 7**

**List of common and scientific names**

**Division 1 — Marine or fluvio-marine fish**

**Division 2 — Freshwater fish**

**Division 3 — Crustaceans**

**Division 4 — Molluscs**

**Division 5 — Other**

**Schedule 8**

**Determination of characteristics of  
fish**

**Part 1 — Length**

**Part 2 — Method of determining the  
volume of fish**

**Part 3 — Method of determining the  
length of fish trunks and fillets**

**Schedule 9 — Determining the value  
of fish**

**Schedule 10**

**Non-endemic species of fish permitted  
to be brought into the State**

**Part 1 — Species of fish endemic to  
areas of Australia outside the  
State**

**Part 2 — Species of fish not endemic  
to Australia**

	<b>Schedule 11</b>	
	<b>Authorised trade names of fish</b>	
	<b>Schedule 12</b>	
	<b>Modified penalties</b>	
	<b>Schedule 13</b>	
	<b>Specifications for rock lobster pots</b>	
	<b>Part 1A — Preliminary</b>	
1A.	Term used: relevant minimum gap	285
	<b>Part 1 — Waters north of 21° 44' south latitude</b>	
1.	Entrance or neck of pot	285
	<b>Part 2 — Waters between 21° 44' south latitude and 34° 24' south latitude (excluding some waters off the South Coast)</b>	
2.	Entrance or neck of pot	285
3.	Beehive pots	286
4.	Batten pots	287
5.	Other pots	290
7.	All pots	291
	<b>Part 3 — All other waters</b>	
8.	Entrance or neck of pot	291
9.	Beehive pots	292
10.	Batten pots	292
11.	Other pots	293
13.	All pots	294

**Schedule 14**

**Forms**

**Schedule 15 — Tour management zones**

1.	Zone 1: Pilbara/Kimberley	314
2.	Zone 2: Gascoyne	314
3.	Zone 3: West Coast	314
4.	Zone 4: South Coast	314

**Schedule 16 — Abalone zones**

1.	Abalone Zone 1: Busselton Jetty to Greenough River mouth	315
2.	Abalone Zone 2: Greenough River mouth to Northern Territory border	315
3.	Abalone Zone 3: Busselton Jetty to South Australian border	316

**Schedule 17 — Fish diseases**

**Division 1 — Diseases of crustaceans**

**Division 2 — Diseases of molluscs**

**Division 3 — Diseases of other fish**

**Schedule 18 — Diseases of pearl oysters**

**Notes**

Compilation table	321
-------------------	-----

**Defined terms**

## Fish Resources Management Regulations 1995

### Part 1 — Preliminary

**1. Citation**

These regulations may be cited as the *Fish Resources Management Regulations 1995*<sup>1</sup>.

**2. Commencement**

These regulations come into operation on the day on which the *Fish Resources Management Act 1994* comes into operation<sup>1</sup>.

**3. Terms used**

- (1) In these regulations, unless the contrary intention appears —  
*Abalone Zone*, followed by a number, means the zone of that number described in Schedule 16;

*Abrolhos Islands Fish Habitat Protection Area* means the area of WA waters adjacent to the Abrolhos Islands from the high water mark to the seaward limits of the coastal waters of the State;

*aircraft* includes a float plane and an air cushioned craft;

*bag limit* has the same meaning as in section 50 of the Act;

*carrier boat licence* means a licence referred to in regulation 119;

*commercial fishing licence* means a licence referred to in regulation 121;

**complying drop net** means a drop net that —

- (a) is not more than 1.5 m at its widest point; and
- (b) is so constructed that when set —
  - (i) its side or sides collapse so that its netting lies flat on the ground; and
  - (ii) its netting is not capable of ensnaring or entangling a fish;

**Cottesloe Reef waters** means the waters of the Cottesloe Reef as defined in the *Cottesloe Reef Fish Habitat Protection Area Order 2001*;

**disease** means any disease of fish;

**eastern gulf land area** means the land adjacent to the waters of the Shark Bay eastern gulf;

**fillet** means any part or piece of a finfish, other than a whole fish, fish trunk, head, tail, fin or a product of gilling or gutting the fish;

**finfish** means fish of the Class Elasmobranchii (Chondrichthyes) or Osteichthyes;

**fish processor's licence** means a licence granted under section 83 of the Act;

**fish trunk** means —

- (a) a finfish that would be a whole fish except that —
  - (i) all of its head; and
  - (ii) all of its tail,has been removed; or
- (b) a finfish described in regulation 14(4) that would be a whole fish except that all, or any part of, its head, tail or scales has been removed; or
- (c) a shark that would be a whole fish except that —
  - (i) all of its head; and
  - (ii) all of its tail; and

- (iii) one or more of its fins,  
has been removed;

***fishing boat licence*** means a licence referred to in regulation 117;

***fishing net*** means any fishing net other than —

- (a) a hand scoop or hand dip net; or
- (b) a prawn hand trawl net; or
- (c) a complying drop net;

***form*** followed by a number means the form of that number in Schedule 14;

***Freycinet Estuary*** means the waters of the Shark Bay western gulf south of 26° 13' south latitude, excluding the waters of Useless Inlet and Blind Inlet;

***Gascoyne Region*** means —

- (a) all land in the State; and
- (b) all WA waters,

that are north of 27° 00' south latitude, excluding the Pilbara and Kimberley Region;

***gear identification number*** of a person means —

- (a) any letters and numbers specified in accordance with —
  - (i) regulation 124(2)(b) on a recreational fishing licence held by the person; or
  - (ii) regulation 124A(4) on a receipt, within the meaning of that regulation, for an application for a recreational fishing licence issued to the person;

or

- (b) where the person is an Aboriginal person who does not hold a recreational fishing licence, the letter “A” followed by the day, month and year of the birth of the person in numbers (i.e. A 29/3/59);

**r. 3**

---

**jet ski** means a jet ski or any other any vessel designed for the transport of one, 2 or 3 persons that —

- (a) is propelled by means of an inboard motor powering a water jet pump; and
- (b) is designed to be steered by means of handlebars by a person sitting, standing or kneeling on the vessel and not within it;

**Kalbarri Blue Holes waters** means the waters of the Kalbarri Blue Holes as defined in the *Kalbarri Blue Holes Fish Habitat Protection Area Order 2007*;

**Lancelin Island Lagoon** means the waters of the Lancelin Island Lagoon as defined by the *Lancelin Island Lagoon Fish Habitat Protection Area Order 2001*;

**licensed carrier boat** means a boat in respect of which a carrier boat licence is held;

**licensed carrier boat number** in respect of a licensed carrier boat means the number allocated under regulation 120(3) in respect of the boat;

**licensed fishing boat** means a boat in respect of which a fishing boat licence is held;

**licensed fishing boat number** in respect of a licensed fishing boat means the letter and number allocated under regulation 118(3) in respect of the boat;

**marron drop net** has the same meaning as in regulation 38G;

**marron pole snare** has the same meaning as in regulation 38G;

**marron scoop net** has the same meaning as in regulation 38G;

**marron trophy waters** means the waters of —

- (a) Harvey Weir; and
- (b) Lake Navarino (Waroona Dam) and its tributaries; and
- (c) Hutt River;

**metropolitan waters** means all WA waters between 31° 29.580' south latitude (northern wall of the Two Rocks Marina) and 32° 41.453' south latitude (Cape Bouvard);



**mollusc** does not include pearl oyster;

**motor boat** means a vessel propelled otherwise than by oars or sail and includes a personal watercraft within the meaning of the *Navigable Waters Regulations 1958*;

**Ningaloo Marine Park** means all waters reserved under section 13 of the *Conservation and Land Management Act 1984* as Class “A” Marine Park Reserve No. 2, Ningaloo Marine Park;

**one day** means a period of 24 hours commencing at midnight, other than in relation to fishing for marron or prawns or fishing by means of a fishing net, where it means a period of 24 hours commencing at midday;

**Pilbara and Kimberley Region** means —

- (a) all land in the State; and
- (b) all WA waters,

that are east of 114° 50' east longitude and north of 21° 46' south latitude;

**prawn hand trawl net** means a net —

- (a) of not more than 4 m in length; and
- (b) with a mesh of not less than 16 mm;

**principal place of residence** in respect of a person, does not include —

- (a) a tent, vehicle or boat; or
- (b) a caravan, within the meaning of the *Caravan Parks and Camping Grounds Act 1995*, unless the caravan is the person's principal place of residence; or
- (c) premises where fish are processed or stored for a commercial purpose; or
- (d) premises where fish are sold or purchased;

**pull** in relation to a rock lobster pot, means to bring the pot from the seabed to the surface of the sea;

r. 3

---

**recreational fishing licence** means a licence referred to in regulation 123;

**region** means any of the following areas of the State —

- (a) the Gascoyne Region;
- (b) the Pilbara and Kimberley Region;
- (c) the South Coast Region;
- (d) the West Coast Region;

**rock lobster pot** means any fishing gear, other than a hand held instrument, that is capable of being used to fish for rock lobster;

**rock lobster pot licence** means a licence referred to in regulation 125;

**rock lobster tail** means the whole or part of the abdomen of a rock lobster at any time after that abdomen or part of that abdomen has been severed from the carapace;

**scheduled fish disease** means a disease mentioned in Schedule 17;

**set** in respect of a net or any other fishing gear, means to fix the net or fishing gear in place so that it remains stationary;

**single-sided fillet** means a fillet that is taken from one side only of a fish;

**South Coast Region** means —

- (a) all WA waters off the southern coast of WA east of 115° 30' east longitude; and
- (b) all land and all WA waters east of 115° 30' east longitude and in any of the following local government districts designated under the *Local Government Act 1995* —
  - (i) the Cities of Albany and Kalgoorlie-Boulder; and
  - (ii) the Shires of Boyup Brook, Bridgetown-Greenbushes, Broomehill, Coolgardie, Cranbrook, Denmark, Dumbleyung, Dundas, Esperance, Gnowangerup, Jerramungup,

Katanning, Kent, Kojonup, Kondinin, Kulin, Lake Grace, Manjimup, Nannup, Plantagenet, Ravensthorpe, Tambellup and Woodanilling;

*sunrise* and *sunset* mean the times provided by the Perth Astronomical Observatory for sunrise and sunset on the relevant day;

*waters of the Shark Bay eastern gulf* means the waters south and east of a line commencing at the high water mark of the northernmost point of Cape Peron, from there due north to the intersection with a line drawn due east from the high water mark of the southernmost point of Cape St Cricq, and from there due east to the mainland, but not including the waters of Denham Sound nor the Freycinet Estuary;

*waters of the Shark Bay western gulf* means the waters bounded by a line commencing at the high water mark at the intersection of 25° 35.125' south latitude and 113° 01.227' east longitude (Withnell Point); thence extending east along the parallel to the intersection with 113° 15' east longitude; thence north along the meridian to the intersection of 25° 30.200' south latitude; thence east along the parallel to the high water mark of Cape Peron at the intersection of 25° 30.200' south latitude and 113° 30.600' east longitude; thence generally in a southerly direction along the high water mark on the western side of Peron Peninsula; thence continuing westerly then northerly along the high water mark on the eastern side of Edel Land Peninsula; thence following the high water mark around Heirisson Prong and Bellefin Prong to the intersection of the high water mark and 113° 12.9' east longitude; thence along the geodesic to the intersection of 113° 12.9' east longitude and the high water mark (southern end) of Dirk Hartog Island; thence generally northerly along the high water mark on the eastern side of Dirk Hartog Island to the commencement point;

*West Coast Region* means —

- (a) all land in the State; and
- (b) all WA waters,

r. 4

---

that are south of 27° 00' south latitude, excluding the South Coast Region;

**western gulf land area** means the land adjacent to the waters of the Shark Bay western gulf;

**whole fish** means a finfish that is —

- (a) entire; or
- (b) entire except that it has been gilled or gutted, or both.

- (2) Where in these regulations fish is referred to by only a common name set out in column 1 of Schedule 7 the fish referred to is the fish described by the scientific classification set out in column 2 of that Schedule opposite that common name.

*[Regulation 3 amended in Gazette 29 Jun 2001 p. 3163; 28 Feb 2003 p. 660-1; 7 Mar 2003 p. 743-4; 1 Oct 2003 p. 4281-4; 28 Nov 2003 p. 4775; 23 Dec 2003 p. 5204-5; 6 Apr 2004 p. 1132; 3 Jun 2005 p. 2490; 4 Nov 2005 p. 5300-1; 29 Dec 2006 p. 5889; 4 Sep 2007 p. 4519; 21 Dec 2007 p. 6326; 6 Nov 2009 p. 4470-1; 29 Jan 2013 p. 301; 28 Jun 2013 p. 2888; 24 Sep 2013 p. 4437; 30 May 2014 p. 1714; 22 Oct 2014 p. 4087.]*

[3A. Deleted in Gazette 4 Nov 2005 p. 5301.]

**4. Body prescribed (Act s. 4(1) *peak industry body*)**

The Western Australian Fishing Industry Council (Inc.) is the body prescribed for the purposes of the definition of ***peak industry body*** in section 4(1) of the Act.

**5. Classes of fish prescribed (Act s. 4(1) *process*)**

Rock lobster and marron are fish of a prescribed class for the purpose of the definition of ***process*** in section 4(1) of the Act.

**6. Fee prescribed for exemption application (Act s. 7(4))**

The fee that is to accompany an application for an exemption under section 7(4) of the Act is as set out in item 1 of Part 1 of Schedule 1.

**7. Exemption, power to require return of**

- (1) The CEO may, by notice in writing given to the holder of an exemption, require the person to return the exemption to the CEO within a period specified in the notice if —
- (a) the exemption has expired or has been revoked; or
  - (b) the Minister or the CEO has exercised a power under section 7(6)(b) of the Act to delete, vary or add to any conditions imposed in relation to the exemption.
- (2) A person must not, without reasonable excuse, refuse or fail to comply with a requirement made under subregulation (1).

Penalty: In the case of an individual, \$5 000 or, in the case of a body corporate, \$10 000.

*[Regulation 7 amended in Gazette 6 Jul 2007 p. 3389.]*

## **Part 2 — Administration**

### **8. Common seal of Minister for Fisheries, use of etc.**

The common seal of the Minister for Fisheries is to be kept in safe custody by the CEO, and is not to be affixed to any document except by the Minister in the presence of the CEO, or a person appointed by the CEO for that purpose, who is to —

- (a) sign their name as witness to the affixing of the seal; and
- (b) print on the document their name and the date on which, and the place where, the seal was affixed to the document.

*[Regulation 8 amended in Gazette 6 Jul 2007 p. 3389.]*

### **Part 3 — Advisory committees**

**9. Procedure for appointments prescribed (Act s. 29(2), 33(2) and 37(2))**

The prescribed procedure in respect of the appointment of persons by the Minister for the purposes of sections 29(2)(c), 33(2)(b) and 37(2)(b) of the Act is that the Minister is to —

- (a) arrange for there to be published in a newspaper circulating daily in the State a notice to the effect that a person is, or persons are, required under the relevant section of the Act and that interested persons may, within the time specified in the notice, apply to the Minister with details of relevant qualifications and experience for appointment under the relevant section of the Act; and
- (b) after the expiry of the time specified in the notice, consider all of the applications and the qualifications and experience of each applicant and of such other persons as the Minister thinks fit; and
- (c) appoint the required number of persons in accordance with the relevant section of the Act.

## **Part 4 — General regulation of fishing**

### **Division 1 — Protected fish**

#### **10. Classes of fish prescribed (Act s. 45)**

For the purposes of the Act —

- (a) the classes of fish listed in Schedule 2 Part 1 are commercially protected fish; and
- (b) the classes of fish listed in Schedule 2 Part 2 are totally protected fish; and
- (c) the classes of fish listed in Schedule 2 Part 3 are recreationally protected fish.

*[Regulation 10 inserted in Gazette 14 Sep 2012 p. 4372-3.]*

#### **11. Defences etc. prescribed (Act s. 48)**

- (1) For the purposes of section 48(1)(b) of the Act all fish the subject of an aquaculture licence are fish of a prescribed class.
- (2) For the purposes of section 48(1)(c) of the Act it is a defence that the fish was taken by a person acting under an authority to fish for fish for scientific purposes issued under regulation 178.
- (3) For the purposes of section 48(1)(c) of the Act it is a defence that the person is a person to whom, or in relation to whom, section 90 of the Act does not apply due to the operation of section 91 of the Act.
- (4) For the purposes of section 48(1)(c) of the Act, where the fish the subject of an offence —
  - (a) is a shark or ray that is commercially protected; and
  - (b) in the case of a dusky shark, has an interdorsal fin length, within the meaning in Schedule 2 Part 2 Division 2, of less than 70 cm,

it is a defence that the fish was taken by a person acting under a managed fishery licence granted in respect of —

- (c) the Marine Aquarium Fish Managed Fishery; or



- (d) the Kimberley Gillnet and Barramundi Managed Fishery; or
  - (e) any other managed fishery the management plan for which specifically allows for the taking of sharks or rays; or
  - (f) if the fish is an Eagle Ray, the South Coast Estuarine Managed Fishery.
- (5) For the purposes of section 48(1)(c) of the Act, where the fish the subject of an offence is a totally protected whaler shark other than a dusky shark, it is a defence that the fish was taken by a person acting under a managed fishery licence granted in respect of a managed fishery the management plan for which specifically allows for the taking of sharks or rays.
- (6) For the purposes of section 48(1)(c) of the Act, where the fish the subject of an offence is a weedy seadragon, it is a defence that the fish was taken by a person acting under a managed fishery licence granted in respect of the Marine Aquarium Fish Managed Fishery.

*[Regulation 11 inserted in Gazette 10 Nov 2006 p. 4704-5; amended in Gazette 13 Feb 2009 p. 298; 2 Nov 2011 p. 4620.]*

**12. Totally protected rock lobsters and crabs to be released**

- (1) Any person who takes from the sea any totally protected fish that is a rock lobster must ensure that the rock lobster is —
- (a) released to the sea within 5 minutes of being taken; and
  - (b) if taken by means of a rock lobster pot, is released to the sea before any other rock lobster pot is pulled.
- (2) The master of a boat must ensure that any totally protected fish that is a rock lobster taken from the sea and brought on board the boat —
- (a) is released to the sea within 5 minutes of being taken; and
  - (b) if taken by means of a rock lobster pot, is released to the sea before any other rock lobster pot is pulled.

- (3) Any person, other than the holder of a commercial fishing licence, who takes any totally protected fish that is a crab must —
- (a) ensure that the crab is released to the waters from which it was taken within 5 minutes of being taken; and
  - (b) not pull any drop net before the crab is released to the waters from which it was taken.

Penalty: In the case of an individual, \$3 000 or, in the case of a body corporate, \$6 000.

**13. Mutilated etc. protected fish, possession of**

A person must not, without reasonable excuse, be in possession of, or sell, any fish which has been altered, mutilated or disfigured so that it is not possible to readily identify whether or not the fish is a protected fish.

Penalty: In the case of an individual, \$5 000 or, in the case of a body corporate, \$10 000.

**Division 2 — Requirements regarding fish trunks and fillets**

*[Heading inserted in Gazette 4 Nov 2005 p. 5301.]*

**14A. Term used: specified size**

In this Division —

*specified size*, in relation to a class of finfish, means the size specified in the first Table in Schedule 2 Part 2 Division 3 Subdivision 2 for that class of finfish.

*[Regulation 14A inserted in Gazette 29 Jan 2013 p. 302.]*

**14. Certain types of finfish, how to be landed**

- (1) A person must not —
- (a) bring a finfish referred to in an item in the Table onto land from waters specified for that item; or

- (b) carry a finfish referred to in an item in the Table through waters specified for that item,  
unless it is a whole fish.

**Table**

<b>Item</b>	<b>Type of finfish</b>	<b>Waters</b>
1.	barramundi	WA waters
2.	estuary cod	WA waters
3.	malabar cod	WA waters
4.	pink snapper	the waters of the Shark Bay western gulf and the waters of the Shark Bay eastern gulf

Penalty: a fine of \$3 000 and the penalty provided in section 222 of the Act.

- (2) Subregulation (1) does not apply to, or in respect of —
- (a) finfish taken for a commercial purpose in accordance with an authorisation; or
  - (b) whaler shark that is a fish trunk; or
  - (c) finfish on a boat if the finfish is —
    - (i) being consumed; or
    - (ii) prepared, or being prepared, for immediate consumption by persons on the boat.
- (3) A person must not bring onto land or carry through WA waters a finfish of a class referred to in the first Table in Schedule 2 Part 2 Division 3 Subdivision 2 that is equal to or greater than the specified size for the class of fish unless it is —
- (a) a whole fish; or
  - (b) a fish trunk or fillet that —
    - (i) has the skin and scales attached; and
    - (ii) is at least 300 mm in length; and

**Fish Resources Management Regulations 1995**

**Part 4** General regulation of fishing

**Division 2** Requirements regarding fish trunks and fillets

**r. 16B**

---

- (iii) is packaged flat; and
- (iv) is packaged so that it is easily accessible for measurement and identification; and
- (v) where the fish is frozen, can be measured and identified without being thawed.

Penalty: a fine of \$3 000 and the penalty provided in section 222 of the Act.

- (4) A person must not bring onto land or carry through WA waters a finfish other than a finfish referred to in subregulation (1) or (3) unless it is —
  - (a) a whole fish; or
  - (b) a fish trunk or fillet that has the skin attached.

Penalty: a fine of \$1 000 and the penalty provided in section 222 of the Act.

- (5) Subregulations (3) and (4) do not apply to, or in respect of —
  - (a) finfish taken for a commercial purpose in accordance with an authorisation; or
  - (b) finfish on a boat if the finfish is —
    - (i) being consumed; or
    - (ii) prepared, or being prepared, for immediate consumption by persons on the boat.

*[Regulation 14 inserted in Gazette 29 Jan 2013 p. 302-3; amended in Gazette 28 Jun 2013 p. 2888-90; 30 May 2014 p. 1714.]*

*[15, 16. Deleted in Gazette 28 Jun 2013 p. 2890.]*

*[16A. Deleted in Gazette 29 Jan 2013 p. 302.]*

**16B. Sharks and rays, possession of by commercial fishers**

- (1) A master of a fishing boat must not have on the boat any shark or ray other than a whole shark or ray.

Penalty: \$10 000 and the penalty provided in section 222 of the Act.

- (2) Subregulation (1) does not prevent the master of a fishing boat from having on the boat a shark or ray that is not a whole shark or ray if —
- (a) all of the parts of the shark or ray (other than disposable parts) are on the boat together; and
  - (b) either —
    - (i) the only parts (other than disposable parts) that have been removed from the shark or ray are one or more of the fins; or
    - (ii) both —
      - (I) the boat is north of 26° south latitude; and
      - (II) the fish is not a dusky shark.
- (3) A person must not bring onto land any shark or ray taken for a commercial purpose in accordance with an authorisation other than a whole shark or ray.

Penalty: \$10 000 and the penalty provided in section 222 of the Act.

- (4) Subregulation (3) does not prevent a person bringing onto land a shark or ray that is not a whole shark or ray if —
- (a) all of the parts of the shark or ray (other than the disposable parts) are brought onto land together; and
  - (b) either —
    - (i) the only parts (other than disposable parts) that have been removed from the shark or ray are one or more of the fins; or
    - (ii) both —
      - (I) the place where the fish is brought onto land is north of 26° south latitude; and
      - (II) the fish is not a dusky shark.

(5) In this regulation —

**disposable part** means any of the following —

- (a) the head;
- (b) the tail;
- (c) the parts removed during gutting;

**whole shark or ray** means a shark or ray that is —

- (a) entire; or
- (b) entire except that any or all of the disposable parts have been removed.

[Regulation 16B inserted in Gazette 10 Nov 2006 p. 4705-6.]

### **Division 3 — Possession limits**

[Heading inserted in Gazette 1 Oct 2003 p. 4289.]

#### **Subdivision 1A — Preliminary**

[Heading inserted in Gazette 4 Nov 2005 p. 5306.]

#### **16C. Term used: finfish**

In this Division —

**finfish** does not include fish of the Family Atherinidae, Clupeidae, Engraulidae, Hemirhamphidae or Mugilidae.

[Regulation 16C inserted in Gazette 4 Nov 2005 p. 5306; amended in Gazette 22 Dec 2005 p. 6218.]

#### **16CA. Bag limits, application and effect of**

- (1) The bag limit that applies in respect of fish that a person is in possession of is the bag limit that applies in any region or other area of the State in which the person is in possession of any fish which would permit the person to be in possession of the greatest number of fish.
- (2) Despite subregulation (1), the maximum quantity of fish that a person may be in possession of must not exceed the bag limit

that applies in respect of the fish in the region or other area of the State where the fish is, or are, located.

*[Regulation 16CA inserted in Gazette 4 Nov 2005 p. 5306.]*

**Subdivision 1 — Possession limits Statewide**

*[Heading inserted in Gazette 1 Oct 2003 p. 4289.]*

**16D. Finfish, general possession limit of (Act s. 51(1))**

- (1) For the purposes of section 51(1) of the Act, the maximum quantity of finfish that a person may be in possession of in circumstances other than those to which regulation 16E(2) or (3) applies is —
  - (a) 20 kg of fillets of fish; or
  - (b) 10 kg of fillets of fish and one day's bag limit of whole fish or fish trunks; or
  - (c) 2 days' bag limit of whole fish or fish trunks.
- (2) This regulation is subject to regulations 16H, 16I, 16J and 16M.

*[Regulation 16D inserted in Gazette 1 Oct 2003 p. 4289-90; amended in Gazette 4 Nov 2005 p. 5306; 29 May 2008 p. 2055-6.]*

**16E. Fish on boats (Act s. 51(1))**

- (1) In this regulation —

***charter boat*** means a boat that is used to conduct a fishing tour for a commercial purpose in accordance with a fishing tour operator's licence or a restricted fishing tour operator's licence;

***day trip*** means a voyage undertaken by a person on a boat, except a voyage which has taken place over more than one day;

***single-sided fillet*** means a fillet that is taken from one side only of a fish.

**Fish Resources Management Regulations 1995**

**Part 4** General regulation of fishing

**Division 3** Possession limits

**r. 16E**

---

- (2) For the purposes of section 51(1) of the Act, the maximum quantity of finfish that a person on a boat may be in possession of where the person is on, or has just completed, a day trip is —
- (a) where all of the fish is filleted, 20 kg of fillets of fish; or
  - (b) where not all of the fish is filleted, one day's bag limit of whole fish or fish trunk, not more than 10 kg of which is filleted.
- (3) For the purposes of section 51(1) of the Act, the maximum quantity of finfish that the master of a boat may be in possession of on the boat where the master is on, or has just completed, a day trip is —
- (a) where all of the fish is filleted, 20 kg of fillets of fish; or
  - (b) where not all of the fish is filleted, one day's bag limit of whole fish or fish trunks, not more than 10 kg of which is filleted.
- (3A) For the purposes of section 51(1) of the Act, the maximum quantity of fish of the species referred to in this subregulation that a person on a boat may be in possession of, whether the fish is on or attached to the boat or any tender or other vessel operating with or attached to the boat, is —
- (a) if there is only one person on the boat —
    - (i) one day's bag limit of blue manna crabs; and
    - (ii) one day's bag limit of mud crabs (brown and green combined); and
    - (iii) one day's bag limit of cuttlefish, octopus and squid (combined); and
    - (iv) one day's bag limit of rock lobster; and
    - (v) one day's bag limit of brownlip and greenlip abalone (combined);
  - or
  - (b) if there are 2 persons on the boat —
    - (i) 2 days' bag limit of blue manna crabs; and
    - (ii) 2 days' bag limit of mud crabs (brown and green combined); and



- (iii) 2 days' bag limit of cuttlefish, octopus and squid (combined); and
- (iv) 2 days' bag limit of rock lobster; and
- (v) 2 days' bag limit of brownlip and greenlip abalone (combined);

or

- (c) if there are 3 or more persons on the boat —
  - (i) 2 days' bag limit of blue manna crabs; and
  - (ii) 2 days' bag limit of mud crabs (brown and green combined); and
  - (iii) 2 days' bag limit of cuttlefish, octopus and squid (combined); and
  - (iv) 3 days' bag limit of rock lobster; and
  - (v) 2 days' bag limit of brownlip and greenlip abalone (combined).

(3B) For the purposes of section 51(1) of the Act, the maximum quantity of fish of the species referred to in this subregulation that the master of a boat may be in possession of on the boat, whether the fish is on or attached to the boat or any tender or other vessel operating with or attached to the boat, is —

- (a) if there is only one person on the boat —
  - (i) one day's bag limit of blue manna crabs; and
  - (ii) one day's bag limit of mud crabs (brown and green combined); and
  - (iii) one day's bag limit of cuttlefish, octopus and squid (combined); and
  - (iv) one day's bag limit of rock lobster; and
  - (v) one day's bag limit of brownlip and greenlip abalone (combined);

or

- (b) if there are 2 persons on the boat —
  - (i) 2 days' bag limit of blue manna crabs; and

**Fish Resources Management Regulations 1995**

**Part 4** General regulation of fishing

**Division 3** Possession limits

**r. 16E**

---

- (ii) 2 days' bag limit of mud crabs (brown and green combined); and
  - (iii) 2 days' bag limit of cuttlefish, octopus and squid (combined); and
  - (iv) 2 days' bag limit of rock lobster; and
  - (v) 2 days' bag limit of brownlip and greenlip abalone (combined);
- or
- (c) if there are 3 or more persons on the boat —
    - (i) 2 days' bag limit of blue manna crabs; and
    - (ii) 2 days' bag limit of mud crabs (brown and green combined); and
    - (iii) 2 days' bag limit of cuttlefish, octopus and squid (combined); and
    - (iv) 3 days' bag limit of rock lobster; and
    - (v) 2 days' bag limit of brownlip and greenlip abalone (combined).
- (3C) Despite subregulations (3A) and (3B), the master of a boat that is not a fishing boat must ensure that the quantity of fish of the species referred to in this subregulation that is on or attached to the boat and any tender or other vessel operating with or attached to the boat is not more than —
- (a) if there is only one person on the boat —
    - (i) one day's bag limit of blue manna crabs; and
    - (ii) one day's bag limit of mud crabs (brown and green combined); and
    - (iii) one day's bag limit of cuttlefish, octopus and squid (combined); and
    - (iv) one day's bag limit of rock lobster; and
    - (v) one day's bag limit of brownlip and greenlip abalone (combined);

or

- (b) if there are 2 persons on the boat —
- (i) 2 days' bag limit of blue manna crabs; and
  - (ii) 2 days' bag limit of mud crabs (brown and green combined); and
  - (iii) 2 days' bag limit of cuttlefish, octopus and squid (combined); and
  - (iv) 2 days' bag limit of rock lobster; and
  - (v) 2 days' bag limit of brownlip and greenlip abalone (combined);

or

- (c) if there are 3 or more persons on the boat —
- (i) 2 days' bag limit of blue manna crabs; and
  - (ii) 2 days' bag limit of mud crabs (brown and green combined); and
  - (iii) 2 days' bag limit of cuttlefish, octopus and squid (combined); and
  - (iv) 3 days' bag limit of rock lobster; and
  - (v) 2 days' bag limit of brownlip and greenlip abalone (combined).

Penalty: a fine of \$10 000 and the penalty provided in section 222 of the Act.

(3D) Subregulations (3A)(a)(ii) and (b)(ii), (3B)(a)(ii) and (b)(ii) and (3C)(a)(ii) and (b)(ii) are subject to regulation 17A.

(3E) The master of a boat, other than a fishing boat, being used for taking fish in the West Coast Region must ensure that the number of West Australian dhufish on, or attached to, the boat, and any tender or other vessel operating with or attached to the boat, at any one time —

- (a) if the boat is a charter boat — is not more than 6; or
- (b) if the boat is other than a charter boat — is not more than 2.

Penalty: a fine of \$10 000 and the penalty provided in section 222 of the Act.

**Fish Resources Management Regulations 1995**

**Part 4** General regulation of fishing

**Division 3** Possession limits

**r. 16GA**

---

- (4) In any proceedings for an offence under section 51(2) of the Act in the circumstances referred to in subregulations (3a) or (3b) it is a defence for the person charged to prove that the person was the master of a commercial passenger boat not used for fishing.
- (5) For the purpose of —
- (a) subregulations (3) and (3b), fish on a boat that are not in the possession of any other person on the boat are to be taken to be in the possession of the master of the boat; and
  - (b) determining the number of fish in a person's possession under subregulation (2)(b) or (3)(b) 2 single-sided fillets of finfish are to be taken to be equivalent to one whole fish.

*[Regulation 16E inserted in Gazette 1 Oct 2003 p. 4290; amended in Gazette 4 Nov 2005 p. 5306-8; 11 Nov 2005 p. 5565-6; 22 Dec 2005 p. 6218-19; 19 Dec 2008 p. 5361-2; 8 Dec 2009 p. 4994; 1 Mar 2011 p. 668-70; 24 Feb 2012 p. 801-2; 25 Sep 2012 p. 4517-19; 28 Jun 2013 p. 2890.]*

**16GA. Rock lobster (Act s. 51(1))**

Subject to regulation 16E(3A)(a)(iv) and (b)(iv), (3B)(a)(iv) and (b)(iv) and (3C)(a)(iv) and (b)(iv), for the purposes of section 51(1) of the Act, the maximum quantity of rock lobster that a person may be in possession of is 24 rock lobsters.

*[Regulation 16GA inserted in Gazette 29 Jan 2013 p. 304.]*

**16GB. Barramundi (Act s. 51(1))**

- (1) For the purposes of section 51(1) of the Act, the maximum quantity of barramundi that a person may be in possession of, other than at the person's principal place of residence, is 2 barramundi.
- (2) For the purpose of determining the number of barramundi in a person's possession 2 single-sided fillets of barramundi are to be taken to be equivalent to one whole barramundi.

*[Regulation 16GB inserted in Gazette 29 Jan 2013 p. 304.]*

**16GC. Marron (Act s. 51(1), (2))**

- (1) For the purposes of section 51(1) of the Act, the maximum quantity of marron that a person may be in possession of —
  - (a) on marron trophy waters or within 500 m of the high water mark of marron trophy waters, is 5 marron; and
  - (b) at any other place, is 16 marron.
- (2) The possession limits prescribed by subregulation (1) do not apply during the non-possession period as defined in regulation 38O.
- (3) The possession limit prescribed by subregulation (1)(b) does not apply to a person who is on private land owned or occupied by the person.
- (4) It is a defence in proceedings against a person under section 51(2) of the Act in respect of the possession of marron —
  - (a) that the marron had been sold by retail to the public; or
  - (b) that the marron were in the person's possession at a place for the purpose of being —
    - (i) sold by retail to the public; or
    - (ii) served as meals to the public,in, on or from that place; or
  - (c) that the marron were in the person's possession —
    - (i) at a place specified in a fish processor's licence under section 83(2) of the Act; and
    - (ii) for the purpose of being processed in accordance with that licence.

*[Regulation 16GC inserted in Gazette 29 Jan 2013 p. 305.]*

**16GD. Abalone (Act s. 51(1))**

- (1) In this regulation —

***prescribed abalone*** means brownlip abalone, greenlip abalone or any combination of those 2 species of abalone.

**Fish Resources Management Regulations 1995**

**Part 4** General regulation of fishing

**Division 3** Possession limits

**r. 16GE**

---

- (2) For the purposes of section 51(1) of the Act, the maximum quantity of abalone that a person may be in possession of, other than at the person's principal place of residence, is —
- (a) 20 abalone that are other than prescribed abalone; and
  - (b) 10 prescribed abalone.
- (3) For the purposes of section 51(1) of the Act, the maximum quantity of abalone that a person may have at the person's principal place of residence is —
- (a) 80 abalone that are other than prescribed abalone; and
  - (b) 20 prescribed abalone.

*[Regulation 16GD inserted in Gazette 29 Jan 2013 p. 306.]*

**16GE. Fish on fishing boats (commercial)**

- (1) The maximum quantity of fish of a type specified in an item of the Table that a master of a fishing boat may be in possession of on that boat is as set out in that item.

**Table**

<b>Item</b>	<b>Type of fish</b>	<b>Number of fish</b>
1.	Billfish (marlins, sailfish and spearfish) and swordfish Tuna, Southern Bluefin Tuna, Longtail (Northern Bluefin)	0
2.	Tuna, yellowfin and bigeye	2
3.	Mackerel, jack, Peruvian jack, yellowtail jack and blue Tuna, albacore, longtail and skipjack Redbait Fish of the <u>Family</u> Bramidae when taken in WA waters outside the 200 m isobath	10

- (2) For the purposes of this regulation, the master of a fishing boat on which any fish are held or transported is to be taken to be in possession of the fish.
- (3) This regulation does not apply —
- (a) to fish taken in accordance with a Fishing Permit or Statutory Fishing Right granted under the Commonwealth Act; or
  - (b) where all the fish held or transported on the fishing boat were taken solely for a non-commercial purpose.
- (4) The master of a fishing boat must not be in possession of more fish on that boat than is specified in the Table to subregulation (1).

Penalty: In the case of an individual, a fine of \$5 000 or, in the case of a body corporate, a fine of \$10 000.

*[Regulation 16GE inserted in Gazette 29 Jan 2013 p. 306-7; amended in Gazette 30 May 2014 p. 1715.]*

*[Subdivision 2 (r. 16FA and 16F) deleted in Gazette 29 Jan 2013 p. 307.]*

**Subdivision 3 — Possession limits — pink snapper at Shark Bay**

*[Heading inserted in Gazette 1 Oct 2003 p. 4291.]*

**16G. Terms used**

In this Subdivision —

***fishing year*** means calendar year excluding the period beginning on 15 August and ending on 30 September in that year;

***Freycinet Estuary area*** means —

- (a) the waters of the Freycinet Estuary; and
- (b) land that is within 50 m of the high water mark of the Freycinet Estuary.

*[Regulation 16G inserted in Gazette 1 Oct 2003 p. 4291-2; amended in Gazette 6 Apr 2004 p. 1133.]*

**16H. Pink snapper in Freycinet Estuary area**

- (1) A person in or on the Freycinet Estuary area must not have any pink snapper in his or her possession.
- (2) It is a defence in proceedings against a person under section 51(2) of the Act in respect of the possession of a pink snapper in or on the Freycinet Estuary area that the person had possession of not more than 2 pink snapper and that each of those pink snapper —
  - (a) was at least 500 mm and not more than 700 mm in length; and
  - (b) had a current tag issued to the person under regulation 16I and marked with the date on which the pink snapper was taken attached to it in accordance with subregulation (3).
- (3) For the purposes of subregulation (2)(b) a tag must be attached to a pink snapper by passing the tag through the unsevered bottom jaw of the pink snapper and securing the tag through the tag's locking device in such a manner that the tag is locked and intact and cannot be reused.

*[Regulation 16H inserted in Gazette 1 Oct 2003 p. 4292; amended in Gazette 4 Nov 2005 p. 5308; 27 Aug 2013 p. 4053; 30 May 2014 p. 1715.]*

**16I. Tags authorising possession of pink snapper in Freycinet Estuary area, application for and issue of**

- (1) A person may apply to the CEO for the issue of up to 2 tags authorising the person to possess one pink snapper per tag in the Freycinet Estuary area.
- (2) An application may be made by electronic or written application in the manner, and during the period, approved by the CEO.
- (3) An application is to be made in the form approved by the CEO.

*[(4), (5) deleted]*



- (6) If —
- (a) a person makes a written or electronic application during the period approved under subregulation (2); and
  - (b) that person has not made any other written or electronic application under subregulation (1) during that period; and
  - (c) the CEO has not issued more than 1 050 tags pursuant to written or electronic application during that period; and
  - (d) the CEO determines by ballot conducted in a manner approved by the CEO that the person is eligible to be issued with a tag; and
  - (e) the fee set out in Schedule 1 Part 3 item 7 is paid,
- the CEO may issue a tag to the person.
- (7) When a tag is issued to a person the CEO is to record the name of the person on the tag.
- (8) A tag is current for the fishing year in which it is issued.
- [Regulation 16I inserted in Gazette 1 Oct 2003 p. 4293-4; amended in Gazette 6 Apr 2004 p. 1133; 7 Mar 2006 p. 975; 6 Jul 2007 p. 3389.]*

**16J. Form of tag issued under r. 16I**

A tag issued under regulation 16I —

- (a) is to be in a form approved by the CEO;
- (b) is to specify —
  - (i) the fishing year for which the tag is current; and
  - (ii) a distinguishing letter and number (tag serial number) allocated in respect of the tag.

*[Regulation 16J inserted in Gazette 1 Oct 2003 p. 4294; amended in Gazette 6 Jul 2007 p. 3389.]*

**Subdivision 4 — Possession limits in Abrolhos Islands**

*[Heading inserted in Gazette 1 Oct 2003 p. 4295; amended in Gazette 29 Jan 2013 p. 308.]*

**16K. Finfish in Abrolhos Islands reserve or Abrolhos Islands Fish Habitat Protection Area (Act s. 51(1))**

For the purposes of section 51(1) of the Act, the maximum quantity of finfish that a person may be in possession of —

- (a) in the Abrolhos Islands reserve; or
  - (b) in the Abrolhos Islands Fish Habitat Protection Area,
- is —
- (c) 10 kg of fillets of finfish; or
  - (d) one day's bag limit of whole fish or fish trunks.

*[Regulation 16K inserted in Gazette 19 Dec 2008 p. 5362; amended in Gazette 30 May 2014 p. 1715.]*

*[16L-18. Deleted in Gazette 29 Jan 2013 p. 308.]*

*[19. Deleted in Gazette 1 Oct 2003 p. 4297.]*

**Subdivision 5 — Miscellaneous**

*[Heading inserted in Gazette 29 Jan 2013 p. 308.]*

**20. Defence prescribed (Act s. 51(2))**

It is a defence in proceedings for an offence against section 51(2) of the Act that the person was acting in accordance with an authority to fish for fish for scientific purposes issued under regulation 178.

*[Regulation 20 amended in Gazette 30 Aug 1996 p. 4319; 4 Jul 1997 p. 3475; 30 Sep 1997 p. 5417; 1 Oct 2003 p. 4297-8; 4 Nov 2005 p. 5309.]*

**21. People presumed to be in possession of fish (Act s. 51)**

- (1) In any proceedings for an offence against section 51 of the Act, in the absence of proof to the contrary —

- (a) a person using, or in control of, a vehicle in which fish are found is taken to be in possession of the fish; and
- (b) a person using or in control of a refrigerator, freezer, icebox, or other storage device in which fish are found is taken to be in possession of the fish.

*[(2) deleted]*

*[Regulation 21 inserted in Gazette 1 Oct 2003 p. 4298-9; amended in Gazette 29 Jan 2013 p. 308.]*

#### **Division 4 — Labelling of fish**

*[Heading inserted in Gazette 1 Oct 2003 p. 4299.]*

### **22. Labelling requirements for packed or stored fish**

- (1) A person who packages or stores fish must ensure that a label, as described in subregulation (2), is securely attached to each package containing fish and to each fish that is stored other than in a package.

Penalty: \$5 000 and the penalty provided in section 222 of the Act.

- (2) For the purposes of subregulation (1) a label must —
  - (a) be not less than 75 mm in length and 25 mm in width; and
  - (b) have legibly written on it the full name of the owner of the fish or package to which the label is attached; and
  - (c) be attached to the fish or package in such a manner that it is clearly visible for inspection.
- (3) Subregulation (1) does not apply to, and in respect of —
  - (a) fish taken for a commercial purpose by a person in accordance with an authorisation; or
  - (b) fish kept, bred, hatched or cultured by the person in accordance with an aquaculture licence; or

**Fish Resources Management Regulations 1995**

**Part 4** General regulation of fishing

**Division 4** Labelling of fish

**r. 22**

---

- (c) fish of the Family Atherinidae, Clupeidae, Engraulidae, Hemirhamphidae or Mugilidae; or
  - (d) fish —
    - (i) in the possession and under the direct physical control of the person who took the fish; and
    - (ii) packaged or stored together only with fish taken by the same person;or
  - (e) fish taken by a person on, or who has just completed, a day trip; or
  - (f) fish taken by a person and packaged or stored with fish not taken by the person, if —
    - (i) the quantity of fish packaged or stored together does not exceed the total of the maximum quantity of fish that one person may be in possession of in accordance with regulation 16D; and
    - (ii) no other fish are packaged or stored by the person.
- (4) For the purposes of subregulation (1), a person using or having control of —
- (a) a vehicle in which fish is present; or
  - (b) a refrigerator, freezer, icebox, or other storage container in which fish is present,
- is, in the absence of proof to the contrary, to be taken to have packaged or stored the fish.
- (5) In this regulation —
- day trip*** has the same meaning as in regulation 16E;
- package*** means any type of wrapping, package, or container;

**store**, in relation to fish, includes the act of placing in a refrigerator, freezer, icebox, or other storage container.

*[Regulation 22 inserted in Gazette 1 Oct 2003 p. 4299-300; amended in Gazette 4 Nov 2005 p. 5309-10; 22 Dec 2005 p. 6221; 29 May 2008 p. 2057; 28 Jun 2013 p. 2890.]*

*[Division 3: Former heading and r. 23-29 deleted in Gazette 1 Oct 2003 p. 4299.]*

*[Division 3A: Heading and r. 29A-29C deleted in Gazette 1 Oct 2003 p. 4299.]*

*[Division 4: Former heading and r. 30 deleted in Gazette 1 Oct 2003 p. 4299.]*

*[Division 4A: Heading and r. 30A, 30B deleted in Gazette 1 Oct 2003 p. 4299.]*

*[Division 4B: Heading and r. 30BA, 30C, 30E-30EC deleted in Gazette 1 Oct 2003 p. 4299; r. 30D deleted in Gazette 28 Feb 2003 p. 661.]*

*[Division 4C-4F: Headings and r. 30F-30M deleted in Gazette 1 Oct 2003 p. 4299.]*

## **Division 5 — Requirements regarding rock lobsters**

### **31. Rock lobster: permitted ways to fish for and tail marking**

(1) In this regulation —

**allowed time**, in relation to a rock lobster, means —

- (a) where a boat is used in connection with the taking of the rock lobster, within 5 minutes of bringing the rock lobster to the boat; or
- (b) where a boat is not used in connection with the taking of the rock lobster, within 5 minutes of bringing the rock lobster onto land;

**tail clip** means the removal of the bottom half of the central segment (telson) of the tail fan of a rock lobster by horizontal cut, so that only the upper portion of the telson remains attached to the last (6th) segment of the rock lobster tail;

**tail punch** means the punching of a circular hole of no less than 10 mm in diameter in the central segment (telson) of the tail fan of a rock lobster by any means.

- (2) A person must not fish for rock lobster other than —
- (a) by hand —
    - (i) without the use of an instrument; or
    - (ii) using an instrument which is not capable of piercing a rock lobster,and without piercing or damaging the rock lobster; or
  - (b) by means of using or submerging at any one time not more than 2 rock lobster pots which —
    - (i) are attached to a surface float which conforms to the requirements of regulation 32; and
    - (ii) are pulled from the water personally by the person.

Penalty: a fine of \$5 000 and the penalty provided in section 222 of the Act.

- (3) A person who takes and keeps any rock lobster must tail clip or tail punch the rock lobster within the allowed time.

Penalty: a fine of \$5 000 and the penalty provided in section 222 of the Act.

- (4) It is a defence in proceedings for an offence against subregulation (2) or (3) for the person charged to prove that the person was acting under the authority of a managed fishery licence granted in respect of rock lobster.

*[Regulation 31 inserted in Gazette 27 Aug 2013 p. 4054-5.]*

**31A. Bait for rock lobster, limits on type of**

- (1) A person must not fish for rock lobster using as bait —
- (a) any bovine material other than gelatine or tallow; or
  - (b) any skin or hide; or
  - (c) anything to which any mammal skin or hide is attached;  
or
  - (d) any lobster material.

Penalty: \$10 000 and the penalty provided in section 222 of the Act.

- (2) The master of a boat used or intended to be used to fish for rock lobster must not cause or permit to be carried on the boat —
- (a) any bovine material other than gelatine or tallow; or
  - (b) any skin or hide; or
  - (c) anything to which any mammal skin or hide is attached;  
or
  - (d) any lobster material,

for use as bait.

Penalty: \$10 000.

- (3) Subregulations (1)(b) and (2)(b) do not apply to the skin of any fish other than rock lobster.
- (4) It is a defence in proceedings for an offence against subregulation (2) that the bovine material or skin or hide —
- (a) was food intended for human consumption; or
  - (b) was human clothing intended to be used as human clothing.

*[Regulation 31A inserted in Gazette 29 Nov 2002 p. 5654-5.]*

**32. Rock lobster pot floats, requirements for**

- (1) A person must not use a rock lobster pot to fish for rock lobster unless the rock lobster pot is attached to a surface float that —

**Fish Resources Management Regulations 1995**

**Part 4** General regulation of fishing

**Division 5** Requirements regarding rock lobsters

**r. 35**

---

- (a) has a diameter of not less than 150 mm if the float is spherical and, in any other case, has a length of not less than 200 mm and a width of not less than 100 mm; and
- (b) is marked by branding or stamping with legible characters not less than 60 mm high and not less than 10 mm wide showing —
  - (i) in the case of a pot set or pulled from a licenced fishing boat, the licensed fishing boat number of the boat; or
  - (ii) in the case of a pot set or pulled other than from a licenced fishing boat, the gear identification number of the person setting or pulling the pot;and
- (c) is marked with only one of the numbers referred to in paragraph (b).

Penalty: \$5 000.

- (2) A fisheries officer may seize a rock lobster pot and all floats and ropes if —
  - (a) the pot is not attached to a surface float; or
  - (b) the surface float to which the pot is attached does not comply with subregulation (1).

*[Regulation 32 amended in Gazette 27 Aug 2013 p. 4055.]*

*[33, 34. Deleted in Gazette 27 Aug 2010 p. 4106.]*

**35. Rock lobster flesh, possession of**

A person must not possess or sell a part only of a rock lobster unless —

- (a) authorised to do so under a fish processor's licence and the part is a part of a whole rock lobster which was processed at the place specified in the licence as the place at which fish are to be processed; or



- (b) the part was purchased from the place specified in a fish processor's licence as the place at which rock lobster is to be processed and the person has a receipt detailing that purchase; or
- (c) the part is —
  - (i) being consumed; or
  - (ii) prepared, or being prepared, for immediate consumption.

Penalty: In the case of an individual, \$5 000 or, in the case of a body corporate, \$10 000 and in either case, the penalty provided in section 222 of the Act.

*[Regulation 35 amended in Gazette 4 Nov 2005 p. 5310.]*

**36. Boats (not fishing boats) used to fish for rock lobsters, rules for**

- (1) The master of a boat, other than a fishing boat, must not cause or permit —
  - (a) more than 6 rock lobster pots to be carried on the boat at any time; or
  - (b) a person on board the boat to pull a rock lobster pot unless that person is the holder of a recreational fishing licence specifying that the holder may fish for rock lobsters; or
  - (c) more than 6 rock lobster pots to be pulled by persons on board the boat —
    - (i) if the boat makes more than one voyage in a day, during any one voyage; or
    - (ii) if the boat —
      - (I) makes only one voyage in a day; or

**Fish Resources Management Regulations 1995**

**Part 4** General regulation of fishing

**Division 5** Requirements regarding rock lobsters

**r. 37**

---

(II) is on a voyage lasting more than one day,

during any one day.

(2A) Subregulation (1)(a) does not apply in respect of a licensed carrier boat carrying unbaited rock lobster pots under the terms of its licence.

(2) The master of a fishing boat must not cause or permit any person on board the boat to pull a rock lobster pot unless —

(a) the use of that pot is authorised under an authorisation granted under section 66 of the Act; or

(b) the use of that pot is authorised under a rock lobster pot licence.

Penalty: \$5 000.

*[Regulation 36 amended in Gazette 10 Nov 2006 p. 4707; 6 Jul 2007 p. 3387; 5 Nov 2009 p. 4412; 25 Sep 2012 p. 4520.]*

**37. Offences against r. 36, defences for**

In any proceedings for an offence referred to in paragraph (a) or (b), it is a defence for the person charged to prove that the person did not know and could not reasonably have known that —

(a) in the case of an alleged offence against regulation 36(1)(b), the person who pulled the rock lobster pot did not hold a recreational fishing licence specifying that the holder may fish for rock lobsters; or

(b) in the case of an alleged offence against regulation 36(1)(c), 6 rock lobster pots had already been pulled by persons on board the boat in the relevant period.

*[Regulation 37 amended in Gazette 25 Sep 2012 p. 4520.]*

**38. Rock lobster pots, requirements for**

(1) In this regulation —

**Central West Zone** means the waters off the west coast bounded by a line commencing at the high water mark at 30° 51.06' south latitude (south of Wedge Island) and extending — west along the parallel to the intersection with 115° 10.32' east longitude;

then north-north-westerly along the geodesic to the point 30° 30.54' south latitude and 115° 0.06' east longitude;

then northerly along the geodesic to the point 30° 25.02' south latitude and 114° 58.5' east longitude;

then northerly along the geodesic to the point 30° 12.42' south latitude and 114° 57' east longitude;

then northerly along the geodesic to the point 30° 4.2' south latitude and 114° 54.42' east longitude;

then northerly along the geodesic to the point 29° 54.96' south latitude and 114° 53.52' east longitude;

then north-north-westerly along the geodesic to the point 29° 47.82' south latitude and 114° 50.64' east longitude;

then north-easterly along the geodesic to the point 29° 44.28' south latitude and 114° 52.2' east longitude;

then northerly along the geodesic to the point 29° 35.16' south latitude and 114° 53.58' east longitude;

then east along the parallel to its intersection with the high water mark (north of Freshwater Point);

then generally southerly along the high water mark to the commencement point;

**Easter Group Zone** means the waters of the Easter Group bounded by a line commencing at the point 28° 38.128' south latitude and 113° 38.951' east longitude and extending — generally easterly along the geodesic to the point 28° 36.66' south latitude and 113° 54.402' east longitude;

then generally southerly along the geodesic to the point 28° 44.415' south latitude and 113° 53.496' east longitude;

then south-westerly along the geodesic to the point 28° 48.924' south latitude and 113° 45.5' east longitude;

then generally westerly along the geodesic to the point 28° 48.71' south latitude and 113° 43.602' east longitude;

then generally north-westerly along the geodesic to the commencement point;

**internal SLED** means a sea lion exclusion device consisting of a rod inside a rock lobster pot secured to the base of the pot and rising vertically towards the neck;

**Pelsaert Group Zone** means the waters of the Pelsaert Group bounded by a line commencing at the point 28° 51.579' south latitude and 113° 47.171' east longitude and extending — north-westerly along the geodesic to the point 28° 50.308' south latitude and 113° 49.270' east longitude; then westerly along the geodesic to the point 28° 50.158' south latitude and 114° 2.323' east longitude; then south along the geodesic to the point 28° 53.456' south latitude and 114° 2.133' east longitude; then south-westerly along the geodesic to the point 28° 59.577' south latitude and 113° 58.218' east longitude; then westerly along the geodesic to the point 28° 59.506' south latitude and 113° 55.205' east longitude; then north-westerly along the geodesic to the point 28° 56.93' south latitude and 113° 51.251' east longitude; then generally north-westerly along the geodesic to the commencement point;

**Sea Lion Protection Zone** means the Central West Zone, Easter Group Zone or Pelsaert Group Zone.

- (2) A person must not use a rock lobster pot to fish for rock lobster —
- (a) in the waters north of 21° 44' south latitude, unless the pot conforms to the specifications set out in Part 1 of Schedule 13; and
  - (b) in the waters between 21° 44' south latitude and 34° 24' south latitude, but excluding the waters off the south coast east of 115° 08.091' east longitude, unless the pot conforms to the specifications set out in Part 2 of Schedule 13; and

- (c) in all waters other than those referred to in paragraphs (a) and (b), unless the pot conforms to the specifications set out in Part 3 of Schedule 13.

Penalty: \$5 000.

- (3) A person must not use a rock lobster pot to fish for rock lobster in the Sea Lion Protection Zone unless the pot is constructed with, or has fitted to it, a device (a *sea lion exclusion device*) that —
  - (a) prevents a spherical object with a diameter of 132 mm being able to enter the pot through the neck; and
  - (b) complies with subregulation (4).

Penalty: \$5 000.

- (4) A sea lion exclusion device complies with this subregulation if —
  - (a) it is made of non-flexible material; and
  - (b) it is —
    - (i) constructed; and
    - (ii) secured to the pot, in such a way that it is unlikely that it could be bent, broken, pushed aside or removed by a sea lion; and
  - (c) it does not have any sharp points, spikes or sharp edges; and
  - (d) in the case of an internal SLED, at every point along the device (but not including any bracket or other thing used to secure the rod to the base of the pot) —
    - (i) the shortest cross-sectional measurement is not less than 10 mm; and
    - (ii) the longest cross-sectional measurement is not more than 30 mm.

*[Regulation 38 amended in Gazette 31 Oct 2003 p. 4562; 10 Nov 2006 p. 4707-8; 4 Sep 2007 p. 4519; 1 Mar 2011 p. 673-5.]*

**Division 5A — Requirements regarding deep sea crabs**

*[Heading inserted in Gazette 21 Dec 1999 p. 6407.]*

**38A. Term used: deep sea crab**

In this Division —

***deep sea crab*** means a champagne crab, crystal crab or giant crab.

*[Regulation 38A inserted in Gazette 21 Dec 1999 p. 6407; amended in Gazette 13 Nov 2007 p. 5691.]*

**38B. Possession and sale of parts of deep sea crabs**

A person must not possess or sell a part only of a deep sea crab unless —

- (a) authorised to do so under a fish processor's licence, and the part is a part of a whole deep sea crab which was processed at the place specified in the licence as the place at which fish are to be processed; or
- (b) the part was purchased from the place specified in a fish processor's licence as the place at which deep sea crabs are to be processed, and the person has a receipt detailing that purchase; or
- (c) the part is —
  - (i) being consumed; or
  - (ii) prepared, or being prepared, for immediate consumption.

Penalty: In the case of an individual, \$5 000 or, in the case of a body corporate, \$10 000 and, in either case, the penalty provided in section 222 of the Act.

*[Regulation 38B inserted in Gazette 21 Dec 1999 p. 6407; amended in Gazette 4 Nov 2005 p. 5311.]*

**38C. Parts of deep sea crabs not to be landed**

A person must not bring onto land, or attempt to bring onto land, a part only of a deep sea crab.

Penalty: In the case of an individual, \$5 000 or, in the case of a body corporate, \$10 000 and, in either case, the penalty provided in section 222 of the Act.

*[Regulation 38C inserted in Gazette 21 Dec 1999 p. 6407; amended in Gazette 4 Nov 2005 p. 5311.]*

**Division 5B — Requirements regarding abalone and sea urchins**

*[Heading inserted in Gazette 1 Oct 2003 p. 4301; amended in Gazette 27 Aug 2013 p. 4055.]*

*[38DA. Deleted in Gazette 22 Oct 2014 p. 4087.]*

**38D. When fishing for abalone and sea urchins allowed**

(1) In this regulation —

*fishing season* means —

- (a) for Abalone Zone 1, between 7.00 a.m. and 8.00 a.m. on the first Sunday in January, February, March, November and December in any year;
- (b) for Abalone Zones 2 and 3, the period beginning on 1 October in any year and ending on 15 May in the following year.

(2) A person must not fish for abalone in Abalone Zone 1, 2 or 3 unless —

- (a) the person is authorised to take abalone under a managed fishery licence; or
- (b) the person fishes for abalone in the fishing season for that Abalone Zone.

Penalty: a fine of \$5 000 and the penalty provided in section 222 of the Act.

**Fish Resources Management Regulations 1995**

**Part 4** General regulation of fishing

**Division 5B** Requirements regarding abalone and sea urchins

**r. 38E**

---

- (3) A person must not fish for sea urchins in Abalone Zone 1, 2 or 3 unless —
- (a) the person is authorised to take sea urchins under a commercial fishing licence; or
  - (b) the person fishes for sea urchins in the fishing season for that Abalone Zone.

Penalty: a fine of \$5 000 and the penalty provided in section 222 of the Act.

*[Regulation 38D inserted in Gazette 27 Aug 2013 p. 4055-6.]*

**38E. Diving for abalone using breathing apparatus prohibited in Abalone Zone 1**

A person must not fish for abalone in Abalone Zone 1 by diving while using compressed air breathing apparatus.

Penalty: \$5 000 and the penalty provided in section 222 of the Act.

*[Regulation 38E inserted in Gazette 28 Nov 2003 p. 4775.]*

**38F. Use of abalone material as bait**

A person must not fish for any fish using as bait any abalone material.

Penalty: a fine of \$10 000 and the penalty provided in section 222 of the Act.

*[Regulation 38F inserted in Gazette 2 Aug 2011 p. 3166-7.]*

**38GA. Possession of abalone material**

A person, other than a person authorised to take abalone under a managed fishery licence, must not —

- (a) on the seaward side of the high water mark; or



- (b) in the waters of any estuary, river or inlet, or in the entrance to any of those waters,

be in possession of any abalone material other than a whole abalone.

Penalty: a fine of \$10 000.

*[Regulation 38GA inserted in Gazette 2 Aug 2011 p. 3167; amended in Gazette 2 Nov 2011 p. 4620.]*

### **Division 5C — Requirements regarding marron**

*[Heading inserted in Gazette 29 Dec 2000 p. 7968.]*

#### **Subdivision 1 — Interpretation**

*[Heading inserted in Gazette 29 Dec 2000 p. 7968.]*

### **38G. Terms used**

In this Division —

***closed season***, in any year, means all of that year other than the period commencing midday on 8 January and ending midday on 5 February;

***marron drop net*** means a net that —

- (a) has a base ring and top ring that have a diameter of not less than 400 mm and not more than 650 mm; and
  - (b) has within the base ring an internal rigid rectangular mesh —
    - (i) constructed of material that has a diameter of not more than 5 mm; and
    - (ii) with spaces that have a width of not less than 32 mm and a length of not less than 80 mm;
- and
- (c) does not have anything attached to it or placed in it that —
    - (i) restricts the movement of marron through the mesh; or

- (ii) reduces the size of the spaces of the mesh;

**marron pole snare** means a snare that —

- (a) is constructed of a pole to one end of which is attached a noose that, when the pole is used to take a marron, operates by closing under the weight of the marron; and
- (b) does not have anything attached to the pole that enables a person to open or close the noose;

**marron scoop net** means a net that —

- (a) is generally hemispherical and has a mesh —
- (i) constructed of wire with a diameter of not more than 5 mm; and
- (ii) that does not have more than 75 spaces; and
- (iii) that does not have more than 6 support wires radiating from the centre of the base to the top rim;

and

- (b) has a circular top ring with an internal diameter that does not exceed 375 mm; and
- (c) has an internal depth that, measured from the plane of the rim, is not more than 210 mm; and
- (d) does not have anything attached to it or placed in it that restricts the movement of marron through the mesh; and
- (e) is fitted with a handle that is not more than 1 400 mm in length.

*[Regulation 38G inserted in Gazette 29 Dec 2000 p. 7968-9; amended in Gazette 13 Dec 2002 p. 5796-7; 9 Jan 2004 p. 141; 30 Nov 2004 p. 5487; 22 Dec 2005 p. 6221; 29 Dec 2006 p. 5890; 13 Oct 2009 p. 4032.]*

**Subdivision 2 — General restrictions on fishing for marron**

*[Heading inserted in Gazette 29 Dec 2000 p. 7969.]*

**38H. Marron, permitted ways to fish for**

Subject to regulation 38I, a person must not fish for marron by using anything except —

- (a) not more than 6 marron drop nets; or
- (b) a single marron pole snare; or
- (c) a single marron scoop net.

Penalty: For a first offence \$5 000 or, for a second or subsequent offence, \$10 000 and, for any offence, the penalty provided in section 222 of the Act.

*[Regulation 38H inserted in Gazette 22 Jan 2002 p. 359; amended in Gazette 1 Oct 2003 p. 4301.]*

**38I. Single marron pole snare only to be used in some waters**

- (1) A person must not fish for marron in the waters to which subregulation (2) applies by using anything except a single marron pole snare.

Penalty: For a first offence \$5 000 or, for a second or subsequent offence, \$10 000 and, for any offence, the penalty provided in section 222 of the Act.

- (2) This subregulation applies to the waters —

*[(a), (b) deleted]*

- (c) of Harvey Dam and the Harvey River upstream of the South Western Highway, including the tributaries flowing into those waters; and

*[(d) deleted]*

- (e) upstream of the Wellington Dam wall, including the tributaries flowing into those waters but not including the waters of the Collie River upstream of the Mungalup Road Bridge; and

*[(f) deleted]*

- (g) subject to regulation 38J, of the Margaret River, including its tributaries; and
- (h) of Big Brook Dam, Drakes Brook Dam, Glen Mervyn Dam, Logue Brook Dam and Lake Navarino (Waroona Dam).

*[Regulation 38I inserted in Gazette 29 Dec 2000 p. 7970-1; amended in Gazette 22 Dec 2005 p. 6221; 29 Dec 2006 p. 5890; 13 Oct 2009 p. 4032.]*

**38J. Marron fishing prohibited in certain Margaret River waters**

A person must not fish for marron in —

- (a) the Margaret River within the area that begins 300 m upstream of the Bussell Highway Bridge and ends 50 m downstream of that bridge; or
- (b) the Margaret River upstream of the Ten Mile Brook junction; or
- (c) the tributaries flowing into the part of the river described in paragraph (b).

Penalty: For a first offence \$5 000 or, for a second or subsequent offence, \$10 000 and, for any offence, the penalty provided in section 222 of the Act.

*[Regulation 38J inserted in Gazette 29 Dec 2000 p. 7971; amended in Gazette 13 Dec 2002 p. 5797; 13 Oct 2009 p. 4032.]*

*[38JA. Deleted in Gazette 22 Dec 2005 p. 6221.]*

**38K. Marron fishing prohibited from boats or by swimming or diving**

A person must not fish for marron —

- (a) by using a boat; or

- (b) by swimming, or diving, while using a face mask, goggles, a snorkel, flippers or similar gear.

Penalty: For a first offence \$5 000 or, for a second or subsequent offence, \$10 000 and, for any offence, the penalty provided in section 222 of the Act.

*[Regulation 38K inserted in Gazette 29 Dec 2000 p. 7971.]*

**38L. Marron nets not to be transported in boats in most cases**

- (1) A person must not use a boat in WA waters to transport a marron drop net or marron scoop net.

Penalty: For a first offence \$5 000 or, for a second or subsequent offence, \$10 000.

- (2) Subregulation (1) does not apply to a person using a boat in the waters of the Donnelly River downstream of the boat ramp at the termination of Boat Landing Road at 34° 27' south latitude (Boat Landing).

*[Regulation 38L inserted in Gazette 29 Dec 2000 p. 7971; amended in Gazette 29 Dec 2006 p. 5890.]*

**Subdivision 3 — Closed season restrictions relating to marron**

*[Heading inserted in Gazette 29 Dec 2000 p. 7972.]*

**38M. Closed season for marron fishing**

A person must not fish for marron during the closed season.

Penalty: For a first offence \$5 000 or, for a second or subsequent offence, \$10 000 and, for any offence, the penalty provided in section 222 of the Act.

*[Regulation 38M inserted in Gazette 29 Dec 2000 p. 7972.]*

**38N. Removing marron from private land in closed season**

- (1) A person must not —  
(a) remove any marron; or

(b) cause or permit any marron to be removed,

during the closed season from private land owned or occupied by the person.

Penalty: For a first offence \$5 000 or, for a second or subsequent offence, \$10 000 and, for any offence, the penalty provided in section 222 of the Act.

(2) It is a defence in proceedings for an offence against subregulation (1) for the person charged to prove that the marron removed from private land owned or occupied by the person —

(a) had been sold by retail to the public; or

(b) had been kept, bred, hatched or cultured in accordance with an aquaculture licence.

*[Regulation 38N inserted in Gazette 29 Dec 2000 p. 7972.]*

**38O. Possession of marron during non-possession period**

(1) A person must not be in possession of any marron during the non-possession period except on private land owned or occupied by the person.

Penalty: For a first offence \$5 000 or, for a second or subsequent offence, \$10 000 and, for any offence, the penalty provided in section 222 of the Act.

(2) It is a defence in proceedings for an offence against subregulation (1) for the person charged to prove that the marron in his or her possession —

(a) had been sold by retail to the public, or were at any place for the purpose of being sold by retail to the public, or served as meals to the public, in, on or from the place; or

(b) were being, or had been, kept, bred, hatched or cultured in accordance with an aquaculture licence; or

- (c) were at a place specified in a fish processor's licence under section 83(2) of the Act for the purpose of being processed in accordance with the licence.
- (3) In this regulation —
- non-possession period***, in any year, means the closed season in that year other than the first 12 hours after the end of the period referred to in the definition of ***closed season*** in regulation 38G.
- [Regulation 380 inserted in Gazette 29 Dec 2000 p. 7973; amended in Gazette 29 Dec 2006 p. 5890; 13 Oct 2009 p. 4032.]*

### **Division 6 — Requirements relating to the taking of certain fish**

#### **39. Prawns, permitted ways to fish for by recreational fishers**

- (1) A person, other than a person who is the holder of a commercial fishing licence, must not fish for prawns by means of using any fishing gear other than —
- (a) a single hand dip net; or
  - (b) subject to subregulation (2), a single prawn hand trawl net; or
  - (c) a single hand scoop net; or
  - (d) a single throw net that has a length not exceeding 3 m measured from the centre retrieval line to the lead line and a mesh of not more than 25 mm.
- (2) A person fishing for prawn using a prawn hand trawl net must not —
- (a) attach that net to a boat; or
  - (b) set the net.

Penalty: \$3 000.

*[Regulation 39 amended in Gazette 1 Oct 2003 p. 4301-2; 22 Jun 2012 p. 2779.]*

**40. Cherabin, permitted ways to fish for**

A person must not fish for cherabin by means of using any fishing gear other than —

- (a) not more than 6 complying drop nets; or
- (b) a single pole snare; or
- (c) a single hand scoop net; or
- (d) a single throw net that has a length not exceeding 3 m measured from the centre retrieval line to the lead line and a mesh of not more than 25 mm,

at any one time.

Penalty: \$2 000.

*[Regulation 40 amended in Gazette 29 Jun 2004 p. 2523;  
6 Nov 2009 p. 4471.]*

**41. Abalone, who may shuck or possess when shucked**

- (1) Subject to subregulation (2), a person, other than a person authorised to take abalone under a managed fishery licence, must not —

- (a) on the seaward side of the high water mark; or
- (b) in the waters of any estuary, river or inlet, or in the entrance to any of those waters; or
- (c) within 200 m of, and on the landward side of, the high water mark,

remove the shell, or cause or permit the shell to be removed, from an abalone.

Penalty: a fine of \$5 000 and the penalty provided in section 222 of the Act.

- (2A) A person, other than a person authorised to take abalone under a managed fishery licence, must not bring onto land, or attempt to bring onto land, an abalone from which the shell has been removed.

Penalty: a fine of \$5 000 and the penalty provided in section 222 of the Act.



- (2) Subregulation (1)(c) does not apply to a person if that person —
- (a) removes an abalone from its shell, or permits an abalone to be removed from its shell, within an area described in the Table to this regulation; and
  - (b) immediately takes the abalone from which the shell has been removed from that area to an area which is more than 200 m on the landward side of the high water mark.

**Table**

The fish cleaning facility situated approximately 40 m in an easterly direction from the intersection of Wharton Road and Road No. 17027 (access road to the Duke of Orleans Caravan Park) at the Duke of Orleans Bay.

*[Regulation 41 amended in Gazette 19 Jun 1998 p. 3263; 4 Nov 2005 p. 5311; 2 Aug 2011 p. 3167; 2 Nov 2011 p. 4621.]*

**42. Molluscs (not abalone or oyster), shucking of**

- (1) A person, other than a person who is the holder of a commercial fishing licence or an aquaculture licence, must not —
- (a) on the seaward side of the high water mark, or within 200 m of, and on the landward side of, the high water mark —
    - (i) remove the shell, or cause or permit the shell to be removed, from a cockle, ark shell, venus clam or other species of edible mollusc; or
    - (ii) be in possession of a cockle, ark shell, venus clam or other species of edible mollusc from which the shell has been removed;
- or
- (b) bring onto land, or attempt to bring onto land, a cockle, ark shell, a venus clam or any other edible mollusc from which the shell has been removed.
- (2) Subregulation (1)(a) does not apply to a person who removes the shell, or causes or permits the shell to be removed, from a

cockle (ark shell), venus clam or any other edible mollusc for the purpose of immediately consuming the mollusc or using it as bait.

- (3) This regulation does not apply in respect of abalone or oyster.

Penalty: \$2 000.

*[Regulation 42 amended in Gazette 1 Oct 2003 p. 4302;  
4 Nov 2005 p. 5311.]*

**43. Trout, obstructing etc.**

Unless authorised to do so under an authorisation, a person must not —

- (a) obstruct or attempt to obstruct the free movement of trout in any waters by means of any fixed implement or device; or
- (b) interfere with or disturb trout when spawning or when on or near their spawning beds.

Penalty: \$2 000.

**44. Barramundi, trout, freshwater cobbler and redfin perch, permitted ways to fish for**

Unless the person is authorised to do so under an authorisation, a person must not fish for —

- (a) barramundi; or
- (b) brown trout; or
- (c) freshwater cobbler; or
- (d) rainbow trout; or
- (e) redfin perch,

otherwise than by means of a single rod, reel and line or a single line held in the hand.

Penalty: \$2 000.

**44A. Freshwater fish, closed season for**

- (1) In this regulation —  
*freshwater fish* means the fish listed in Schedule 7 Division 2.
- (2) Subject to subregulation (3), a person must not fish for freshwater fish during the period from 1 July to 31 August, both dates inclusive, in any year in waters south of 29° south latitude above the tidal influence, including all lakes, dams, rivers and their tributaries.  
Penalty: a fine of \$2 000.
- (3) Subregulation (2) does not apply to a person who fishes for freshwater fish —
- (a) in waters on private land, other than waters passing through that land; or
  - (b) in the waters, including tributaries flowing into those waters, of —
    - (i) Big Brook Dam;
    - (ii) the Blackwood River;
    - (iii) the Donnelly River;
    - (iv) Glen Mervyn Dam;
    - (v) the Murray River;
    - (vi) Lake Leschenaultia;
    - (vii) Logue Brook Dam;
    - (viii) the Serpentine River, upstream of Serpentine Falls and downstream of the Serpentine Pipe-Head Dam;
    - (ix) the Warren River;
    - (x) Wellington Dam.

*[Regulation 44A inserted in Gazette 2 Nov 2011 p. 4621-2.]*

**45. Demersal scalefish in West Coast Region, closed season for recreational fishing for**

(1) In this regulation —

*closed season* means the period from 15 October to 15 December, both dates inclusive, in any year;

*demersal scalefish* means any fish listed in the Table.

**Table**

Cod	Hapuku
Cod, Grey Banded Rock	Nannygai
Coral Trout	Parrot Fish
Coronation Trout	Seaperch, Tropical
Dhufish, West Australian	Snapper, Pink
Emperor and Seabream	Snapper, Queen (Blue Morwong)
Emperor, Red (Government Bream)	Snapper, Red (Redfish)
Foxfish, Western and Pigfish	Swallowtail
Groper, Baldchin	Trevalla
Groper, Bass	Tuskfish
Groper, Western Blue	

(2) During the closed season a person must not —

- (a) fish for demersal scalefish in the West Coast Region; or
- (b) be in possession of demersal scalefish on a boat in the waters of the West Coast Region; or

- (c) bring onto land in the West Coast Region any demersal scalefish.

Penalty: For a first offence a fine of \$5 000 or, for a second or subsequent offence, a fine of \$10 000 and, for any offence, the penalty provided in section 222 of the Act.

- (3) Subregulation (2) does not apply to or in respect of demersal scalefish taken for a commercial purpose in accordance with an authorisation.

*[Regulation 45 inserted in Gazette 29 Sep 2009 p. 3866-7.]*

*[Division 7: Heading and r. 46-54 deleted in Gazette 1 Oct 2003 p. 4303; r. 55 deleted in Gazette 11 Feb 2003 p. 412.]*

### **Division 7A — Requirements relating to automatic location communicators**

*[Heading inserted in Gazette 2 Jan 1998 p. 25.]*

#### **55A. Terms used**

In this Division —

***approved automatic location communicator*** means an automatic location communicator of a make, model or type approved in accordance with regulation 55AA(1);

***approved directions*** means directions approved in accordance with regulation 55AA(3);

***automatic location communicator*** or ***ALC*** means —

- (a) an automatic device for tracking the location of a boat and transmitting accurate information as to the geographical position, course and speed of the boat; and
- (b) a computer (including software) that is capable of facilitating the operation of that device;

***licence holder*** means the holder of a fishing boat licence.

*[Regulation 55A inserted in Gazette 23 May 2006 p. 1858.]*

**55AA. ALCs, approval of; directions for use of etc.**

- (1) The CEO may by notice published in the *Gazette* approve an automatic location communicator of a particular make, model or type for the purposes of these regulations.
- (2) An automatic location communicator may be approved generally or in respect of a particular fishery specified in the notice.
- (3) The CEO may by notice published in the *Gazette* approve directions for the installation, use, servicing and testing of approved automatic location communicators for the purposes of these regulations.
- (4) Directions under subregulation (3) may specify that a particular approved automatic location communicator is to be used in, and in respect of, a particular fishery only.
- (5) The CEO may by notice amend or revoke a notice under subregulation (1) or (3).

*[Regulation 55AA inserted in Gazette 23 May 2006 p. 1858-9; amended in Gazette 6 Jul 2007 p. 3389; 18 Aug 2009 p. 3237.]*

**55B. ALC, CEO may direct installation of etc. in fishing boat**

- (1A) In this regulation —  
*notice* means a notice given under subregulation (1) and includes a notice amended under subregulation (3).
- (1) The CEO may, by notice in writing given to a licence holder, require the licence holder —
  - (a) to have installed in the fishing boat in respect of which the licence is held, in accordance with the approved directions, an approved automatic location communicator; and
  - (b) to ensure that that automatic location communicator is used, serviced and tested in accordance with the approved directions.

- (2) If notice is given to a licence holder it is a condition of the fishing boat licence that the licence holder must comply with the notice.
- (3) The CEO may by notice in writing given to the licence holder amend or revoke a notice.

*[Regulation 55B inserted in Gazette 2 Jan 1998 p. 26; amended in Gazette 23 May 2006 p. 1859; 6 Jul 2007 p. 3389; 18 Aug 2009 p. 3237-8.]*

**55C. Master of fishing boat, duties of as to ALC**

- (1) In this regulation —  
**ALC fishing boat** means a fishing boat in which an approved automatic location communicator has been installed in accordance with the approved directions.
- (2) The master of an ALC fishing boat must ensure that the approved automatic location communicator on the boat is operating effectively at all times.  
Penalty: \$10 000.
- (3) If the master of an ALC fishing boat is informed by the CEO that the ALC on the boat is not operating effectively the master must ensure that —
  - (a) all fishing undertaken from the fishing boat stops immediately and all fishing gear on the boat is stowed until the CEO authorises fishing to continue; and
  - (b) any directions given by the CEO (such as a direction that the fishing boat go to a port specified by the CEO) are complied with.Penalty: \$10 000.
- (4) The master of an ALC fishing boat must ensure —
  - (a) that there is on board the fishing boat a means of communication that is capable of providing

**Fish Resources Management Regulations 1995**

**Part 4** General regulation of fishing

**Division 7B** Requirements relating to bait bands

**r. 55D**

---

communication between the master of the fishing boat and the CEO at all times; and

- (b) that the CEO is notified of the appropriate form of identification (such as a radio call sign) that enables the master of the fishing boat to be contacted by that means of communication.

Penalty: \$10 000.

*[Regulation 55C inserted in Gazette 2 Jan 1998 p. 26-7; amended in Gazette 23 May 2006 p. 1859-60; 6 Jul 2007 p. 3389.]*

**55D. Interfering etc. with ALC or approved seal**

- (1) Subject to subregulation (2), a person must not wilfully interfere with, damage, destroy or remove —
  - (a) an approved automatic location communicator installed on a fishing boat in accordance with the approved directions; or
  - (b) a seal of the Department that has been attached in an approved manner to an approved automatic location communicator.

Penalty: \$10 000.

- (2) Subregulation (1) does not apply to or in respect of a person installing, using or testing an approved automatic location communicator in accordance with the approved directions.

*[Regulation 55D inserted in Gazette 2 Jan 1998 p. 27; amended in Gazette 23 May 2006 p. 1860.]*

**Division 7B — Requirements relating to bait bands**

*[Heading inserted in Gazette 2 Nov 2011 p. 4622.]*

**55E. Terms used**

In this Division —

***bait band*** means plastic tape used for the purpose of securing cartons of bulk bait;



**WCRL Managed Fishery** means the West Coast Rock Lobster Managed Fishery.

*[Regulation 55E inserted in Gazette 2 Nov 2011 p. 4622;  
amended in Gazette 1 Mar 2013 p. 1092.]*

**55F. Bait bands on boats prohibited**

- (1) Subject to subregulations (2), (3) and (4), the master of a boat being used for or in connection with fishing must not cause or permit any bait bands to be on board the boat.  
Penalty: a fine of \$2 000.
- (2) Subregulation (1) does not apply in relation to a licensed carrier boat being used in the WCRL Managed Fishery to transport fish taken with the use of another boat.
- (3) Subregulation (1) does not apply in relation to a boat that is authorised to be used for or in connection with the taking of rock lobster in the WCRL Managed Fishery if that boat —
  - (a) is being used in that fishery to transport bait from a licensed carrier boat to the Abrolhos Islands; or
  - (b) is a licensed fishing boat that is moored or anchored in that fishery not more than 800 m from the high water mark on the mainland or the Abrolhos Islands.
- (4) Subregulation (1) does not apply in relation to a boat being used in the WCRL Managed Fishery to transport —
  - (a) bait to or from a boat referred to in subregulation (3)(b);  
or
  - (b) bait bands from a boat referred to in subregulation (3)(b).

*[Regulation 55F inserted in Gazette 2 Nov 2011 p. 4623.]*

**Division 7C — Requirements relating to aquatic eco-tourism**

*[Heading inserted in Gazette 30 May 2014 p. 1733.]*

**55G. Activities and fish prohibited on aquatic eco-tour**

- (1) The master of a boat used for an aquatic eco-tour must not allow a participant in the tour to —
- (a) take any fish while on the boat; or
  - (b) keep any fish on the boat; or
  - (c) bring onto land any fish from the boat.

Penalty: a fine of \$2 000 and the penalty provided in section 222 of the Act.

- (2) The person in charge of any boat, vehicle or aircraft being used for an aquatic eco-tour must not —
- (a) commence the tour with any fish on the boat, vehicle or aircraft; or
  - (b) allow any fish to remain on the boat, vehicle or aircraft at the end of the tour.

Penalty: a fine of \$10 000 and the penalty provided in section 222 of the Act.

- (3) It is a defence in proceedings for an offence against subregulation (2)(a) or (b) for the person charged to prove that the fish was purchased from a person other than a participant in the tour for the purpose of providing meals for participants in the tour.

*[Regulation 55G inserted in Gazette 30 May 2014 p. 1733.]*

**55H. Shark tourism activities prohibited on aquatic eco-tour**

- (1) A participant in an aquatic eco-tour must not —
- (a) use a safety cage the purpose of which is to protect swimmers or divers from sharks; or
  - (b) engage in the tagging or marking of sharks; or
  - (c) use blood, berley or any vibrating, visual, sonic, electronic, electromagnetic or other equipment for the purpose of attracting sharks.

Penalty: a fine of \$2 000.

- (2) The person in charge of an aquatic eco-tour must not —
- (a) provide or use, or allow participants in the tour to use, a safety cage the purpose of which is to protect swimmers or divers from sharks; or
  - (b) engage, or allow participants in the tour to engage, in the tagging or marking of sharks; or
  - (c) provide or use, or allow participants in the tour to use, blood, berley or any vibrating, visual, sonic, electronic, electromagnetic or other equipment for the purpose of attracting sharks.

Penalty: a fine of \$10 000.

*[Regulation 55H inserted in Gazette 30 May 2014 p. 1734.]*

**55I. Boat not to be used for both commercial fishing and aquatic eco-tour during single trip**

A person who uses a licensed fishing boat for or in connection with commercial fishing and an aquatic eco-tour in the course of a single trip commits an offence.

Penalty: a fine of \$5 000.

*[Regulation 55I inserted in Gazette 30 May 2014 p. 1734.]*

*[55J-55L. Deleted in Gazette 1 Oct 2003 p. 4303.]*

**Division 8 — Miscellaneous requirements**

**56. Documents to be carried on licensed fishing boat**

- (1) The master of a licensed fishing boat must cause to be kept on board the boat the following documents, or legible copies of those documents —
- (a) the fishing boat licence; and
  - (b) the commercial fishing licence of each member of the crew required to hold that licence; and

- (c) any other authorisation relating to the boat or crew required to be held under the Act.

Penalty: \$1 000.

- (2) Where the CEO considers that it would be impractical to require a person to comply with subregulation (1), the CEO may exempt that person in relation to a boat or class of boats from that subregulation.

*[Regulation 56 amended in Gazette 6 Jul 2007 p. 3389.]*

**56A. Fish hooks attached to rock lobster pots, float lines, moorings etc. not to be used to fish**

A person must not fish using a fish hook attached to —

- (a) a rock lobster pot; or
- (b) a float or float line attached to a rock lobster pot; or
- (c) a boat mooring or mooring line; or
- (d) a boat anchor or anchor line.

Penalty: For a first offence \$5 000 or, for a second or subsequent offence, \$10 000 and, for any offence, the penalty provided in section 222 of the Act.

*[Regulation 56A inserted in Gazette 29 Nov 2002 p. 5655; amended in Gazette 11 Feb 2003 p. 412.]*

*[57. Deleted in Gazette 30 May 2014 p. 1715.]*

*[58. Deleted in Gazette 1 Oct 2003 p. 4303.]*

**59. Sale of fish by authorised trade names**

- (1) The authorised trade name of a species of fish set out in column 1 of Schedule 11 is the name set out opposite that species in column 2 of that Schedule.
- (2) A person must not sell fish of any species under an authorised trade name unless the fish is of the species to which the authorised trade name applies.

Penalty: \$5 000.

**60. Rock lobsters, maximum size of packages etc. of**

- (1) A person responsible for packaging rock lobster must ensure that no package, container or receptacle which contains rock lobster exceeds 45 kg in weight.
- (2) A person must not possess a bag which contains live rock lobsters if the bag measures more than one metre in depth and 600 mm in width when empty.

Penalty: \$1 000.

**61. Fish for sale etc., labelling requirements for**

- (1) A person who sells any fish to another person, other than on a retail basis, must ensure that a label, as specified in this regulation, is attached in respect of that fish.
- (2) The master of a licensed fishing boat which has been used to take rock lobster must ensure that a label, as specified in this regulation and in the form approved by the CEO, is attached in respect of that rock lobster before it is removed from the boat or sold to another person.
- (3) The label referred to in subregulations (1) and (2) must be —
  - (a) durable and made of plastic, wood or metal; and
  - (b) securely attached to the fish or the exterior of any package, container or receptacle containing the fish; and
  - (c) rectangular in shape and not less than 75 mm in length and not less than 55 mm in width.
- (3a) In relation to rock lobster, the reference in subregulation (3)(b) to the exterior of any package, container or receptacle (the *package*) is a reference to an exterior side surface of the package and does not include a reference to the exterior upper or lower surface of the package.

**Fish Resources Management Regulations 1995**

**Part 4** General regulation of fishing

**Division 8** Miscellaneous requirements

**r. 61**

---

- (4) Subject to subregulation (4a), the label referred to in subregulation (1) must specify the name and principal place of residence of the person selling the fish.
- (4a) If —
- (a) a person referred to in subregulation (1) is a nominated operator, as defined in the *Abalone Management Plan 1992*; and
  - (b) the fish referred to in that subregulation are abalone,
- the label referred to in subregulation (1) must specify —
- (c) the name of the person and the town or suburb where the person's principal place of residence is located; and
  - (d) the number of the managed fishery licence that authorised the abalone to be taken; and
  - (e) if a licensed fishing boat was used to take the abalone, the licensed fishing boat number.
- (5) The label referred to in subregulation (2) must clearly identify —
- (a) the name and principal place of residence of the master of any licensed fishing boat which was used to fish for the fish; and
  - (b) the licensed fishing boat number of any licensed fishing boat which was used to fish for the fish; and
  - (c) the fishery, and if applicable the area or zone of the fishery, from which the fish were taken.
- (6) A person must not purchase any fish unless the fish is labelled in accordance with this regulation.
- (7) A person must not remove rock lobster from a package, container or receptacle labelled in accordance with this regulation before it is received by the purchaser of the rock lobster or until the rock lobster consigned for processing at a place specified in a fish processor's licence is received at that place.
- Penalty: \$3 000.

*[Regulation 61 amended in Gazette 8 Sep 2000 p. 5186-7;  
11 Feb 2003 p. 412; 6 Jul 2007 p. 3389.]*

**62. Refuse etc. not to be deposited in waters etc. where fish are**

Subject to Part 9, a person must not deposit, or cause or permit to be deposited, any refuse or waste —

- (a) in any waters; or
- (b) in any place that might result in the pollution of any waters,

where fish are or are likely to be.

Penalty: \$10 000.

**63A. Use of berley containing mammal or bird products**

- (1) In this regulation —

*mammal or bird products* means blood, flesh, offal or skin from a mammal or from a bird.

- (2) A person must not, in WA waters, use berley containing mammal or bird products.

Penalty: a fine of \$10 000.

- (3) Subregulation (2) does not apply in respect of berley that is in the form of processed bait pellets.

- (4) It is a defence in proceedings for an offence against subregulation (2) for the person charged to prove that the mammal or bird product contained in the berley was used, in accordance with the Act, as bait —

- (a) in a crab drop net, rock lobster pot or other trap or device for trapping fish; or
- (b) attached to a fish hook.

*[Regulation 63A inserted in Gazette 18 Jun 2013 p. 2296.]*

**63. Fishing gear prohibited from use in waters, possession of**

- (1) Where, under the Act, it is prohibited for a person to use any fishing gear in any waters the person must not —
- (a) possess that gear on, or in, those waters or any land adjacent to those waters; or
  - (b) carry that gear on any boat of which the person is master,

unless in accordance with the written approval of a fisheries officer.

Penalty: \$5 000.

- (2) If the fishing gear was securely stowed and did not contain any fish, it is a defence in proceedings for an offence against subregulation (1) for the person charged to prove that —
- (a) in respect of all boats —
    - (i) the person had no reasonable alternative than to carry the fishing gear through the waters; and
    - (ii) the boat was being used solely for the purpose of travelling by the shortest practicable and most direct route through the waters to, or from, the nearest boat launching facility to waters where the fishing gear could be lawfully used;or
  - (b) the person was the master of a licensed fishing boat and had a reasonable excuse —
    - (i) to be alongside a service jetty or wharf, or on a mooring in a recognised anchorage within the waters; or
    - (ii) to travel to, or from, a service jetty, wharf or anchorage within the waters by the shortest practicable and most direct route, to waters where the fishing gear could lawfully be used;or



- (c) due to the person's particular circumstances, the person had no reasonable alternative but to be on the land adjacent to the waters with the fishing gear.

**64. Commercial fishers etc., duties of as to records and returns**

- (1A) In this regulation —

***person engaged for a commercial purpose in an activity*** means —

- (a) in the case of an activity referred to in subregulation (2)(a), (b) or (c) that is carried out using a boat which has a master, the master of the boat; or
- (b) in any other case, the holder of the authorisation under which the activity is carried out;

***return*** includes a return regarding an activity that a person is authorised to engage in under an authorisation showing that the activity was not engaged in during a month.

- (1) A person engaged for a commercial purpose in any activity referred to in subregulation (2) must keep records relevant to that activity relating to the following matters and must retain those records for a period of not less than 7 years —
  - (a) the catch of fish;
  - (b) sales of fish or fish products;
  - (c) output of fish or fish products;
  - (d) purchases of fish or fish products;
  - (e) receipts of fish or fish products;
  - (f) fishing gear or equipment bought, sold or used;
  - (g) times and places of fishing, or carrying out the relevant business of the person;
  - (h) stocks of live fish and live fish production.
- (2) For the purposes of subregulation (1), the activities are —
  - (a) taking fish for sale;

**Fish Resources Management Regulations 1995**

**Part 4** General regulation of fishing

**Division 8** Miscellaneous requirements

**r. 64**

---

- (b) taking any species of fish for use as bait by persons engaged in commercial fishing;
  - (c) taking for any purpose not prohibited under section 47 of the Act any commercially protected fish;
  - (d) dealing in or purchasing for resale, or exporting or importing, live fish or their products;
  - (e) aquaculture;
  - (f) selling fish at a market or at an establishment at which fish are sold that have not passed through a market;
  - (g) processing fish;
  - (h) transporting fish or fish products;
  - (i) purchasing or receiving fish;
  - (j) operating a charter boat;
  - (k) conducting a fishing tour.
- (3) A person who is the holder of a fishing boat licence or carrier boat licence must keep a record in a form approved by the CEO of the name, address and details of any commercial fishing licence held by a person who for any period is the master, or has the day to day control, of the boat in respect of which the licence is held.
- (4) Subject to subregulation (6), a person who is to keep records under this regulation must submit a return to the Department regarding the activity each month and, where the CEO has approved a form for that activity, must —
- (a) use the relevant form approved by the CEO; and
  - (b) send the return relating to each month —
    - (i) to the head office of the Department in Perth; or
    - (ii) if another office of the Department is specified in the relevant form, to that office,to arrive —
    - (iii) not later than the 15th day of the following month; or

- (iv) if a later day is specified in the relevant form, not later than that day.
- (5) A person who purchases or receives any fish must ensure that the record to be kept under this regulation —
  - (a) exists or is made at the time that the fish is purchased or received; and
  - (b) specifies —
    - (i) the quantity and species of the fish purchased or received; and
    - (ii) the date of that purchase or receipt; and
    - (iii) the name and address of the person from whom the fish were purchased or received;
  - and
  - (c) is kept at the place where the fish are purchased or received.
- (6) The CEO may exempt a person who is to keep records under this regulation from submitting a monthly return under subregulation (4) for the period of time, or in respect of the activities, specified in writing and sent to the person who is to be exempt.
- (6a) A person who has conducted a fishing tour on a boat must complete the records referred to in subregulation (1) before any participant in the tour leaves the boat.
- (7) A person must not make an entry or statement that is false or misleading in a material particular in a record kept or a return submitted under this regulation.

Penalty: In the case of an individual \$5 000 or, in the case of a body corporate, \$10 000 and in either case in relation to an offence under subregulation (5), the penalty provided in section 222 of the Act.

*[Regulation 64 amended in Gazette 15 Jan 1999 p. 113;  
13 Aug 1999 p. 3826; 29 Jun 2001 p. 3164; 27 Jun 2003*

*p. 2389; 6 Jul 2007 p. 3389; 5 Nov 2009 p. 4412; 1 Mar 2011 p. 667; 26 Aug 2014 p. 3082.]*

**64AA. No fish taken for recreational purpose to be at certain premises**

- (1) In this regulation —  
*commercial premises* means premises at which a person engages for a commercial purpose in an activity mentioned in regulation 64(2)(d) to (i).
- (2) A person must not, at commercial premises, be in possession of fish that were taken for a recreational purpose.  
Penalty: In the case of an individual, a fine of \$5 000 or, in the case of a body corporate, a fine of \$10 000 and in either case, the penalty provided in section 222 of the Act.
- (3) For the purposes of subregulation (2) fish is to be taken to have been taken for a recreational purpose if no record of the purchase or receipt of the fish has been kept under regulation 64.
- (4) It is a defence in proceedings for an offence under subregulation (2) for the person charged to prove that the person was in possession of the fish on a part of the premises that is a residence.

*[Regulation 64AA inserted in Gazette 30 May 2014 p. 1716.]*

## **Part 4A — Requirements regarding fishing gear**

*[Heading inserted in Gazette 1 Oct 2003 p. 4304.]*

### **Division 1 — Preliminary**

*[Heading inserted in Gazette 1 Oct 2003 p. 4304.]*

#### **64A. Order of precedence of Div. 2, 3 and 4**

If there is conflict or inconsistency between the provisions of Division 2, 3 or 4 then, to the extent of the conflict or inconsistency —

- (a) the provisions of Division 3 prevail over the provisions of Division 2; and
- (b) the provisions of Division 4 prevail over the provisions of Divisions 2 and 3.

*[Regulation 64A inserted in Gazette 1 Oct 2003 p. 4304.]*

#### **64B. Term used: attend**

In this Part —

**attend** in respect of a line, means to be within 10 m of the line.

*[Regulation 64B inserted in Gazette 1 Oct 2003 p. 4304.]*

### **Division 2 — Statewide requirements regarding fishing gear**

*[Heading inserted in Gazette 1 Oct 2003 p. 4304.]*

#### **64CA. Prohibited fishing methods**

A person must not fish using —

- (a) a firearm; or
- (b) a jag hook unless the jag hook is attached to a lure or is baited.

Penalty: a fine of \$2 000.

*[Regulation 64CA inserted in Gazette 30 May 2014 p. 1717.]*

**64C. Fishing lines in use for recreational fishing must be attended**

- (1) A person who fishes using a line must attend that line.  
Penalty: \$2 000.
- (2) Subregulation (1) does not apply to or in relation to a person fishing for a commercial purpose in accordance with an authorisation.

*[Regulation 64C inserted in Gazette 1 Oct 2003 p. 4304.]*

**64D. Nets, determining length, depth and mesh of**

- (1) For the purposes of these regulations —
  - (a) the length of a fishing net is determined by measuring the net along the cork line on which the net is hung; and
  - (b) the depth of a fishing net is determined by counting the number of meshes between opposite points on the cork and lead lines; and
  - (c) subject to subregulation (3), the size of the mesh of a fishing net is determined by measuring from knot to knot on the inside of the mesh when lightly stretched so that the opposite knots on the alternate corners are in contact.
- (2) If there is any dispute in relation to the determination of the size of the mesh of a fishing net, a 225 g weight is to be attached to one knot of the mesh to be measured and the space between that and the opposite knot measured.
- (3) If the fishing net is dry and is not constructed of single monofilament material, it is to be soaked in water for at least 10 minutes before the size of the mesh is determined in accordance with this regulation.

*[Regulation 64D inserted in Gazette 1 Oct 2003 p. 4305.]*

**64DA. Hauling nets for recreational fishing, use of**

- (1) A person must not fish by using a fishing net that is a hauling net in any ocean waters outside 800 m of the low water mark of any part of the State or any island within WA waters.
- (2) Subregulation (1) does not apply to a person fishing for a commercial purpose in accordance with an authorisation.  
Penalty: \$2 000.

*[Regulation 64DA inserted in Gazette 22 Dec 2005 p. 6222.]*

**64E. Lines etc. used for recreational fishing, limit on number of**

- (1) Unless otherwise specified in the Act or these regulations and subject to subregulation (2), a person must not use more than 2 rods, reels and lines or single lines held in the hand at any one time when fishing.
- (2) Subregulation (1) does not apply to —
  - (a) the holder of a commercial fishing licence; or
  - (b) a person fishing from a boat.
- (3) A person, other than the holder of a commercial fishing licence, when fishing WA waters may not use a line with more than 3 baits or lures attached.  
Penalty: \$2 000.

*[Regulation 64E inserted in Gazette 1 Oct 2003 p. 4305-6; amended in Gazette 27 Aug 2013 p. 4056.]*

**64F. Fishing nets, general requirements for**

- (1) A person must not fish by means of using a fishing net, unless the person uses only one net at any one time and —
  - (a) where the net is a throw net, it —
    - (i) has a length not exceeding 3 m measured from the centre retrieval line to the lead line; and
    - (ii) has a mesh of not more than 25 mm;

**Fish Resources Management Regulations 1995**

**Part 4A** Requirements regarding fishing gear

**Division 2** Statewide requirements regarding fishing gear

**r. 64F**

---

or

- (b) where the fishing net is not a throw net, it —
  - (i) has a length not exceeding 60 m; and
  - (ii) is not more than 25 meshes in depth; and
  - (iii) does not have a bag or pocket; and
  - (iv) has end floats with a diameter of not less than 150 mm on each of which is marked, in legible characters not less than 60 mm high and 10 mm wide, the gear identification number of that person; and
  - (v) has a mesh in accordance with subregulation (2); and
  - (vi) where the fishing net is a haul net —
    - (I) does not have attached to it a rope exceeding 25 m in length; and
    - (II) is not hauled other than by hand;and
  - (vii) where the fishing net is a set net, has at all times one edge floating on the surface of the water in which it is set; and
  - (viii) is made of a material which is not less than 0.35 mm in diameter.
- (2) The mesh of a fishing net referred to in subregulation (1)(b)(v) is to be not less than —
  - (a) 63 mm or more than 87 mm, where the net is used in the waters of any estuary, river or inlet, or in the entrance of any of those waters; or
  - (b) 51 mm or more than 114 mm, where the net is not set in any waters other than those referred to in paragraph (a); or
  - (c) 75 mm or more than 114 mm, where the net is set in any waters other than those referred to in paragraph (a).



- (3) This regulation does not apply —
- (a) to a person using a fishing net under the authority of a commercial fishing licence or an aquaculture licence; or
  - (b) to the taking of cherabin, crab, marron, freshwater crayfish or prawn.

Penalty: \$2 000.

*[Regulation 64F inserted in Gazette 1 Oct 2003 p. 4306-7.]*

**64G. Fishing nets, minimum distance between when set**

A person must not in any waters set a fishing net within 50 m of any other fishing net that is set.

Penalty: \$1 000.

*[Regulation 64G inserted in Gazette 1 Oct 2003 p. 4307.]*

**64H. Fishing nets to be drawn so as to protect protected fish**

A person must not in any waters draw a fishing net on shore or on board a boat in such a manner that any protected fish in the net are, or may be, killed.

Penalty: \$1 000.

*[Regulation 64H inserted in Gazette 1 Oct 2003 p. 4308.]*

**64I. Net fishing by commercial fishers in same area, priority rights between**

- (1) Priority between holders of commercial fishing licences engaged in fishing by the use of fishing nets in the same area is to be determined in accordance with this regulation.

- (2) In this regulation —

*bona fide* means a licensed fishing boat marked with its licensed fishing boat number, with a fishing crew who hold commercial fishing licences;

*ground* means —

***Fish Resources Management Regulations 1995***

**Part 4A** Requirements regarding fishing gear

**Division 2** Statewide requirements regarding fishing gear

**r. 64I**

---

- (a) any portion of a beach not longer than 800 m and the waters adjacent to that beach to a distance of 800 m measured rectangularly from that beach; or
  - (b) any area of water that is 400 m square; or
  - (c) in subregulation (4), a rectangular area of water measuring 50 m out from, and at right angles to, both sides of a set net, along the length of the net.
- (3) The priority rights for using fishing nets, other than set fishing nets are —
- (a) the first turn belongs to the master of the first bona fide fishing boat to arrive on the ground with a net, which complies with the requirements of this Act, ready for shooting and hauling; and
  - (b) the next turns belong, in order of arrival on the ground, to the masters of the next bona fide fishing boats to arrive on the ground with nets, which comply with the requirements of this Act, ready for shooting and hauling; and
  - (c) during a particular master's turn, the master has —
    - (i) exclusive right to fish the ground as long as a fishing net is ready to be shot; and
    - (ii) the right to use more than one fishing net where a school of fish is being shot;and
  - (d) a turn ends when —
    - (i) the net, or nets, have been shot and hauled or, in the case of a ground that includes a beach, hauled ashore; or
    - (ii) the master whose turn it was leaves the ground; or
    - (iii) 12 hours have elapsed since the time the master next in turn arrived on the ground, or where the ground includes a beach, 24 hours have elapsed

since the time the master next in turn arrived on the ground;

and

- (e) a master is not to have a second turn until all other masters on the ground have had a first turn.
- (4) The priority rights for using set fishing nets are —
- (a) the first turn belongs to the master of the first bona fide fishing boat to arrive on the ground with a net which complies with the requirements of this Act, ready to set; and
  - (b) the next turns belong, in order of arrival on the ground, to the masters of the next bona fide fishing boats to arrive on the ground with nets which comply with the requirements of this Act, ready to set; and
  - (c) during a particular master's turn, the master has —
    - (i) exclusive right to fish the ground as long as a fishing net is ready to be set; and
    - (ii) the right to use more than one set fishing net;and
  - (d) a turn ends when —
    - (i) the net, or nets, have been set and hauled; or
    - (ii) the master whose turn it was leaves the ground without setting a fishing net; or
    - (iii) 24 hours have elapsed since the time the master next in turn arrived on the ground;and
  - (e) a master is not to have a second turn until all other masters on the ground have had a first turn.
- (5) While a person is having a turn under this regulation, another person must not —
- (a) wilfully disturb or frighten fish on, or in the vicinity of, the ground; or

**Fish Resources Management Regulations 1995**

**Part 4A** Requirements regarding fishing gear

**Division 2** Statewide requirements regarding fishing gear

**r. 64J**

---

- (b) obstruct the person having a turn; or
- (c) set or place fishing nets so as to prevent fish getting to the ground.

Penalty: \$2 000.

- (6) The holder of a commercial fishing licence who suffers loss due to a contravention of this regulation may, with the written approval of the Minister, take legal proceedings at that person's own expense.

*[Regulation 64I inserted in Gazette 1 Oct 2003 p. 4308-11.]*

**64J. Fishing nets for recreational fishing, use of**

A person, other than the holder of a commercial fishing licence, must not —

- (a) set a fishing net in any ocean waters outside 800 m of the low water mark of any part of the State or any island within WA waters; or
- (b) use a metal stake in connection with the setting of a fishing net; or
- (c) leave a stake which was used in connection with the setting of a fishing net after the net is retrieved; or
- (d) in the waters lying south of a line drawn from Cape Inscription on Dirk Hartog Island due east to the mainland —
  - (i) use any stake in connection with the setting of a fishing net; or
  - (ii) set or leave a set fishing net within the period beginning 1½ hours after sunrise and ending 1½ hours before sunset on any one day.

Penalty: \$2 000.

*[Regulation 64J inserted in Gazette 1 Oct 2003 p. 4311; amended in Gazette 30 May 2014 p. 1717.]*

**64K. Hauling nets not to be used for recreational fishing in estuaries etc.**

A person, other than the holder of a commercial fishing licence, must not use a fishing net that is a hauling net in the waters of any estuary, river or inlet or in the entrance to any of those waters.

Penalty: \$2 000.

*[Regulation 64K inserted in Gazette 1 Oct 2003 p. 4311-12.]*

**64L. Crabs, permitted ways to fish for by recreational fishers**

- (1) A person, other than the holder of a commercial fishing licence, must not fish for crabs other than —
  - (a) by hand; or
  - (b) by using not more than 10 complying drop nets; or
  - (c) by using a hand scoop net that complies with subregulation (3); or
  - (d) by using a wire hook which is not capable of piercing a crab and is held in the hand.
- (2) The master of a boat which is not a licensed fishing boat must not use, cause or permit to be carried on the boat, more than 10 drop nets in any one day.
- (3A) The master of a boat which is not a licensed fishing boat must not use, or cause or permit to be carried on the boat, a drop net that is not a complying drop net.
- (3) A hand scoop net must —
  - (a) be generally hemispherical; and
  - (b) be hollow; and
  - (c) have a circular top rim with an internal diameter not exceeding 375 mm; and
  - (d) have a maximum internal depth measured from the plane of that rim not exceeding 210 mm; and

**Fish Resources Management Regulations 1995**

**Part 4A** Requirements regarding fishing gear

**Division 3** Requirements regarding fishing gear in the West Coast Region

**r. 64M**

---

- (e) be constructed of material that is —
  - (i) inflexible; and
  - (ii) not capable of ensnaring or entangling a crab.

Penalty: \$1 000.

*[Regulation 64L inserted in Gazette 1 Oct 2003 p. 4312;  
amended in Gazette 6 Nov 2009 p. 4471.]*

**Division 3 — Requirements regarding fishing gear in the West Coast Region**

*[Heading inserted in Gazette 1 Oct 2003 p. 4313.]*

**64M. Term used: attend**

In this Division —

**attend**, in respect of a net, means to be within 100 m of the net.

*[Regulation 64M inserted in Gazette 1 Oct 2003 p. 4313.]*

**64N. Application of this Division**

Except as stated in regulation 64OAA, this Division does not apply to a person fishing for a commercial purpose in accordance with an authorisation.

*[Regulation 64N inserted in Gazette 1 Oct 2003 p. 4313;  
amended in Gazette 8 Dec 2009 p. 4995.]*

**64NA. Prawn hand trawl nets not to be used in certain places**

A person must not use, or leave unattended, a prawn hand trawl net in the waters of —

- (a) the Harvey Estuary and its tributaries; or
- (b) the Peel Inlet and its tributaries; or
- (c) the Channel Entrance to the Peel Inlet; or
- (d) the Dawesville Cut.

Penalty: \$2 000.

*[Regulation 64NA inserted in Gazette 6 Jul 2007 p. 3388.]*

**64O. Set fishing nets, use of**

- (1) A person must not set a fishing net in any waters of the West Coast Region other than in the waters of —
  - (a) the Peel Inlet and Harvey Estuary; or
  - (b) the Leschenault Estuary; or
  - (c) the Hardy Inlet.
  
- (2) A person who fishes using a set fishing net in the West Coast Region must —
  - (a) attend that net; and
  - (b) remove the net from the water and clear it of fish at intervals of not more than one hour; and
  - (c) not set the net —
    - (i) in the waters referred to in subregulation (1)(a) — except within the period beginning at 4.30 p.m. and ending at midnight on any Wednesday; and
    - (ii) in the waters referred to in subregulation (1)(b) or (c) — within the period beginning 1½ hours after sunrise and ending 1½ hours before sunset on any one day.

Penalty: \$2 000.

*[Regulation 64O inserted in Gazette 1 Oct 2003 p. 4313; amended in Gazette 20 Dec 2011 p. 5375.]*

**64OAA. Release weight to be on boat used to fish for demersal scalefish**

- (1) In this regulation —

*demersal scalefish* has the meaning given in regulation 45(1);  
*release weight* means a weight that —

  - (a) for the purpose of returning to the seabed a live fish that has been taken, is able to be attached to the fish; and

**Fish Resources Management Regulations 1995**

**Part 4A** Requirements regarding fishing gear

**Division 3A** Requirements regarding fishing gear in the Pilbara and Kimberley Region

**r. 64OA**

---

- (b) is able to be detached from the fish when it reaches the seabed;

***West Coast Demersal Scalefish (Interim) Managed Fishery*** means the fishery declared under the *West Coast Demersal Scalefish (Interim) Management Plan 2007*.

- (2) If a person is fishing from a fishing boat under the authority conferred by an interim managed fishery permit that applies to the West Coast Demersal Scalefish (Interim) Managed Fishery, the master of the boat must ensure that there is a release weight on the boat.

Penalty: \$2 000.

- (3) If a person is fishing for demersal scalefish from a boat, other than a fishing boat, in the West Coast Region by means of a line, the master of the boat must ensure that there is a release weight on the boat.

Penalty: \$2 000.

*[Regulation 64OAA inserted in Gazette 8 Dec 2009 p. 4995; amended in Gazette 1 Mar 2011 p. 671.]*

**Division 3A — Requirements regarding fishing gear in the Pilbara and Kimberley Region**

*[Heading inserted in Gazette 22 Dec 2005 p. 6222.]*

**64OA. Application of this Division**

This Division does not apply to a person fishing for a commercial purpose in accordance with an authorisation.

*[Regulation 64OA inserted in Gazette 22 Dec 2005 p. 6222.]*

**64OB. Haul and set nets, restrictions on use of**

- (1) A person must not fish in any waters of the Pilbara and Kimberley Region using —

- (a) a haul net; or



(b) a set net.

Penalty: a fine of \$2 000.

- (2) Subregulation (1)(a) does not apply if the person —
- (a) is fishing in Dampier Archipelago waters; and
  - (b) is using a haul net that does not exceed 30 m in length; and
  - (c) does not take any fish except mullet.

(3) In this regulation —

***Dampier Archipelago waters*** means the waters of the Indian Ocean bounded by a line commencing at the high water mark at the northernmost point of Cape Preston, from there north to the intersection of the 200 m isobath, from there generally north-easterly along the 200 m isobath to the intersection of 117° 10' east longitude, from there south to the intersection of the high water mark on the mainland (Cape Lambert), and from there in a generally south-westerly direction along the high water mark on the mainland back to the commencement point.

*[Regulation 640B inserted in Gazette 22 Dec 2005 p. 6222-3; amended in Gazette 7 Mar 2006 p. 975; 22 Jun 2012 p. 2779.]*

### **Division 3B — Requirements regarding fishing gear in the South Coast Region**

*[Heading inserted in Gazette 22 Dec 2005 p. 6223.]*

#### **640C. Application of this Division**

This Division does not apply to a person fishing for a commercial purpose in accordance with an authorisation.

*[Regulation 640C inserted in Gazette 22 Dec 2005 p. 6223.]*

#### **640D. Set fishing nets, use of**

- (1) A person must not set a fishing net in any waters of the South Coast Region other than —

**Fish Resources Management Regulations 1995**

**Part 4A** Requirements regarding fishing gear

**Division 3B** Requirements regarding fishing gear in the South Coast Region

**r. 64OE**

---

- (a) in the waters of Wilson Inlet, Beaufort Inlet, Wellstead Inlet, Gordon Inlet, Hamersley Inlet, Pallinup River, Thomas River or Princess Royal Harbour; or
  - (b) during May — October, in the waters of Broke Inlet, Irwin Inlet, Stokes Inlet or Gairdner River.
- (2) A person who fishes using a set fishing net in the South Coast Region must not use the net —
- (a) during May — October — at any time other than between 4 p.m. and 9 p.m. on a Friday or Saturday; or
  - (b) during November — April — at any time other than between 5 p.m. and 10 p.m. on a Friday or Saturday.
- (3) A person who fishes using a set fishing net in the South Coast Region must —
- (a) attend that net; and
  - (b) remove the net from the water and clear it of fish at intervals of not more than one hour.

- (4) In this regulation —

**May — October** means the period between 1 May and 31 October in any year;

**November — April** means the period between 1 November in any year and 30 April in the following year.

Penalty: \$2 000.

*[Regulation 64OD inserted in Gazette 22 Dec 2005 p. 6223-4.]*

**64OE. Throw nets, use of**

- (1) A person must not fish by using a fishing net that is a throw net in any ocean waters of the South Coast Region other than for the taking of bait fish.
- (2) A person fishing by using a throw net in any ocean waters of the South Coast Region must not take any fish except bait fish.

(3) Subregulations (1) and (2) do not apply to a person fishing for a commercial purpose in accordance with an authorisation.

(4) In this regulation —

**bait fish** means fish of the Family Atherinidae, Clupeidae, Engraulidae, Hemirhamphidae or Mugilidae.

Penalty: \$2 000.

*[Regulation 64OE inserted in Gazette 22 Dec 2005 p. 6224-5.]*

#### **Division 4 — Requirements regarding fishing gear in certain other areas**

*[Heading inserted in Gazette 1 Oct 2003 p. 4314.]*

##### **64P. Prawn hand trawl nets, use of in Swan River and Leschenault Estuary**

A person must not use, or leave unattended, a prawn hand trawl net in the waters of —

- (a) the Leschenault Estuary; or
- (b) the Swan River —
  - (i) within 100 m of any part of the Pelican Point Nature Reserve (Reserve No. 40891); or
  - (ii) within 100 m of any part of the Milyu Nature Reserve (Reserve No. 33803).

Penalty: \$2 000.

*[Regulation 64P inserted in Gazette 1 Oct 2003 p. 4314.]*

##### **64Q. Fishing nets, use of etc. by commercial fishers in certain areas**

A person who holds a commercial fishing licence must not use, or leave unattended, in the waters of a fishery listed in the Table to this regulation —

- (a) any surface fishing net, unless the net has end floats at least 150 mm in diameter clearly marked with the

**Fish Resources Management Regulations 1995**

**Part 4A** Requirements regarding fishing gear

**Division 4** Requirements regarding fishing gear in certain other areas

**r. 64Q**

---

licensed fishing boat number of any boat used in connection with the net; or

- (b) any fishing net, unless the net has —
- (i) every tenth lead weight marked clearly with lettering at least 4 mm high showing the licensed fishing boat number referred to in paragraph (a); or
  - (ii) every tenth net float marked clearly with lettering at least 10 mm high showing the licensed fishing boat number referred to in paragraph (a).

Penalty: \$2 000.

**Table**

1. Hardy Inlet Estuarine Fishery, being the commercial fishing by fishing nets for all fish in the waters of Hardy Inlet and its tributaries.
2. West Coast Estuarine Fishery identified in the *West Coast Estuarine Fishery (Interim) Management Plan 2003*.
3. Shark Bay Beach Seine and Mesh Net Managed Fishery.
4. South Coast Estuarine Fishery, being the commercial fishing by fishing net for all fish in the waters of all estuaries on the south coast of the State between Cape Beaufort and the 129° meridian of longitude, including Princess Royal Harbour and Oyster Harbour.
5. Swan/Canning Estuarine Fishery, being the commercial fishing by fishing net for all fish in the waters of the Swan River and Canning River.
6. Lake Argyle Fishery, being the commercial fishing by fishing net for fish in the waters of Lake Argyle.

*[Regulation 64Q inserted in Gazette 1 Oct 2003 p. 4314-15; amended in Gazette 6 Jul 2007 p. 3388.]*

*[64R. Deleted in Gazette 31 Oct 2003 p. 4561.]*

**64S. Certain fishing gear not to be possessed near certain rivers and dams**

- (1) A person referred to in subregulation (2) must not be in possession of anything capable of taking fish other than —
- (a) a single marron scoop net or a single marron pole snare or not more than 6 marron drop nets; and
  - (b) no more than 5 rods, reels and lines or a single hand-held line; and
  - (c) a landing net, in accordance with regulation 64T.

Penalty: For a first offence \$5 000 or, for a second or subsequent offence, \$10 000.

- (2) Subregulation (1) applies to a person who is in or on, or within 50 m of, the waters of —
- (a) Capel River, including its tributaries; or
  - (b) Preston River, including its tributaries; or
  - (ca) the Collie River —
    - (i) upstream of the Australind Bypass Road and downstream of the Wellington Dam wall; and
    - (ii) upstream of the Mungalup Road Bridge;
- or
- (c) the Blackwood River upstream of the Alexandra Bridge, the Donnelly River or the Warren River, including the tributaries flowing into those waters; or
  - (d) Hutt River, Moore River and Murray River, upstream of the Pinjarra Weir, including the tributaries flowing into those waters; or
  - (e) Deep River, including its tributaries; or
  - (f) Gardner River, including its tributaries.
- (3) A person referred to in subregulation (4) must not be in possession of anything capable of taking fish other than —
- (a) a single marron pole snare; and

**Fish Resources Management Regulations 1995**

**Part 4A** Requirements regarding fishing gear

**Division 4** Requirements regarding fishing gear in certain other areas

**r. 64S**

---

- (b) no more than 5 rods, reels and lines or a single hand-held line; and
- (c) a landing net, in accordance with regulation 64T.

Penalty: For a first offence \$5 000 or, for a second or subsequent offence, \$10 000.

- (4) Subregulation (3) applies to a person who is in or on, or within 50 m of, the waters —

*[(a)-(c) deleted]*

- (d) of Harvey Dam and the Harvey River upstream of the South Western Highway, including the tributaries flowing into those waters; or
- (e) upstream of the Wellington Dam wall, including the tributaries flowing into those waters but not including the waters of the Collie River upstream of the Mungalup Road Bridge; or

*[(f) deleted]*

- (g) of the Margaret River, including its tributaries but not including —
  - (i) the waters of the Margaret River within the area that begins 300 m upstream of the Bussell Highway Bridge and ends 50 m downstream of that bridge; or
  - (ii) the waters of the Margaret River upstream of the Ten Mile Brook junction; or
  - (iii) the tributaries flowing into the part of the river described in subparagraph (ii);

or

- (h) of Big Brook Dam, Drakes Brook Dam, Glen Mervyn Dam, Logue Brook Dam and Lake Navarino (Waroona Dam).

*[Regulation 64S inserted in Gazette 1 Oct 2003 p. 4316-18; amended in Gazette 29 Dec 2006 p. 5891; 13 Oct 2009 p. 4033-4; 2 Nov 2011 p. 4624.]*

**64T. Landing nets, use of in certain rivers and dams**

A person is not to use a landing net in any of the waters referred to in regulation 64S(2) or (4) unless the net —

- (a) has a handle that is not more than 500 mm in length; and
- (b) is used only for the purpose of landing teleost fish taken by means of a single rod, reel and line or a single hand-held line.

Penalty: For a first offence \$5 000 or, for a second or subsequent offence, \$10 000.

*[Regulation 64T inserted in Gazette 1 Oct 2003 p. 4318; amended in Gazette 13 Oct 2009 p. 4034.]*

*[64U. Deleted in Gazette 29 Dec 2006 p. 5891.]*

## **Part 4B — Bag limits**

*[Heading inserted in Gazette 1 Oct 2003 p. 4319.]*

### **Division 1 — Preliminary**

*[Heading inserted in Gazette 1 Oct 2003 p. 4319.]*

**[64V.] Deleted in Gazette 29 Jan 2013 p. 308.]**

#### **64W. Defences prescribed (Act s. 50(3))**

It is a defence in proceedings for an offence against section 50(3) of the Act —

- (a) for the person charged to prove that the person was acting in accordance with an authority to fish for fish for scientific purposes issued under regulation 178; or
  - (b) where the person is charged with bringing onto land on any one day more fish than the bag limit of those fish, for the person to prove that he or she —
    - (i) was in possession of the fish in accordance with regulation 16D(1); and
    - (ii) was bringing those fish onto land;
- or
- (c) for a person charged with bringing onto land on any one day more fish than the bag limit of those fish to prove that regulation 16E(3A) or (3B) applied in respect of the fish immediately before the fish were brought onto land.

*[Regulation 64W inserted in Gazette 1 Oct 2003 p. 4319; amended in Gazette 4 Nov 2005 p. 5311-12; 1 Mar 2011 p. 671.]*

#### **64X. Bag limits, application of**

- (1) A person must not —
  - (a) take more fish than the bag limit prescribed for a region or other area of the State in that region or area; or



- (b) bring onto land in a region or other area of the State more fish than the bag limit prescribed for that region or area; or
  - (c) bring into any WA waters in a region or other area of the State more fish than the bag limit prescribed for that region or area.
- (2) A reference in subregulation (1) to a region or other area of the State includes a reference to the whole State.
  - (3) Except as otherwise stated, a bag limit provided for in Division 2 is prescribed for all land in the State and all WA waters.

*[Regulation 64X inserted in Gazette 1 Oct 2003 p. 4320; amended in Gazette 28 Jun 2013 p. 2890-1.]*

### **Division 2 — Bag limits**

*[Heading inserted in Gazette 29 Jan 2013 p. 308.]*

*[64Y- 64ZAA. Deleted in Gazette 29 Jan 2013 p. 308.]*

#### **65A. Bag limits for demersal finfish (regions other than West Coast region)**

- (1) For the purposes of section 50 of the Act, the quantity of fish specified in column 2 of Schedule 3 Part 1 Division 1 directly opposite a species of fish specified in column 1 of that Division (***demersal finfish***) is the bag limit in respect of fish of that species in the South Coast, Gascoyne and North Coast regions.
- (2) For the purposes of section 50 of the Act, the quantity of fish specified under the heading commencing “Grouped bag limit” in Schedule 3 Part 1 Division 1 is the bag limit in respect of all species of fish specified in that Division in the South Coast, Gascoyne and North Coast regions.

*[Regulation 65A inserted in Gazette 29 Jan 2013 p. 308-9.]*

**65B. Bag limits for demersal finfish (West Coast region)**

- (1) For the purposes of section 50 of the Act, the quantity of fish specified in column 2 of Schedule 3 Part 1 Division 2 directly opposite a species of fish specified in column 1 of that Division (*demersal finfish*) is the bag limit in respect of fish of that species in the West Coast region.
- (2) For the purposes of section 50 of the Act, the quantity of fish specified under the heading commencing “Grouped bag limit” in Schedule 3 Part 1 Division 2 is the bag limit in respect of all species of fish specified in that Division in the West Coast region.

*[Regulation 65B inserted in Gazette 29 Jan 2013 p. 309.]*

**65C. Bag limits for large pelagic finfish**

- (1) For the purposes of section 50 of the Act, the quantity of fish specified in column 2 of Schedule 3 Part 2 directly opposite a species of fish specified in column 1 of that Part (*large pelagic finfish*) is the bag limit in respect of fish of that species.
- (2) For the purposes of section 50 of the Act, the quantity of fish specified under the heading commencing “Grouped bag limit” in Schedule 3 Part 2 is the bag limit in respect of all species of fish specified in that Part.

*[Regulation 65C inserted in Gazette 29 Jan 2013 p. 309-10.]*

**65D. Bag limits for nearshore or estuarine finfish**

- (1) For the purposes of section 50 of the Act, the quantity of fish specified in column 2 of Schedule 3 Part 3 directly opposite a species of fish specified in column 1 of that Part (*nearshore or estuarine finfish*) is the bag limit in respect of fish of that species.
- (2) For the purposes of section 50 of the Act, the quantity of fish specified under the heading commencing “Grouped bag limit”

in Schedule 3 Part 3 is the bag limit in respect of all species of fish specified in that Part.

*[Regulation 65D inserted in Gazette 29 Jan 2013 p. 310.]*

**65E. Bag limit for freshwater finfish**

For the purposes of section 50 of the Act, the quantity of fish specified under the heading commencing “Grouped bag limit” in Schedule 3 Part 4 is the bag limit in respect of all species of fish specified in that Part (*freshwater finfish*).

*[Regulation 65E inserted in Gazette 28 Jun 2013 p. 2891.]*

**65F. Bag limits for other finfish**

(1A) In this regulation —

*finfish* does not include the following fish —

- (a) Carp, European;
- (b) Goldfish;
- (c) Perch, redfin;
- (d) fish of the genus *Oreochromis spp.* (entire genus).

(1) For the purposes of section 50 of the Act, the bag limit for Bait Fish and Hardyhead is 9 litres.

(2) For the purposes of section 50 of the Act, the bag limit in respect of all species of finfish not otherwise referred to in this Division is a grouped bag limit of 30.

*[Regulation 65F inserted in Gazette 29 Jan 2013 p. 310; amended in Gazette 28 Jun 2013 p. 2891-2.]*

**65G. Bag limits for crustaceans**

For the purposes of section 50 of the Act, the quantity of crustaceans specified in column 2 of Schedule 3 Part 5 directly opposite a species, or group of species, of crustaceans specified

**Fish Resources Management Regulations 1995**

**Part 4B** Bag limits

**Division 2** Bag limits

**r. 65H**

---

in column 1 of that Part is the bag limit in respect of crustaceans of that species or group of species.

*[Regulation 65G inserted in Gazette 29 Jan 2013 p. 310; amended in Gazette 28 Jun 2013 p. 2892.]*

**65H. Bag limits for molluscs and other invertebrates**

For the purposes of section 50 of the Act, the quantity of molluscs or invertebrates specified in column 2 of Schedule 3 Part 6 directly opposite a species, or group of species, of molluscs or invertebrates specified in column 1 of that Part is the bag limit in respect of molluscs or invertebrates of that species or group of species.

*[Regulation 65H inserted as regulation 66H in Gazette 29 Jan 2013 p. 311; renumbered as regulation 65H in Gazette 18 Jun 2013 p. 2296; amended in Gazette 28 Jun 2013 p. 2892.]*

*[Division 3 deleted in Gazette 29 Jan 2013 p. 311.]*

*[Division 4 deleted in Gazette 3 Feb 2009 p. 227.]*

## **Part 5 — Fish processing**

### **65. Classes of fish prescribed (Act s. 82(2)(a))**

For the purposes of section 82(2)(a) of the Act fish of a prescribed class are —

- (a) rock lobsters; and
- (b) prawns; and
- (c) scallops.

### **66. Fish processor's licences, conditions of**

A fish processor's licence is subject to the following conditions —

- (a) the holder of the licence —
  - (i) must not receive or purchase marron;
  - (ii) must ensure that marron is not brought onto the place specified in the licence as the place at which the fish are to be processed under the licence,

unless the licence authorises the processing of marron and the marron are sold by the holder of an aquaculture licence and the consignment note referred to in regulation 69(c) is securely attached to the marron or to the receptacle, container or package containing the marron;

- (b) the holder of the licence is to ensure that a consignment note referred to in paragraph (a) is retained at the place at which fish are to be processed under the licence;
- (c) the holder of the licence must not purchase fish (other than fish lawfully taken outside WA waters) to process from any person other than the holder of a commercial fishing licence, a fish processor's licence, or an aquaculture licence;

- (d) the holder of the licence must notify the CEO in writing within 24 hours of becoming aware, or suspecting, that any fish at the place where fish processing is carried on under the licence is or may be affected by —
  - (i) any scheduled fish disease; or
  - (ii) any disease or condition that the person cannot identify;
- (e) the holder of the licence must notify the CEO in writing within 14 days of becoming aware, or suspecting, that any fish at the place where fish processing is carried on under the licence is or may be affected by any disease or condition other than one referred to in paragraph (d) if, within those 14 days, the holder of the licence has not eradicated the disease or condition by taking all reasonable steps to do so;
- (f) the holder of the licence must take all reasonable precautions to prevent the spread of any disease or condition in fish at the place where fish processing is carried on under the licence;
- (g) where the holder of the licence is aware or suspects that fish at the place where fish processing is carried on under the licence are affected by any disease or condition, that person must ensure that no water is discharged from the place to a natural waterway without the prior written approval of the CEO;
- (h) the holder of the licence must cause to be kept, at the place specified in the licence as the place at which fish may be processed under the licence, written records of all fish processed at the place and of the business carried on at that place.

*[Regulation 66 amended in Gazette 6 Jul 2007 p. 3389;  
24 Sep 2013 p. 4438.]*

## Part 6 — Aquaculture

### 67. Aquaculture leases, application for

- (1) An application for the grant or renewal of an aquaculture lease must be —
  - (a) made to the Minister in a form approved for that purpose by the CEO; and
  - (b) accompanied by the fee set out in item 10 of Part 2 of Schedule 1; and
  - (c) accompanied by any information that the Minister reasonably requires for a proper consideration of the application.
- (2) An applicant must provide the Minister with any further information that the Minister by notice in writing requires the applicant to provide in respect of an application.
- (3) An applicant must, if required to do so by the Minister, verify by statutory declaration any information contained in, or given in connection with, an application.
- (4) The Minister may refuse to consider an application if the application does not conform to a provision of this regulation or if the applicant has failed to comply with a provision of this regulation.

*[Regulation 67 amended in Gazette 6 Jul 2007 p. 3389.]*

### 68. Classes of fish etc. prescribed (Act s. 91(a) and (d))

- (1) Fish of the following specified classes for the following specified purposes or areas are prescribed for the purpose of section 91(a) of the Act —
  - (a) all fish in respect of all non-commercial purposes; and
  - (b) all fish, excluding marron, in respect of display or ornamental hobby purposes; and

**r. 69A**

---

- (c) all fish in respect of display or ornamental purposes in retail establishments; and
  - (d) all fish in respect of displaying the fish in a public aquarium or oceanarium.
- (2) The following are prescribed for the purposes of section 91(d) of the Act in relation to a dam or lake on private land —
- (a) in the area described in Schedule 6 — yabbie (common and white), koonac and gilgie; and
  - (b) in any area of the State — black bream.

*[Regulation 68 amended in Gazette 25 Sep 1998 p. 5299.]*

**69A. Classes of fish prescribed (Act s. 92A(4))**

- (1) In this regulation —
- live import list** means the list of specimens that are to be taken to be suitable for live import established under the *Environmental Protection and Biodiversity Conservation Act 1999* (Commonwealth) section 303EB as amended from time to time;
- ornamental fish** means fish of a species that is —
- (a) included in the live import list Part 1 or Part 2; and
  - (b) not referred to in Schedule 3.
- (2) For the purposes of section 92A(4) of the Act the fish referred to in the Table are prescribed fish.

**Table**

Barramundi
Bream, Black
Clams of species <i>Tridacna derasa</i>
Clams of species <i>Tridacna maxima</i>



---

Cod, Murray
Gilgie
Koonac
Marron
Ornamental fish
Perch, Golden
Perch, Silver
Trout, Brown
Trout, Rainbow
Yabbie, Common
Yabbie, White

*[Regulation 69A inserted in Gazette 30 May 2014 p. 1717-18.]*

**69. Aquaculture licences, conditions of**

An aquaculture licence is subject to the following conditions —

- (a) the holder of the licence must ensure that fish is not sold under the authority of the licence unless it is packed in the manner specified by the CEO; and
- (b) where marron is sold on a retail basis, the holder of the licence who is selling the marron, must provide to the purchaser a receipt specifying —
  - (i) the names of the holder of the licence and the purchaser; and
  - (ii) the number and type of fish; and
  - (iii) the value and date of the sale;

and

- (c) where marron is sold on other than a retail basis, the holder of the licence who is selling the marron, must prepare a consignment note in triplicate in a form approved by the CEO and must —
  - (i) securely attach the original of the consignment note to the marron or to the receptacle, container or package containing the fish; and
  - (ii) send the duplicate copy of the consignment note —
    - (I) to the head office of the Department at Perth; or
    - (II) if another office of the Department is specified in the approved form of the consignment note, to that office,

to arrive —

- (III) within 7 days after the sale; or
- (IV) if a greater period is specified in the approved form, within that period;

and

- (iii) retain the triplicate copy at the place where aquaculture is carried out under the licence;

and

- (d) the holder of the licence must notify the CEO in writing within 24 hours of becoming aware, or suspecting, that any fish at the place where aquaculture is carried on under the licence is or may be affected by —
  - (i) any scheduled fish disease; or
  - (ii) any disease or condition that the person cannot identify;

and

- (e) the holder of the licence must notify the CEO in writing within 14 days of becoming aware, or suspecting, that any fish at the place where aquaculture is carried on under the licence is or may be affected by any disease or condition other than one referred to in paragraph (d) if, within those 14 days, the holder of the licence has not eradicated the disease or condition by taking all reasonable steps to do so; and
- (f) the holder of the licence must take all reasonable precautions to prevent the spread of any disease or condition in fish at the place where aquaculture is carried on under the licence; and
- (g) where the holder of the licence is aware or suspects that fish at the place where aquaculture is carried on under the licence are affected by any disease or condition, that person must ensure that no water is discharged from the place to a natural waterway without the prior written approval of the CEO; and
- (h) the holder of the licence must ensure that fish at the place where aquaculture is carried on under the licence which the holder of the licence is aware, or suspects, is diseased or contaminated is not removed from the place without the prior written permission of the CEO.

*[Regulation 69 amended in Gazette 13 Aug 1999 p. 3826; 6 Jul 2007 p. 3389; 24 Sep 2013 p. 4438.]*

## **Part 7 — Noxious fish**

### **70.        Species prescribed (Sch. 5 and Act s. 103)**

The species of fish described by a scientific name listed in Schedule 5 column 1 are prescribed under section 103 of the Act to be noxious fish in the area described in Schedule 5 column 3 for the purposes of the Act.

*[Regulation 70 inserted in Gazette 22 Oct 2014 p. 4088.]*

## **Part 8 — Designated fishing zones**

### **71. Fisheries officer may restrict activities etc. in zones**

- (1) A fisheries officer may, by notice in writing given to a person, prohibit the person from —
  - (a) being in a designated fishing zone for a specified period of time, or at all; or
  - (b) engaging in a specified activity in a designated fishing zone; or
  - (c) having a specified thing or class of things in a designated fishing zone.
- (2) A fisheries officer may by further notice in writing given to a person vary or revoke a notice given under subregulation (1).
- (3) A person who contravenes a notice in writing given by a fisheries officer under this regulation commits an offence.  
Penalty: \$10 000.

## **Part 9 — Abrolhos Islands reserve**

### **Division 1 — Interpretation and application of Part**

#### **72. Terms used**

In this Part, unless the contrary intention appears —

***approved*** means approved by the CEO;

***associated camp*** means a camp, including any associated jetty, in the reserve which is allocated to an operator by virtue of a rock lobster licence;

***camp*** includes all structures on or adjoining any island or on a jetty in the reserve which are associated with a rock lobster licence;

***jetty*** means a jetty which is attached to and leads onto land within the reserve or is situated within waters adjacent to the reserve;

***licensed boat*** means a boat operated under a rock lobster licence;

***mooring*** means any gear (including an anchor or stake) set out on the seabed in a permanent manner to which a boat or other floating structure may be secured by a chain, cable, wire or rope;

***operator*** means the master of a licensed boat;

***reserve*** means the Abrolhos Islands reserve;

***rock lobster licence*** means a managed fishery licence granted in respect of the West Coast Rock Lobster Managed Fishery which authorises fishing for rock lobster in the reserve;

***share arrangement*** means a valid written agreement to share facilities under regulation 92.

*[Regulation 72 amended in Gazette 6 Jul 2007 p. 3389;  
1 Mar 2013 p. 1092; 27 Aug 2013 p. 4056.]*

**73. Application of this Part**

This Part applies to and in respect to all land and waters within and adjacent to the reserve.

**Division 2 — Jetties**

**74. Construction and modification of jetties and moorings**

- (1) A person who wishes to construct or modify a jetty or mooring must first apply to the CEO in the approved form.
- (2) If the CEO gives approval following an application under subregulation (1), that approval may be subject to such conditions as the CEO considers are necessary in the particular case and endorses on the approval.
- (3) A person referred to in subregulation (1) must not commence construction or modification of a jetty or mooring unless the written approval of the CEO has been obtained.
- (4) A person must comply with a condition endorsed on an approval given under this regulation.

Penalty for an offence under subregulation (3) or (4): Not less than \$500 or more than \$2 000.

- (5) A fisheries officer may, by notice in writing given to a person to whom approval was granted under this regulation, order that work specified in the notice be carried out within the time specified in the notice on a jetty or mooring that the fisheries officer believes is insecure or unsafe.
- (6) A person must comply with an order given under subregulation (5) within the time specified in the order.

Penalty: \$1 000.

*[Regulation 74 amended in Gazette 6 Jul 2007 p. 3389.]*

**75. Unauthorised use of jetties and moorings**

- (1) A person, other than —
  - (a) the owner of; or

- (b) a person who is a party to a share arrangement in relation to; or
- (c) the person responsible for,

a jetty or mooring, must not use that jetty or mooring without the written permission, in the approved manner, of a person set out in paragraph (a), (b) or (c).

Penalty: Not less than \$100 or more than \$1 000.

- (2) Where written permission has been obtained in accordance with subregulation (1) —
  - (a) a copy of the written permission must be filed with the Geraldton or Dongara office of the Department before the jetty or mooring is used by the person obtaining that permission; and
  - (b) a copy of the written permission must be retained on board the appropriate boat and presented to a fisheries officer on demand.
- (3) Subject to subregulations (1) and (2), a person must not cause a boat, other than a licensed boat or an approved boat, to tie up to a jetty or mooring overnight.

Penalty: Not less than \$100 or more than \$1 000.
- (4) This regulation does not apply to —
  - (a) an emergency situation; or
  - (b) a jetty which is an approved public use jetty.

### **Division 3 — Buildings and facilities**

#### **76. CEO may waive requirements of this Division**

- (1) The CEO may waive or vary any of the requirements in this Division, on a case-by-case basis, if the circumstances are considered to be exceptional, or of sufficient public or heritage interest to do so.



- (2) Any waiver or variation must be in writing, and must specify to whom or what it applies, and under what circumstances.

*[Regulation 76 amended in Gazette 6 Jul 2007 p. 3389.]*

**77. Camps associated with rock lobster licences, transfer of etc.**

- (1) The holder of a rock lobster licence who applies to —

- (a) transfer that licence; or
- (b) redistribute an entitlement on that licence; or
- (c) acquire a further rock lobster licence and amalgamate that licence with another rock lobster licence,

must, at the same time, apply in the approved manner to either transfer or remove the associated camp (as the case requires).

- (2) If the CEO considers it appropriate, the CEO may approve an application, made under subregulation (1), to transfer or remove an associated camp, and the CEO may make that approval subject to conditions which must be endorsed on the approval.
- (3) A person who does not comply with the conditions endorsed on an approval to transfer or remove an associated camp commits an offence.

Penalty: Not less than \$100 or more than \$1 000.

- (4) A rock lobster licence holder may apply, in the approved manner, to relocate from a former camp to another associated camp.
- (5) If the CEO considers it appropriate, the CEO may approve an application, made under subregulation (4), to relocate, and the CEO may make that approval subject to conditions which must be endorsed on the approval.
- (6) A person must comply with the conditions endorsed on an approval to relocate.

Penalty: Not less than \$100 or more than \$1 000.

- (7) An operator must not operate from more than one camp at any one time during any single rock lobster season, but the crew may live aboard the boat during any period away from the camp.

Penalty: Not less than \$100 or more than \$1 000.

*[Regulation 77 amended in Gazette 14 Nov 2001 p. 5978;  
6 Jul 2007 p. 3389.]*

**78. Camp not transferred etc. under r. 77 becomes unauthorised structure**

- (1) Where a person —
- (a) does not comply with the conditions endorsed on an approval under regulation 77(2); or
  - (b) purports to transfer a camp without the approval of the CEO,

the camp is an unauthorised structure for the purposes of Division 5.

- (2) An amount determined by the CEO from time to time must be paid by the owner of the camp prior to an application for —
- (a) a transfer, a redistribution of an entitlement or a further acquisition referred to in regulation 77(1); or
  - (b) a relocation referred to in regulation 77(4),
- being approved and that amount must —
- (c) be returned to the owner (at the time of the application) of the camp upon compliance with the conditions of any approval issued by the CEO; or
  - (d) be used to defray the actual costs, including the administrative costs, involved in removing part or all of a camp that becomes an unauthorised structure under subregulation (1).

*[Regulation 78 amended in Gazette 14 Nov 2001 p. 5978;  
6 Jul 2007 p. 3389.]*

**79. Building standards, owners' duties as to**

- (1) The owner of a building which is to be constructed in the reserve must ensure that all work to be undertaken on that building complies with the written laws of the State relating to the control of building works.
- (2) Where, in the opinion of a fisheries officer, the owner of a building in the reserve fails to adequately maintain that building to an acceptable standard (other than a standard relating to structural soundness), the officer may order the owner to undertake, or cause to be undertaken, remedial work which —
  - (a) is sufficient to bring the building up to an acceptable standard; and
  - (b) must be completed within the time period set out in the order.
- (3) Where a fisheries officer suspects that a building in the reserve does not meet the appropriate standard relating to structural soundness, a fisheries officer may order the owner to obtain, and produce to a fisheries officer, a report from a registered builder stating whether or not that building complies with the written laws of the State relating to the minimum structural requirements for that type of building.
- (4) If a report obtained under subregulation (3) states that a building does not meet the minimum structural requirements for that type of building, a fisheries officer may order the owner to undertake, or cause to be undertaken, remedial work which —
  - (a) is sufficient in the opinion of a registered builder to bring the building up to the minimum standards; and
  - (b) must be completed within the time period set out in the order.
- (5) A person who does not comply with an order under subregulation (2), (3) or (4) commits an offence.  
Penalty: Not less than \$100 or more than \$1 000.

**80. Minor structural changes to buildings, requirements for**

- (1) The owner of a building in the reserve who wishes to make any minor structural change to the building —
  - (a) must, if required by a fisheries officer, obtain and produce a written report of a registered builder stating that the changes will be safe and structurally sound; and
  - (b) must file plans of the change, together with the report obtained under paragraph (a), with the Department; and
  - (c) must not allow work to commence until the CEO has given approval.

Penalty: Not less than \$100 or more than \$1 000.

- (2) For the purposes of this regulation, a minor structural change is a modification or alteration to the building which does not increase or modify the floor space or height of the building (including the addition of shade-cloth, pergolas, verandahs and similar weather protection), but does not include —
  - (a) re-roofing that involves re-pitching that roof; or
  - (b) internal work that involves the installation of split-level living areas or the like; or
  - (c) re-cladding of walls that increases the external dimensions or floorspace of the building.

*[Regulation 80 amended in Gazette 6 Jul 2007 p. 3389.]*

**81. New buildings and major structural changes to buildings, requirements for**

- (1) The owner of an existing building or the person proposing to construct a new building in the reserve must, prior to commencing any major change to an existing building or commencing the construction of a new building, as the case requires —
  - (a) obtain and provide full structural plans approved by a registered builder; and

- (b) endeavour to obtain the written opinions of the operators with associated camps adjacent to the building or proposed building for the consideration of the CEO prior to the CEO giving or withholding approval; and
  - (c) obtain the written approval of the CEO.
- (2) Approval under subregulation (1) is subject to such conditions that the CEO considers are necessary in the particular case.
- (3) For the purposes of subregulation (1), the requisite opinions must be obtained after each relevant operator, referred to in subregulation (1)(b), is informed of (as a minimum) the proposed common access areas, pathways, drains, power plants and other like infrastructure.
- (4) For the purposes of this regulation a major change is any modification or alteration to a building which increases or modifies the floor space or height of that building.
- (5) A new camp or a camp being set up through the transfer of camp facilities under regulation 77 made up of more than —
  - (a) 3 living dwellings; or
  - (b) one store shed; or
  - (c) one ablution block; or
  - (d) the approved number of generator sheds for that camp; or
  - (e) the approved number of jetties for that camp,(not including on-jetty storage facilities) will not be approved.
- (6) A building which is, or is being, constructed without complying with this regulation is an unauthorised structure for the purposes of Division 5, unless the CEO exempts the building, in writing, from compliance with the specific building provisions with which it does not comply.

- (7) A person must comply with the approval of the CEO obtained under subregulation (1).

Penalty: Not less than \$500 or more than \$2 000.

*[Regulation 81 amended in Gazette 15 Jan 1999 p. 113;  
6 Jul 2007 p. 3389.]*

#### **Division 4 — Power and maintenance**

*[82, 83. Deleted in Gazette 23 May 2006 p. 1860.]*

#### **84. Water tanks etc., occupiers' duties as to**

Where the water supply to any premises which is intended for human consumption is drawn, or partly drawn, from a water tank, the occupier of the premises must —

- (a) maintain the roof forming the catchment for the tank, together with the spouting and downpipes appurtenant to the roof in a clean and functional state; and
- (b) at least once a year, during the months of April and May thoroughly check any water tank, the water from which is used for human consumption for any sludge or detritus buildup, and, where necessary, clean the tank; and
- (c) ensure that every water tank on the premises containing water for human consumption is fitted with a tight fitting, light-proof, water-proof and secure cover; and
- (d) when ordered to do so by a fisheries officer, empty, cleanse and disinfect any water tank on the premises.

Penalty: \$500.

#### **85. Generators, installation and use of**

- (1) A person must, before installing a generator —
  - (a) obtain the opinion in writing of the majority of operators likely to be affected by the noise emitted by that

generator for the consideration of the CEO prior to the CEO giving or withholding approval; and

- (b) obtain the written approval of the CEO.

Penalty: \$500.

- (2) Subject to regulation 86, a person who installs a generator must ensure that the generator is sound-proofed and silenced to ensure that noise emissions do not exceed those set out in regulation 104.

Penalty: \$500.

*[Regulation 85 amended in Gazette 6 Jul 2007 p. 3389.]*

**86. Machinery noise, fisheries officer's powers as to**

- (1) Where undue noise is being emitted by any machinery, a fisheries officer may, in writing, order the owner of, or person in charge of, the machinery to undertake work to ensure that the machinery noise level is reduced so that noise emissions do not exceed those set out in regulation 104.
- (2) A person to whom an order is given under subregulation (1) must comply with that order within the time specified in that order.

Penalty: \$500.

**Division 5 — Unauthorised structures and termination of tenancy**

**87. Terms used**

In this Division —

***structure*** means any building, jetty, mooring, power plant, or any other like facility;

***unauthorised structure*** means a structure that —

- (a) has been erected without approval, abandoned, or is unsafe or is not secure, or in respect of which an order under regulation 74(5) has not been complied with

within the time specified in the order, or does not conform with this Division, or becomes an unauthorised structure as a result of the operation of regulation 78 or 81(6); and

- (b) has not been claimed by the Crown for its use or for specific community purpose use.

**88. Unauthorised structures, CEO may direct removal of**

- (1) The CEO may, by written notice served in accordance with regulation 89 and identifying the unauthorised structure to which it relates, direct a person in occupation or control of an unauthorised structure to remove it, together with its contents.
- (2) A copy of the notice referred to in subregulation (1) must be affixed (where practicable) to the unauthorised structure, and must be published —
  - (a) in the *Gazette*; and
  - (b) in one or more newspapers circulating daily in Geraldton and the Mid-West area.

*[Regulation 88 amended in Gazette 6 Jul 2007 p. 3389.]*

**89. Service of r. 88 notice**

- (1) A notice under regulation 88(1) may be served on the owner of, the occupier of or the person in control of, an unauthorised structure (or all of them, as the case may be) —
  - (a) in person; or
  - (b) by post,

in accordance with sections 75 and 76 of the *Interpretation Act 1984*.

- (2) Despite subregulation (1), where the owner, occupier or person in control of an unauthorised structure is unknown, or known to be absent from the State, the notice may be served by using the procedure in regulation 88(2), and, when the person to whom it is to be addressed is unknown, the notice may be addressed to



“the person in or in control of” the unauthorised structure (identifying it) to which the notice refers, without further name or description.

- (3) If more than one person is in apparent occupation or control of an unauthorised structure, it is sufficient to serve the notice on one of them and address it to that one with the addition of the words “and others” or “and another” as the case requires.
- (4) Non-service on the person in apparent control of the unauthorised structure does not affect the validity of service on the person in apparent occupation of the unauthorised structure, and non-service on the person in apparent occupation of the unauthorised structure does not affect the validity of service on the person in apparent control of the unauthorised structure.

**90. Non-compliance with r. 88 notice**

Where a person fails to comply with a notice under regulation 88 within a period of 2 months from the time of service, and the CEO is satisfied —

- (a) that the structure is an unauthorised structure; and
- (b) that the notice has been properly served; and
- (c) that the person has not complied with the notice within the period,

the CEO may, in writing —

- (d) authorise a fisheries officer to arrange for the removal of the unauthorised structure and its contents; or
- (e) authorise the destruction or sale of the unauthorised structure, or part of that structure, or its contents, or both the structure and its contents; or
- (f) authorise the sale of the unauthorised structure or its contents or both on condition that it or they are removed upon sale; or

- (g) authorise the recovery of costs, incurred in the removal, destruction or sale of the unauthorised structure, from the owner, occupier or person in control of that structure; or
- (h) where the unauthorised structure or its contents are offered for sale under paragraph (e) or (f) and —
  - (i) have not been sold; or
  - (ii) do not raise a sufficient amount at sale to defray the cost of removal, destruction or sale of that unauthorised structure or its contents,authorise the recovery of costs, or of the unsatisfied balance of the costs, from the person, or occupier, in control of the unauthorised structure or the owner, or both.

*[Regulation 90 amended in Gazette 6 Jul 2007 p. 3389.]*

**91. Site of unauthorised structure to be cleared completely**

A person who is directed to remove an unauthorised structure under regulation 88(1) must clear the site of residual materials and rubbish.

Penalty: \$2 000.

**Division 6 — Share arrangements and dispute procedure**

**92. Share arrangement to be subject of written agreement**

- (1) Where it is agreed between 2 or more parties to share camp facilities, jetties, moorings, power outlets or lighting plants, the parties to that agreement must sign a written agreement in the approved form, together with illustrative diagrams relating to that agreement (if appropriate).
- (2) A written agreement under subregulation (1) is not valid unless a copy of the signed, written agreement is filed with the Department.

- (3) A written agreement cannot be amended without the written approval of the CEO.

*[Regulation 92 amended in Gazette 6 Jul 2007 p. 3389.]*

**93. Disputes over use of shared buildings etc., resolution procedure for**

- (1) If a dispute arises which relates to the use of a building, structure or facility in the reserve, and which is the subject of a share arrangement, the following procedure may be used to resolve the dispute —

- (a) a party to the dispute may write to the Minister advising of the existence of the dispute and may seek invocation of the dispute procedure set out in this Division; and
- (b) where the Minister is of the opinion that it is justified, the Minister may invoke this dispute procedure and appoint an independent arbitrator to deal with the dispute.

- (2) The CEO may appoint an independent arbitrator to deal with disputes that have been running for longer than 6 months without signs of resolution.

*[Regulation 93 amended in Gazette 6 Jul 2007 p. 3389-90.]*

**94. Independent arbitrators, duties of**

- (1) An independent arbitrator must —
- (a) write to the parties known to be involved in the dispute seeking, from each of them, a written statement of the grounds of the dispute; and
  - (b) upon receipt of the grounds requested in paragraph (a), or after a reasonable time if either or both do not reply, inform each party of the known grounds of dispute.
- (2) After obtaining advice, if required, from the CEO or other relevant person, and allowing sufficient time to enable each party to put their side of the dispute, and following due

consideration, the independent arbitrator must make a determination.

*[Regulation 94 amended in Gazette 6 Jul 2007 p. 3389-90.]*

**95. Arbitrator's determination to be decided by Minister**

- (1) A determination under regulation 94(2) must be referred by the independent arbitrator to the Minister who may decide to accept or reject the determination, and who must inform the parties of the decision.
- (2) The decision of the Minister is binding upon the parties.

**Division 7 — Disposal of waste**

**96. Waste disposal to be in accordance with this Division**

- (1) A person must not dump or dispose of any waste, other than in accordance with this Division.  
Penalty: \$2 000.
- (2) A person who contravenes subregulation (1) is liable for any cost incurred if the waste is removed at the request of the CEO, in addition to the penalty specified for contravention of that subregulation.

*[Regulation 96 amended in Gazette 6 Jul 2007 p. 3389-90.]*

**97. Food waste**

- (1) A person must dispose of food waste —
  - (a) by dumping that waste at sea; or
  - (b) by incinerating the waste in an incinerator.
- (2) Where any unburnt residue remains after incineration of waste under subregulation (1), the person incinerating the waste must ensure that the residue is returned to the mainland for disposal, or disposed of at an approved dumping site.  
Penalty: \$1 000.

**98. Paper, plastic, cardboard, bait bags etc.**

- (1) A person must not dispose of paper, plastic, cardboard, bait bags, or other combustible materials by dumping them at sea.  
Penalty: \$1 000.
- (2) A person must dispose of paper, plastic, cardboard, bait bags and other combustible items of a like nature —
  - (a) by returning these items to the mainland for recycling or disposal; or
  - (b) by incinerating these items in an incinerator.
- (3) Where any unburnt residue remains after incineration under subregulation (2), the person incinerating the items must ensure that the residue is disposed of by —
  - (a) returning it to the mainland for disposal; or
  - (b) by bagging, or otherwise containing, it in non-hazardous natural and non-combustible material and dumping it at an approved refuse dumping site.  
Penalty: \$1 000.

**99. Non-hazardous and non-combustible waste**

- (1) A person may dispose of non-hazardous and non-combustible materials, including cray-pots, water tanks, household and building materials —
  - (a) by returning those materials to the mainland for recycling or disposal; or
  - (b) by dumping those materials at an approved refuse dumping site.
- (2) A person who disposes of the material referred to in subregulation (1) by dumping them in an area other than the mainland or an approved refuse disposal site commits an offence.  
Penalty: \$1 000.

**100. Oil, fuel, engine filters and batteries**

A person must not dispose of any oil, fuel, engine filter or battery other than by returning it to the mainland.

Penalty: \$2 000.

**101. Campsite waste**

- (1) The operator must provide an associated camp with fly-proof and vermin-proof waste receptacles which may be used for the disposal of putrescible material.
- (2) An operator who establishes, or is in control of an associated camp is responsible for keeping that camp, and any associated jetty or foreshore areas, free from waste.
- (3) A fisheries officer may, in writing, order the operator of a camp to remove waste from any part of a camp or adjacent foreshore areas.
- (4) An operator who does not comply with an order under subregulation (3) commits an offence and in addition to any penalty to which that operator is liable, will be liable for any cost incurred if the waste is removed at the request of the CEO.

Penalty: \$500, and a daily penalty of \$50.

*[Regulation 101 amended in Gazette 6 Jul 2007 p. 3389-90.]*

**102. Sewage**

A person must not dispose of sewage in any manner other than —

- (a) where practicable, by use of a saltwater flushing outfall pipe feeding directly into the sea; or
- (b) through a septic tank disposal system; or
- (c) by use of an approved sewage disposal system at an approved site.

Penalty: \$500.

**103. Incinerators, construction and use of**

- (1) An incinerator for the disposal of waste —
  - (a) must be constructed in a manner which allows combustion to occur in an efficient manner; and
  - (b) if constructed wholly or partly of mesh, must be made using a mesh of not more than 50 mm; and
  - (c) must be sited —
    - (i) in an area approved in writing by a fisheries officer; and
    - (ii) so that correct use does not cause smoke to become a nuisance.
- (2) An operator who uses an incinerator must ensure —
  - (a) that the incinerator is cleaned after use to avoid leaving unburnt residues to remain or smoulder; and
  - (b) that the incinerator is not used before noon, or such other time as is determined by a fisheries officer.

Penalty: \$500.

**Division 8 — Miscellaneous**

**104. Noise to be kept below certain levels**

- (1) A resident or visitor must ensure that the noise emissions from premises or motors in the reserve (other than boats), under the person's control, do not exceed the following levels —
  - (a) 50dB(A), between the hours of 6.00 a.m. and 7.00 p.m., on any day; or
  - (b) 40dB(A), between the hours of 7.00 p.m. on any day and 6.00 a.m. on the following day,and must ensure that tonal noise or impulses of noise which are unreasonably loud are not emitted.
- (2) If a fisheries officer receives a complaint alleging that a person is responsible for noise in excess of the levels set out in

subregulation (1), a fisheries officer may investigate that complaint and, if appropriate, request the person to undertake reasonable measures to lower the level of noise to comply with subregulation (1).

- (3) A person must not, without a lawful excuse, refuse to carry out a request under subregulation (2).

Penalty: \$500.

- (4) For the purposes of this regulation, ***dB(A)*** means the reading in decibels on a sound level meter or other sound level measuring equipment using the A-weighting network specified for sound level meters in Part I or Part II, whichever is applicable to the measuring equipment in question, of Australian Standard AS 1259 of 1976.

**105. Vehicles not to be used without CEO's approval**

- (1) A person must not bring a vehicle into the reserve unless the CEO has given written approval in which it is specified the conditions under which the vehicle may be in the reserve.

Penalty: \$1 000.

- (2) Conditions under subregulation (1) may include, but are not limited to, restrictions on —

- (a) the time of day that the specified vehicle may be used; and
- (b) the person or persons that are allowed to use that vehicle; and
- (c) the period for which the approval is valid; and
- (d) the purposes for which that vehicle can be used.

- (3) A person must not use a vehicle in the reserve in contravention of a condition imposed under this regulation.

Penalty: \$500.

*[Regulation 105 amended in Gazette 6 Jul 2007 p. 3389-90.]*



[105A. *Inserted in Gazette 26 Mar 1999 p. 1279-80. Disallowed in Gazette 25 Jun 1999 p. 2742.*]

**106. Domestic pets prohibited on reserve and boats at jetties**

A person must not —

- (a) keep a domestic pet in the reserve; or
- (b) allow or cause a boat with a domestic animal on board to secure to or come alongside any jetty in the reserve; or
- (c) allow or cause any domestic animal to be landed onto any island in the reserve.

Penalty: \$1 000.

**107. Flora and fauna not to be introduced without approval**

A person must not introduce any species of flora or fauna to the reserve, unless that person has first obtained the written approval of the CEO and the Department of Conservation and Land Management<sup>3</sup>.

Penalty: \$2 000.

*[Regulation 107 amended in Gazette 6 Jul 2007 p. 3389-90.]*

**108. Noxious etc. plants, pests etc., control of to be by approved methods**

- (1) When carrying out measures for noxious or introduced plant control in the reserve, a person must use only approved preventive and control methods.  
Penalty: \$250.
- (2) A person must not carry out noxious or introduced plant control in an area that has not been approved by a fisheries officer.  
Penalty: \$250.
- (3) When carrying out measures to control rodents, cockroaches, mosquitos or flies, a person must only use approved preventive and control methods.  
Penalty: \$250.

- (4) A person must not carry out any rodent or pest baiting programme in the reserve unless the person has first obtained the approval of the CEO.

Penalty: \$250.

*[Regulation 108 amended in Gazette 6 Jul 2007 p. 3389-90.]*

**109. Behaviour standards for people; power to direct person to leave**

- (1) A person, while in the reserve, must not engage in behaviour which falls short of normal community standards and a fisheries officer may direct a person to leave the reserve if, in the opinion of both a fisheries officer and a majority of residents in the area, that standard of behaviour is not maintained by that person.

- (2) A person must comply with a direction under subregulation (1) within 24 hours of that direction being given.

Penalty: \$500.

**110. Chlorine tarping of boats, restrictions on**

- (1) A person must not carry out chlorine tarping on a boat unless —
- (a) the boat is secured to a mooring or is anchored; and
  - (b) it is carried out when there are no rock lobsters in holding crates within 50 m of the boat.

Penalty: \$1 000.

- (2) In this regulation *chlorine tarping* means the enclosing of a boat's hull by a cover, such as a tarpaulin, and the adding of chlorine to the water enclosed between the boat and the cover.

*[111. Deleted in Gazette 30 May 2014 p. 1718.]*

**112. Weapons prohibited**

A person must not bring into the reserve or possess in the reserve, any weapon, including any firearm.

Penalty: \$500.

**113. Open fires prohibited**

A person must not light an open fire in the reserve.

Penalty: \$500.

## **Part 9A — Fish Habitat Protection Areas**

*[Heading inserted in Gazette 23 Dec 2003 p. 5205.]*

### **Division 1A — Abrolhos Islands Fish Habitat Protection Area**

*[Heading inserted in Gazette 30 May 2014 p. 1719.]*

#### **113AA. Notice of travel to Abrolhos Islands Fish Habitat Protection Area**

- (1) The master of a boat must not use the boat to travel to the Abrolhos Islands Fish Habitat Protection Area unless the master gives notice to the CEO of the period of stay of the boat in the Abrolhos Islands Fish Habitat Protection Area in accordance with this regulation.

Penalty: a fine of \$500.

- (2) Notice of the period of stay of a boat is given in accordance with this regulation if —
  - (a) the notice is given in a manner and form approved by the CEO; or
  - (b) the notice is given under a management plan that applies in respect of the travel; or
  - (c) the notice is given in connection with an approval to carry out building work or maintenance work in the Abrolhos Islands Fish Habitat Protection Area or the Abrolhos Islands reserve.

*[Regulation 113AA inserted in Gazette 30 May 2014 p. 1719.]*

#### **113AB. Notice of stay in Abrolhos Islands Fish Habitat Protection Area**

The master of a boat in respect of which a post-landing nomination has been made under the *West Coast Rock Lobster Managed Fishery Management Plan 2012* must not allow the

boat to remain in the Abrolhos Islands Fish Habitat Protection Area unless —

- (a) the master gives notice to the CEO of the boat's departure from the Abrolhos Islands Fish Habitat Protection Area in a manner and form approved by the CEO; and
- (b) the departure day is within a period of 5 days commencing on the making of the post-landing nomination.

Penalty: a fine of \$500.

*[Regulation 113AB inserted in Gazette 30 May 2014 p. 1719-20.]*

### **Division 1 — Cottesloe Reef Fish Habitat Protection Area**

*[Heading inserted in Gazette 23 Dec 2003 p. 5205.]*

#### **113A. Prohibited activities**

- (1) A person must not fish for a commercial purpose in the Cottesloe Reef waters.

Penalty: \$2 000 and the penalty provided in section 222 of the Act.

- (2) A person must not engage in recreational fishing in the Cottesloe Reef waters.

Penalty: \$2 000 and the penalty provided in section 222 of the Act.

- (3) Subregulation (2) does not apply to —

- (a) a person who fishes for an abalone; or
- (b) a person who fishes for a rock lobster; or
- (c) a person who fishes for an osteichthye using a single rod and line.

- (4) A person must not deposit, or cause or permit to be deposited, blood or offal in the Cottesloe Reef waters.

**Fish Resources Management Regulations 1995**

**Part 9A** Fish Habitat Protection Areas

**Division 2** Lancelin Island Lagoon Fish Habitat Protection Area

**r. 113B**

---

Penalty: \$2 000.

- (5) A person must not use a jet ski in the Cottesloe Reef waters.

Penalty: \$1 000.

- (6) A person must not anchor a boat in the Cottesloe Reef waters.

Penalty: \$1 000.

*[Regulation 113A inserted in Gazette 23 Dec 2003 p. 5205.]*

**Division 2 — Lancelin Island Lagoon Fish Habitat Protection Area**

*[Heading inserted in Gazette 23 Dec 2003 p. 5205.]*

**113B. Prohibited activities**

- (1) A person must not fish in the Lancelin Island Lagoon.

Penalty: \$2 000 and the penalty provided in section 222 of the Act.

- (2) A person must not use a jet ski in the Lancelin Island Lagoon.

Penalty: \$1 000.

- (3) A person must not anchor a boat in the Lancelin Island Lagoon.

Penalty: \$1 000.

*[Regulation 113B inserted in Gazette 23 Dec 2003 p. 5205-6.]*

**Division 3 — Kalbarri Blue Holes Fish Habitat Protection Area**

*[Heading inserted in Gazette 21 Dec 2007 p. 6326.]*

**113C. Prohibited activities**

- (1) A person must not fish in the Kalbarri Blue Holes waters.

Penalty: \$2 000 and the penalty provided in section 222 of the Act.

- (2) A person must not use a motor boat in the Kalbarri Blue Holes waters.

Penalty: \$1 000.

*[Regulation 113C inserted in Gazette 21 Dec 2007 p. 6326.]*

#### **Division 4 — Point Quobba Fish Habitat Protection Area**

*[Heading inserted in Gazette 3 Jul 2009 p. 2679.]*

##### **113D. Terms used**

In this Division —

***Point Quobba restricted area*** means the portion of the waters of Point Quobba bounded by a line commencing at the intersection of the high water mark on the coastline and 24° 29.075' south latitude, from there southerly along the geodesic to the intersection of 24° 29.619' south latitude and 113° 24.440' east longitude, from there east along the parallel to the intersection of 24° 29.619' south latitude and 113° 24.975' east longitude, from there north along the meridian to the intersection of the high water mark on the coastline and 133° 24.975' east longitude, from there generally north westerly along the high water mark to the commencement point;

***waters of Point Quobba*** has the meaning given in the *Point Quobba Fish Habitat Protection Area Order 2004*.

*[Regulation 113D inserted in Gazette 3 Jul 2009 p. 2679-80.]*

##### **113E. Prohibited activities**

- (1) A person must not fish in the Point Quobba restricted area.  
Penalty: \$2 000 and the penalty provided in section 222 of the Act.
- (2) Subregulation (1) does not apply to —
- (a) a person who takes oysters by hand other than for a commercial purpose; or
  - (b) a person who takes squid using a squid jig without bait.

***Fish Resources Management Regulations 1995***

**Part 9A** Fish Habitat Protection Areas

**Division 4** Point Quobba Fish Habitat Protection Area

**r. 113E**

---

- (3) A person must not use a jet ski in the Point Quobba restricted area.

Penalty: \$1 000.

*[Regulation 113E inserted in Gazette 3 Jul 2009 p. 2680.]*



## Part 10 — Register

### 114. Hours, place and fees prescribed (Act s. 124)

- (1) The register is available for public inspection between the hours of 8.30 a.m. and 4.30 p.m. on Monday to Friday, other than public holidays at —

The Department of Fisheries  
The Atrium  
168-170 St. George's Tce.  
PERTH WA 6000

- (2) On payment of the fee set out —
- (a) in item 2 of Part 1 of Schedule 1, a person may obtain a copy of an entry in, or an extract from, the register; and
  - (b) in item 3 of Part 1 of Schedule 1, a person may have access to the register in electronic form for such period of time as is specified by the Registrar.

*[Regulation 114 amended in Gazette 7 Jul 1998 p. 3614;  
23 May 2006 p. 1860.]*

### 115. Details prescribed (Act s. 126(e))

The following details are prescribed under section 126(e) of the Act as additional details to be set out on the register —

- (a) the date the authorisation or exemption was granted or renewed and the date it expires; and
- (b) the authorisation or exemption number specified on each authorisation or exemption; and
- (c) any conditions imposed on the authorisation or exemption by the Minister or CEO, either in full, abbreviated or by reference to another text; and
- (d) any period during which the authorisation is suspended; and

**r. 116**

---

- (e) the nature of any entitlement conferred by the authorisation; and
- (f) details of any boat specified in the authorisation.

*[Regulation 115 amended in Gazette 6 Jul 2007 p. 3389-90.]*

**116. Details of security interest prescribed (Act s. 128(2)(c))**

The following details are prescribed under section 128(2)(c) of the Act as additional details in respect of the notation of a security interest on the register —

- (a) the date of the creation of the interest; and
- (b) the date of notation of the interest; and
- (c) any entitlement affected by the interest, including, if the entitlement is an entitlement under a management plan and is expressed in terms of units, the number of units, if any, affected by the interest; and
- (d) any debt or other pecuniary obligation secured by the interest.

*[Regulation 116 amended in Gazette 30 Nov 2004 p. 5487.]*

## **Part 11 — Authorisations**

### **Division 1 — Commercial fishing**

*[Heading inserted in Gazette 29 Jun 2001 p. 3164.]*

#### **117. Fishing boats, duties of masters etc. as to licences, LFB numbers etc.**

- (1) A person having the day to day control of any boat used or intended to be used for or in connection with commercial fishing, must ensure that a current fishing boat licence is in force in respect of the boat.  
Penalty: \$10 000.
- (2) The holder of a fishing boat licence must ensure that the name of the boat in respect of which the licence is in force is not changed without the written approval of the CEO.  
Penalty: \$5 000.
- (3) Subregulation (2) applies whether or not there has been a change in the ownership of the boat or in the licensed fishing boat number of the boat.
- (4) The holder of a fishing boat licence must ensure that there is legibly painted on both sides of the hull at the turn of the bow of the boat in respect of which that licence is held, the letters “L.F.B.” followed by the licensed fishing boat number of the boat.  
Penalty: \$1 000.
- (5) The letters and figures to be painted under subregulation (4) are to be painted in black on a yellow background and are to be not less than 300 mm in height and not less than 50 mm in width, except where the boat is one propelled solely by oars in which case those letters and figures may be less than 150 mm but not less than 120 mm in height.
- (6) A person must not —
  - (a) use a boat bearing a licensed fishing boat number, or a number that purports to be such a number; or

- (b) permit or suffer a person to use a boat bearing a licensed fishing boat number, or a number which purports to be such a number,

unless a current fishing boat licence is in force in respect of that boat and the number painted on the boat is the number allocated in respect of the boat.

Penalty: \$5 000.

- (7) The master of a fishing boat must not permit or suffer any person aboard the boat in respect of which the licence is held to engage in fishing unless that person —

(a) holds a commercial fishing licence and is fishing for a commercial purpose; or

(b) is a participant in a fishing tour on or from the boat.

Penalty: a fine of \$2 000.

- (8) A person aboard a fishing boat must not engage in fishing unless the person —

(a) holds a commercial fishing licence and is fishing for a commercial purpose; or

(b) is a participant in a fishing tour on or from the boat.

Penalty: a fine of \$2 000.

*[Regulation 117 amended in Gazette 29 Jun 2001 p. 3164; 27 Jun 2003 p. 2390; 6 Jul 2007 p. 3389-90; 2 Nov 2011 p. 4624-5.]*

**118. Fishing boat licences, grant of**

- (1) If a person applies to the CEO for the grant of a fishing boat licence authorising a person to use a boat for commercial fishing and the CEO is satisfied that —

(a) the person is a fit and proper person to hold the licence; and

(b) it is in the better interests of the fishing industry to grant the licence; and

- (c) a Certificate of Survey has been issued in respect of that boat in accordance with the *W.A. Marine (Surveys and Certificates of Survey) Regulations 1983*; and
- (d) the boat does not have the same name as any other licensed fishing boat,

the CEO may grant to the person a fishing boat licence.

- (2) Nothing in subregulation (1) prevents the CEO from granting another fishing boat licence to a person who held a fishing boat licence which was cancelled under section 143, 223 or 224 of the Act.
- (3) A fishing boat licence is to specify a distinguishing letter and number (licensed fishing boat number) allocated in respect of the boat.

*[Regulation 118 amended in Gazette 6 Jul 2007 p. 3389.]*

**118A. Fishing boat licence of no effect in some circumstances**

- (1) At any time when a managed fishery licence —
  - (a) has been granted in respect of the West Coast Rock Lobster Managed Fishery declared under the *West Coast Rock Lobster Management Plan 1993*; and
  - (b) authorises the use in that fishery of the same boat in respect of which a fishing boat licence is in force; and
  - (c) confers a current entitlement, or a usual entitlement, of less than 60 units,

the authority conferred by the fishing boat licence referred to in paragraph (b) is of no effect.

- (2) In subregulation (1) —

**current entitlement** means the entitlement conferred by a managed fishery licence as —

  - (a) increased by any entitlement transferred to the licence under section 141 of the Act; or

- (b) decreased by any entitlement transferred from the licence under section 141 of the Act;

*usual entitlement* means the entitlement conferred by a managed fishery licence without regard to any entitlement transferred to or from the licence under section 141 of the Act.

[Regulation 118A inserted in Gazette 8 Sep 2000 p. 5187; amended in Gazette 14 Nov 2001 p. 5978-9; 18 Nov 2011 p. 4810.]

**119. Carrier boats, duties of masters etc. as to licences, LCB numbers etc.**

- (1) In this regulation and regulation 120 —
- carrier boat* means a boat used or intended to be used for transporting fish for commercial purposes that have been taken with the use of another boat but does not include a tender dinghy to a licensed fishing boat which —
- (a) does not exceed 6 m in length; and
- (b) is used for carrying fish taken by that boat.
- (2) The person having the day to day control of a carrier boat must ensure that a current carrier boat licence is in force in respect of the boat.
- Penalty: \$10 000.
- (3) The holder of a carrier boat licence must ensure that there is legibly painted on both sides of the hull at the turn of the bow of the boat in respect of which the licence is in force, the letters “L.C.B.” followed by the licensed carrier boat number of the boat.
- Penalty: \$1 000.
- (4) The letters and figures to be painted under subregulation (3) are to be painted in black on a yellow background and are to be not less than 300 mm in height and not less than 50 mm in width.

- (5) Where a boat is licensed under both this regulation and regulation 117, subregulation (3) need not be complied with.
- (6) A person must not —
- (a) use a boat bearing a licensed carrier boat number, or a number which purports to be such a number; or
  - (b) permit or suffer a person to use a boat bearing a licensed carrier boat number, or a number which purports to be such a number,

unless a current carrier boat licence is in force in respect of that boat and the number painted on the boat is the number allocated in respect of the boat.

Penalty: \$5 000.

*[Regulation 119 amended in Gazette 15 Jan 1999 p. 113.]*

**120. Carrier boat licences, grant of**

- (1) If a person applies to the CEO for the grant of a carrier boat licence authorising that person to use a boat as a carrier boat and the CEO is satisfied that —
- (a) the person is a fit and proper person to hold the licence; and
  - (b) it is in the better interests of the fishing industry to grant the licence,

the CEO may grant to the person a carrier boat licence.

- (2) Nothing in subregulation (1) prevents the CEO from granting another carrier boat licence to a person who held a carrier boat licence which was cancelled under section 143, 223 or 224 of the Act.
- (3) A carrier boat licence is to specify a distinguishing number (licensed carrier boat number) allocated in respect of the boat.

*[Regulation 120 amended in Gazette 6 Jul 2007 p. 3389.]*

**121. Commercial fishing licence, when required**

- (1) A person, other than a person referred to in section 91(d) of the Act, who engages in commercial fishing must hold a commercial fishing licence.
- (2) A person, other than a person referred to in section 91(d) of the Act, who takes fish or assists in taking fish must not directly or indirectly sell that fish unless it is taken under a commercial fishing licence by the holder of that licence.

Penalty: \$5 000 and the penalty provided in section 222 of the Act.

**122. Commercial fishing licences, grant of**

- (1) If a person applies to the CEO for the grant of a commercial fishing licence authorising that person to engage in commercial fishing and the CEO is satisfied that it is in the better interests of the fishing industry to grant the licence the CEO may do so.
- (2) The CEO must issue a receipt to a person who has applied for the grant or renewal of a commercial fishing licence.
- (3) A receipt issued under subregulation (2) is to —
  - (a) be in a form approved by the CEO; and
  - (b) specify the following —
    - (i) the name of the person who applied for the grant or renewal of the licence;
    - (ii) the date on which the receipt was issued.

*[Regulation 122 amended in Gazette 6 Jul 2007 p. 3389;  
26 Aug 2014 p. 3083.]*

**123A. Commercial fishing licence receipt may have effect as commercial fishing licence**

- (1) In this regulation —

*applicant* means a person who has applied for the grant or renewal of a commercial fishing licence;



**commercial fishing licence receipt** means a receipt issued under regulation 122(2).

- (2) A commercial fishing licence receipt issued to an applicant has effect as if it was a commercial fishing licence granted to the applicant until —
- (a) the CEO gives notice to the applicant of the outcome of the application; or
  - (b) the expiration of one month after the date on which the receipt was issued,

whichever occurs first.

- (3) Despite subregulation (2), a commercial fishing licence receipt does not have effect as if it was a commercial fishing licence if the applicant to whom it was issued —
- (a) was the holder of a commercial fishing licence which was cancelled, or not renewed, by the CEO; or
  - (b) has been convicted of an offence against the Act; or
  - (c) is not in possession of the receipt when engaging in commercial fishing.

*[Regulation 123A inserted in Gazette 26 Aug 2014 p. 3083-4.]*

## **Division 2 — Recreational fishing**

*[Heading inserted in Gazette 29 Jun 2001 p. 3164.]*

### **Subdivision 1 — Recreational fishing licence**

*[Heading inserted in Gazette 12 Feb 2010 p. 584.]*

#### **123. Recreational fishing licence, when required**

- (1) A person who carries out any activity set out in the Table to regulation 124 must hold a recreational fishing licence specifying that the person may engage in the activity unless —
- (a) the activity is carried out for a commercial purpose; or

- (b) the person is an Aboriginal person not required to hold a recreational fishing licence under section 6 of the Act.

Penalty: \$2 000.

*[(2) deleted]*

*[Regulation 123 amended in Gazette 12 Feb 2010 p. 584; 1 Mar 2011 p. 675; 2 Nov 2011 p. 4625.]*

**124. Recreational fishing licences, grant of**

- (1) If a person applies to the CEO for the grant of a recreational fishing licence authorising that person to engage in an activity by way of recreational fishing the CEO may grant to the person a recreational fishing licence to engage in the activity.
- (2) A recreational fishing licence is to —
- (a) specify that the person who holds the licence may engage in one or more of the activities set out in the Table to this regulation; and
- (b) specify any letters and numbers (gear identification number) allocated in respect of the licence, where the licence specifies that the licence holder may fish for rock lobster or fish by means of a fishing net.

**Table**

<u>Item</u>	<u>Activities</u>
1.	Fishing for rock lobster
2.	Fishing for marron
3.	Fishing for abalone
4.	Fishing for all freshwater fish (other than crustaceans) in waters south of 29° south latitude above the tidal influence including all lakes, dams, rivers and their tributaries
5.	Fishing by means of a fishing net

- (3) The CEO must issue a receipt to a person who has applied for the grant or renewal of a recreational fishing licence.
- (4) A receipt issued under subregulation (3) is to —
  - (a) be in a form approved by the CEO; and
  - (b) specify the following —
    - (i) the date on which the receipt was issued;
    - (ii) the activity referred to in subregulation (2)(a) in respect of which the application is made;
    - (iii) any letters and numbers that may be allocated in respect of a licence to which the application relates under subregulation (2)(b).

*[Regulation 124 amended in Gazette 6 Jul 2007 p. 3389;  
14 Sep 2012 p. 4373.]*

**124A. Recreational fishing licence receipt may have effect as a recreational fishing licence**

- (1) In this regulation —

*applicant* means a person who has applied for the grant or renewal of a recreational fishing licence;

*recreational fishing licence receipt* means a receipt issued under regulation 124(3).
- (2) A recreational fishing licence receipt issued to an applicant has effect as if it was a recreational fishing licence granted to the applicant until —
  - (a) the CEO gives notice to the applicant of the outcome of the application; or
  - (b) the expiration of one month after the date on which the receipt was issued,

whichever occurs first.

- (3) Despite subregulation (2), a recreational fishing licence receipt does not have effect as if it was a recreational fishing licence if the applicant to whom it was issued —
- (a) was the holder of a recreational fishing licence or a recreational (boat) fishing licence which was cancelled, or not renewed by the CEO; or
  - (b) has been convicted of an offence against the Act; or
  - (c) is not in possession of the receipt when engaging in an activity specified in the receipt.

*[Regulation 124A inserted in Gazette 14 Sep 2012 p. 4373-4.]*

**Subdivision 2 — Recreational (boat) fishing licence**

*[Heading inserted in Gazette 12 Feb 2010 p. 584.]*

**124B. Recreational (boat) fishing licence, when required**

- (1) In this regulation —
- boat* means a vessel propelled by a motor;
- day* has the meaning given in section 50 of the Act.
- (2) A person who fishes by use of a boat must hold a recreational (boat) fishing licence unless —
- (a) the person is not required to hold a recreational (boat) fishing licence under subregulation (3); or
  - (b) the person is not required to hold a recreational (boat) fishing licence under subregulation (5); or
  - (c) the person is fishing for a commercial purpose; or
  - (d) the person is an Aboriginal person not required to hold a recreational fishing licence under section 6 of the Act; or
  - (e) the person is participating in a fishing tour on board a boat that is specified on a fishing tour operator's licence, or a restricted fishing tour operator's licence, granted under regulation 128J.

Penalty: a fine of \$2 000.

- (3) A person (an *unlicensed person*) is not required to hold a recreational (boat) fishing licence to fish by use of a boat if —
- (a) at least one person who holds a recreational (boat) fishing licence is on the boat with the unlicensed person; and
  - (b) on the day on which the unlicensed person fishes by use of the boat, the quantity of fish taken or brought onto land by use of the boat does not exceed any combined bag limit calculated under subregulation (5A).
- (4) The master of a boat must ensure that the quantity of fish taken or brought onto land by use of the boat on a day does not exceed any combined bag limit calculated under subregulation (5A).
- (5A) For the purposes of subregulations (3)(b) and (4), if —
- (a) fish are taken or brought onto land using a boat; and
  - (b) a bag limit is prescribed in respect of those fish for a region or area,
- the combined bag limit for the boat in relation to those fish and that region or area is calculated by multiplying the bag limit by the number of persons who on the day are on the boat and hold a recreational (boat) fishing licence.
- (5B) It is a defence in proceedings for an offence under subregulation (4) for the person charged to prove that —
- (a) the person took all reasonable steps to determine which of the other persons on the boat on that day held a recreational (boat) fishing licence; and
  - (b) the person held a reasonable, but mistaken, belief that a person on the boat on the day held a recreational (boat) fishing licence; and
  - (c) if the person's belief had not been mistaken, the quantity of fish taken or brought onto land by use of the boat on that day would not have exceeded the relevant combined bag limit.

(5) A person is not required to hold a recreational (boat) fishing licence to fish by use of a boat if the person in doing so engages only in an activity set out in the Table to regulation 124 for which the person holds a recreational fishing licence specifying that the person may engage in that activity.

(6) This regulation does not limit the operation of regulation 123.

*[Regulation 124B inserted in Gazette 12 Feb 2010 p. 584-5; amended in Gazette 24 Aug 2011 p. 3405-6; 30 May 2014 p. 1720-1.]*

**124C. Recreational (boat) fishing licences, grant of**

(1) If a person applies to the CEO, the CEO may grant to the person a recreational (boat) fishing licence.

(2) The CEO must issue a receipt to a person who has applied for the grant or renewal of a recreational (boat) fishing licence.

(3) A receipt issued under subregulation (2) is to —

- (a) be in a form approved by the CEO; and
- (b) specify the date on which the receipt was issued.

*[Regulation 124C inserted in Gazette 14 Sep 2012 p. 4374.]*

**124D. Recreational (boat) fishing licence receipt may have effect as a recreational (boat) fishing licence**

(1) In this regulation —

***applicant*** means a person who has applied for the grant or renewal of a recreational (boat) fishing licence;

***recreational (boat) fishing licence receipt*** means a receipt issued under regulation 124C(2).

(2) A recreational (boat) fishing licence receipt issued to an applicant has effect as if it was a recreational (boat) fishing licence granted to the applicant until —

- (a) the CEO gives notice to the applicant of the outcome of the application; or

- (b) the expiration of one month after the date on which the receipt was issued,
- whichever occurs first.
- (3) Despite subregulation (2), a recreational (boat) fishing licence receipt does not have effect as a recreational (boat) fishing licence if the applicant to whom it was issued —
- (a) was the holder of a recreational fishing licence or a recreational (boat) fishing licence which was cancelled or not renewed by the CEO; or
  - (b) has been convicted of an offence against the Act; or
  - (c) is not in possession of the receipt when engaging in an activity specified in the receipt.

*[Regulation 124D inserted in Gazette 14 Sep 2012 p. 4374-5.]*

### **Division 3 — Specific fish or specific methods of fishing**

*[Heading inserted in Gazette 29 Jun 2001 p. 3164.]*

#### **125. Rock lobster pot licence, when required**

- (1) A person who uses one or more rock lobster pots to engage in the commercial fishing of rock lobster must hold a rock lobster pot licence.  
Penalty: \$5 000.
- (2) A person who holds a rock lobster pot licence must not use any rock lobster pots in excess of the number specified in that licence as being the number authorised to be used under the licence.  
Penalty: \$5 000.
- (3) This regulation does not apply to a person using a rock lobster pot in a managed fishery in accordance with an authorisation granted in respect of that fishery.

**126. Rock lobster pot licence, grant of**

If a person applies to the CEO for the grant of a rock lobster pot licence authorising that person to engage in the commercial fishing of rock lobster and the CEO is satisfied that —

- (a) the person is a fit and proper person to hold the licence; and
- (b) it is in the better interests of the fishing industry to grant the licence,

the CEO may grant to the person a rock lobster pot licence.

*[Regulation 126 amended in Gazette 6 Jul 2007 p. 3389.]*

*[127, 128. Deleted in Gazette 4 Sep 2007 p. 4520.]*

*[Division 4: (r. 128A, 128B, 128D, 128E, 128G-128H deleted in Gazette 30 May 2014 p. 1735; 128C, 128F deleted in Gazette 27 Jun 2003 p. 2390.)*

**Division 5 — Fishing tour operators**

*[Heading inserted in Gazette 29 Jun 2001 p. 3171.]*

**128IA. Term used: boat**

In this Division —

**boat** means a vessel propelled by a motor.

*[Regulation 128IA inserted in Gazette 30 May 2014 p. 1726.]*

**128I. Requirements for person conducting fishing tour using boat**

A person who uses a boat to conduct a fishing tour for a commercial purpose in a zone set out in Schedule 15 —

- (a) must be the master of the boat; and
- (b) must be authorised under a fishing tour operator's licence or a restricted fishing tour operator's licence for that zone to conduct the fishing tour.

Penalty: a fine of \$10 000.



*[Regulation 128I inserted in Gazette 30 May 2014 p. 1726.]*

**128J. Fishing tour operator's licence, grant of**

- (1) If a person applies to the CEO for the grant of a fishing tour operator's licence to conduct a fishing tour for a commercial purpose in a zone set out in Schedule 15 and the CEO is satisfied that —
- (a) the person is a fit and proper person to hold the licence; and
  - (b) it is in the interests of the management of commercial and recreational fishing to grant the licence,

the CEO may grant to the person a fishing tour operator's licence for that zone.

- (1a) If a person applies to the CEO for the grant of a restricted fishing tour operator's licence to conduct a fishing tour for a commercial purpose in a zone set out in Schedule 15 and the CEO is satisfied that —
- (a) the person is a fit and proper person to hold the licence; and
  - (b) it is in the interests of the management of commercial and recreational fishing to grant the licence,

the CEO may grant to the person a restricted fishing tour operator's licence for that zone.

- (2) A fishing tour operator's licence or a restricted fishing tour operator's licence is to —
- (a) specify the name and business address of the holder of the licence; and
  - (ba) specify the name of each person authorised to conduct a fishing tour under the licence; and
  - (b) specify the licence number; and
  - (c) specify the period for which the licence has been granted; and

- (d) specify the zone or a part of a zone in which a fishing tour may be conducted under the licence; and
  - [(e) deleted]*
  - (f) specify any conditions that the CEO has imposed in relation to the grant of the licence; and
  - (g) specify the following in relation to each boat that may be used in connection with a tour conducted under the licence —
    - (i) the name of the boat;
    - (ii) the length of the boat;
    - (iii) the licence number of the boat (if any);and
  - (h) specify the number of passengers nominated by the holder of the licence as the maximum number of passengers participating in a tour conducted under the licence.
- (3) A person must not be specified under subregulation (2)(ba) on a fishing tour operator's licence, or restricted fishing tour operator's licence, unless the CEO is satisfied that the person is a fit and proper person to conduct a fishing tour under the licence.
- (4) A person must not continue to be specified under subregulation (2)(ba) on a fishing tour operator's licence or a restricted fishing tour operator's licence if the CEO ceases to be satisfied that the person is a fit and proper person to conduct a fishing tour under the licence.

*[Regulation 128J inserted in Gazette 29 Jun 2001 p. 3171-2; amended in Gazette 27 Jun 2003 p. 2391; 6 Jul 2007 p. 3389; 30 May 2014 p. 1727-8.]*

**128K. Master of fishing boat used for fishing tours to notify  
Department of commercial fishing trip**

If a boat that is authorised to be used on a fishing tour is also a licensed fishing boat, the master of the boat must, before taking the boat from the port to fish for a commercial purpose or to conduct a fishing tour for a commercial purpose, give notice of the trip in a manner and form approved by the CEO to the office of the Department nearest to that port.

Penalty: \$2 000.

*[Regulation 128K inserted in Gazette 29 Jun 2001 p. 3172;  
amended in Gazette 27 Jun 2003 p. 2392; 6 Jul 2007 p. 3389.]*

**128L. Documents to be carried on boat etc. connected with fishing  
tour**

- (1) The master of a boat used for or in connection with a fishing tour must cause to be kept on board the boat, vehicle or aircraft —
  - (a) the fishing tour operator's licence or the restricted fishing tour operator's licence under which the conduct of the tour is authorised; and
  - (b) any other authorisation relating to the boat or its crew required to be held under the Act,

or legible copies of those documents.

Penalty: \$2 000.

- (2) Where the CEO considers that it would be impractical to require a person to comply with subregulation (1), the CEO may in writing exempt that person from that subregulation in relation to a boat or a class of boat.
- (3) The master of a boat used in connection with a fishing tour must cause the exemption or a legible copy of it to be kept on board the boat.

Penalty: \$500.

*[Regulation 128L inserted in Gazette 29 Jun 2001 p. 3172-3; amended in Gazette 27 Jun 2003 p. 2392; 6 Jul 2007 p. 3389; 30 May 2014 p. 1728-9.]*

**128MA. Boats used in connection with fishing tour**

- (1) A fishing tour operator's licence or a restricted fishing tour operator's licence is subject to the following conditions —
  - (a) that no more than one tour may be conducted under the licence at any one time;
  - (b) that no more than one boat with a length of 7.5 metres or longer will be used in connection with a fishing tour conducted under the licence at any one time;
  - (c) that during a fishing tour conducted under the licence, each boat used in connection with the tour must be within 5 nautical miles of each other boat used in connection with the tour.
- (2) The holder of a fishing tour operator's licence or a restricted fishing tour operator's licence must ensure that a boat used in connection with a fishing tour conducted under the licence is identified in such manner as the CEO specifies in a written notice given to the holder of the licence.

Penalty for an offence under this subregulation: a fine of \$2 000.

*[Regulation 128MA inserted in Gazette 30 May 2014 p. 1729; amended in Gazette 30 May 2014 p. 1735.]*

**128M. Operators etc. to ensure participants in fishing tour comply with recreational fishing laws**

A person who holds a fishing tour operator's licence or a restricted fishing tour operator's licence or a person who is conducting a fishing tour must not permit or suffer any person participating in a fishing tour to engage in fishing in a manner contrary to the provisions of the Act applicable to recreational fishing.

Penalty: \$2 000.

*[Regulation 128M inserted in Gazette 29 Jun 2001 p. 3173;  
amended in Gazette 27 Jun 2003 p. 2392; 30 May 2014  
p. 1730.]*

*[128N. Deleted in Gazette 1 Mar 2011 p. 672]*

**128OA. Shark tourism activities prohibited on fishing tour**

- (1) A participant in a fishing tour must not —
- (a) use a safety cage the purpose of which is to protect swimmers or divers from sharks; or
  - (b) engage in the tagging or marking of sharks; or
  - (c) use blood, berley or any vibrating, visual, sonic, electronic, electromagnetic or other equipment for the purpose of attracting sharks.

Penalty: \$2 000.

- (2) The person conducting a fishing tour must not —
- (a) provide or use, or allow participants in the tour to use, a safety cage the purpose of which is to protect swimmers or divers from sharks; or
  - (b) engage, or allow participants in the tour to engage, in the tagging or marking of sharks; or
  - (c) provide or use, or allow participants in the tour to use, blood, berley or any vibrating, visual, sonic, electronic, electromagnetic or other equipment for the purpose of attracting sharks.

Penalty: \$10 000.

*[Regulation 128OA inserted in Gazette 4 Dec 2012 p. 5920;  
amended in Gazette 30 May 2014 p. 1730.]*

**128O. Sale of fish taken on fishing tour prohibited**

A person who holds a fishing tour operator's licence or a restricted fishing tour operator's licence or a person acting on a

licence holder's behalf must not sell any fish taken on a tour conducted under the licence.

Penalty: \$10 000.

*[Regulation 128O inserted in Gazette 29 Jun 2001 p. 3174; amended in Gazette 27 Jun 2003 p. 2392.]*

**128P. Boat not to be used for both commercial fishing and fishing tour during single trip**

A person who uses a licensed fishing boat that is specified in a fishing tour operator's licence or a restricted fishing tour operator's licence for or in connection with commercial fishing and a fishing tour in the course of a single trip commits an offence.

Penalty: \$5 000.

*[Regulation 128P inserted in Gazette 27 Jun 2003 p. 2393.]*

*[128Q. Deleted in Gazette 1 Mar 2011 p. 672]*

**128R. Person in charge of restricted fishing tour not to permit rod on boat**

A person conducting a fishing tour under a restricted fishing tour operator's licence must not permit a rod to be kept on board a boat during any period that the boat is being used for the tour.

Penalty: \$5 000.

*[Regulation 128R inserted in Gazette 27 Jun 2003 p. 2393; amended in Gazette 30 May 2014 p. 1730.]*

**128S. Restricted fishing tours, limits on fishing etc. by participants etc.**

(1) In this regulation —

***restricted fishing tour*** means a fishing tour conducted by virtue of a restricted tour operator's licence.

- (2) The master of a boat used for a restricted fishing tour must not allow a participant on the tour to bring onto land any fish from the boat.  
Penalty: \$5 000.
- (3) The master of a boat being used for a restricted fishing tour must not —
- (a) commence the tour with any fish on the boat; or
  - (b) allow any fish to remain on the boat at the end of the tour.
- Penalty: \$10 000.
- (4) The master of a boat being used for a restricted fishing tour must not allow participants on the tour to take more than a reasonable quantity of fish for a meal for those on the boat at the time the fish is taken.  
Penalty: \$5 000.
- (5) It is a defence in proceedings for an offence against subregulation (3) for the person charged to prove that the fish was purchased from a person other than a participant on the tour for the purpose of providing meals for participants on a tour on the boat.

*[Regulation 128S inserted in Gazette 27 Jun 2003 p. 2393-4; amended in Gazette 4 Nov 2005 p. 5312; 30 May 2014 p. 1730.]*

### **Division 6A — Replacement of cancelled authorisations**

*[Heading inserted in Gazette 1 Jul 2011 p. 2722.]*

#### **129A. Terms used**

In this Division —

***authorisation*** means a managed fishery licence granted in respect of the West Coast Rock Lobster Managed Fishery;

***cancelled authorisation*** means authorisation No. 1450 or No. 1493;

**former authorisation holder** means the person who held authorisation No. 1450 or No. 1493 immediately before it was cancelled under section 224;

**section 224** has the meaning given in section 78A(1) of the Act.

*[Regulation 129A inserted in Gazette 1 Jul 2011 p. 2722.]*

**129B. CEO may grant certain replacement authorisations**

- (1) If —
- (a) a former authorisation holder applies on or before 15 August 2011 to the CEO for the grant of an authorisation; and
  - (b) the application is accompanied by —
    - (i) an application fee of \$329.00; and
    - (ii) the relevant replacement authorisation fee set out in subregulation (3),

the CEO may grant to the former authorisation holder an authorisation to replace the former authorisation holder's cancelled authorisation.

- (2) When an authorisation is granted to replace a cancelled authorisation, the replacement authorisation —
- (a) confers the same authority and entitlement that were conferred by the cancelled authorisation immediately before it was cancelled; and
  - (b) is subject to the same conditions to which the cancelled authorisation was subject immediately before it was cancelled.
- (3) The replacement authorisation fee —
- (a) for the grant of an authorisation to replace authorisation No. 1450 — is \$82 180;
  - (b) for the grant of an authorisation to replace authorisation No. 1493 — is \$100 878.

*[Regulation 129B inserted in Gazette 1 Jul 2011 p. 2722-3.]*



### **Division 6 — General**

*[Heading inserted in Gazette 29 Jun 2001 p. 3174.]*

#### **129. Lost etc. authorisations, replacement of**

- (1) The holder of an authorisation that has been lost, damaged or destroyed may apply to the CEO for a replacement for the authorisation.
- (2) An application —
  - (a) must be made as if it were an application to which section 135 of the Act applies; and
  - (b) must be accompanied by the fee set out in item 4 of Part 1 of Schedule 1.

*[Regulation 129 amended in Gazette 6 Jul 2007 p. 3389;  
9 Jun 2009 p. 1911.]*

#### **130. Conditions of licences, imposition of etc.**

- (1) A licence granted under this Part is subject to any conditions imposed in writing by the CEO.
- (2) A licence may be granted or renewed under this Part or transferred subject to such conditions as the CEO thinks fit and specifies in the licence.
- (3) The CEO may at any time, by notice in writing given to the licence holder, delete or vary any condition on a licence imposed under this regulation or add a new condition to the licence.
- (4) A person must not contravene a condition of a licence granted under this Part.

Penalty: \$5 000 and the penalty provided in section 222 of the Act.

*[Regulation 130 amended in Gazette 6 Jul 2007 p. 3389.]*

*[130A. Deleted in Gazette 30 May 2014 p. 1735.]*

**131. Grounds for refusal of transfer of authorisations etc. prescribed (Act s. 140(2)(b))**

- (1) The CEO may, under section 140(2)(b) of the Act, refuse to transfer an authorisation or part of an entitlement under an authorisation on the grounds that —
- (a) the proposed transferor or transferee has not provided information, or further information, required by the CEO for a proper consideration of the application, or has refused to verify such information by statutory declaration; or
  - (b) where the authorisation is held in respect of a boat, the boat is unseaworthy, lost or destroyed; or
  - (ba) where the holder has 2 or more authorisations and all of those authorisations are not simultaneously being transferred to the same transferee, in the opinion of the CEO, it is not in the best interests of the fishery to transfer the authorisation; or
  - (c) the holder has not used the authorisation in the previous 2 years; or
  - (d) the holder has been convicted of an offence against —
    - (i) the Act or these regulations;
    - (ii) a written law other than this Act if the offence relates to the fishing industry; or
    - (iii) a law of the Commonwealth, or of another State or Territory, relating to the management or regulation of fish resources;
- or
- (e) in the opinion of the CEO, a condition of the authorisation has been contravened; or
  - (f) the authorisation was obtained by fraud or misrepresentation; or
  - (g) the holder has —

- (i) failed to keep any record, or submit any return, that is required to be kept or submitted under this Act; or
  - (ii) made an entry or statement in such a record or return that is false or misleading in a material particular;
- or
- (h) a fee, charge or levy payable in respect of the authorisation has not been paid when it became due; or
  - (i) the transfer would contravene a condition of the authorisation or be contrary to a provision of a management plan; or
  - (j) a conviction has been recorded in respect of the authorisation under section 224(1) of the Act.
- (2) For the purposes of subregulation (1)(j), a conviction is taken to have been recorded in respect of an authorisation if —
- (a) a conviction has been recorded in respect of another authorisation under section 224(1) of the Act; and
  - (b) the other authorisation ceases to have effect because the management plan in respect of which it was granted is revoked or expired; and
  - (c) the holding of the other authorisation was a fact that the CEO took into account when granting the authorisation.

*[Regulation 131 amended in Gazette 29 Jun 2001 p. 3175; 6 Jul 2007 p. 3389; 9 Sep 2014 p. 3239-40.]*

**132. Short term use of boat instead of lost etc. licensed fishing boat etc., authorisation of**

- (1) Despite regulations 117 and 119, where a fishing boat or a carrier boat licence has been granted in respect of a boat and —
  - (a) the boat is unseaworthy, lost or destroyed; or

- (b) the Certificate of Survey, as required under regulation 118(1)(c), for the boat has expired or is cancelled,

the CEO may, on application by the holder of the licence, authorise by notice in writing, the holder to use a boat other than the boat in respect of which the licence was granted.

- (2) An application for an authority under subregulation (1) —
  - (a) is to be made to the CEO in a form approved for that purpose by the CEO; and
  - (b) is to be accompanied by the fee set out in item 6 of Part 2 of Schedule 1.
- (3) An authority under this regulation —
  - (a) must specify the boat to which the authority relates and the period for which the boat may be used under the licence, being a period not exceeding 28 days; and
  - (b) is subject to any conditions specified in the authority by the CEO.
- (4) The CEO may vary or cancel a condition imposed on an authority under this regulation by notice in writing given to the holder of the authority.
- (5) The CEO may vary or cancel an authority under this regulation by notice in writing given to the holder of the authority.
- (6) A person to whom an authority has been granted under this regulation must not contravene that authority while it is in force.  
Penalty: \$5 000.

*[Regulation 132 amended in Gazette 6 Jul 2007 p. 3389.]*

### **133. Duration of licences**

Except as otherwise provided in the Act or in the licence, a licence granted under this Part remains in force for a period of 12 months from the day on which it is granted or renewed.

**134. Renewal of licences**

If a person applies to the CEO for the renewal of a licence granted under this Part, the CEO is, subject to section 143 of the Act, to renew the licence.

*[Regulation 134 amended in Gazette 6 Jul 2007 p. 3389.]*

**135. Application fees**

A fee set out in Part 2 of Schedule 1 opposite a particular type of application is the fee to be paid to make that application.

**136. Recreational fishing licence fee halved for pensioners etc.**

(1) In this regulation —

*recreational fishing licence* includes a recreational (boat) fishing licence applied for under regulation 124C.

(2) Where a recreational fishing licence is applied for by —

(a) a person under the age of 16 years; or

(b) a person receiving —

(i) under the *Social Security Act 1991* of the Commonwealth, an age, disability support or widows pension or allowance;

(ii) a pension under the *Coal Industry Superannuation Act 1989*;

(iii) under the *Veterans Entitlements Act 1986* of the Commonwealth, a pension as a widow of a member of the forces, a service pension or the special rate of pension as a person who is totally and permanently incapacitated;

or

(c) a person who is the spouse, widow or widower of a person referred to in paragraph (b); or

(ca) a person who —

(i) is the de facto partner of a person referred to in paragraph (b); or

(ii) if the person referred to in paragraph (b) has died, was the de facto partner of that person immediately before the death of that person;

or

(d) a person who is the holder of a Seniors' Card issued by the Office of Seniors Interests,

only one half of the fee otherwise applicable is payable.

*[Regulation 136 amended in Gazette 30 Jun 2003 p. 2603;  
12 Feb 2010 p. 585-6.]*

**137. Fees for grant or renewal of authorisation**

- (1) A fee set out in Part 3 of Schedule 1 opposite a particular type of authorisation is the fee to be paid in respect of the grant or renewal of the authorisation.
- (1a) Any term used in a subitem of Schedule 1 Part 3 item 3 has the same meaning as it is given in the management plan for that managed fishery.
- (2) If the relevant management plan provides for the payment by instalments of a fee set out in item 3 of Part 3 of Schedule 1, the fee may be paid in 2 or 3 instalments in accordance with the relevant management plan.
- (3) If a fee referred to in subregulation (2) is to be paid by instalments, a surcharge of —
  - (a) 10% of that fee; or
  - (b) any lesser percentage of that fee, if such a percentage is specified in the relevant management plan,is payable with the first instalment.
- (4) If an instalment of a fee, including the surcharge if payable with that instalment, is not paid on or before the day specified in the relevant management plan (the *due date*) —
  - (a) the full amount outstanding of the fee becomes immediately payable; and

- (b) the authority conferred by the authorisation to which the fee applies is of no effect during the period from the due date until the day on which the full amount outstanding of the fee is paid.
- (5) In subregulation (4) —  
***full amount outstanding of the fee*** includes the surcharge payable under subregulation (3).
- (6) If —
- (a) an application is made under regulation 124; and
  - (b) the application relates to 2 or more of the activities set out in the Table to that regulation,
- the fees set out in Schedule 1 Part 3 item 8 to be paid in respect of the grant of the recreational fishing licence are each to be reduced by 10%.
- (7) Subregulation (8) applies if —
- (a) an application is made by a person under regulation 124 relating to one or more of the activities set out in the Table to that regulation; and
  - (b) at the same time an application is made by the person under regulation 124C.
- (8) If this subregulation applies —
- (a) the fee or fees set out in Schedule 1 Part 3 item 8 to be paid in respect of the grant of the recreational fishing licence; and
  - (b) the fee set out in Schedule 1 Part 3 item 9 to be paid in respect of the grant of the recreational (boat) fishing licence,

are each to be reduced by 10%.

*[Regulation 137 amended in Gazette 24 Dec 1996 p. 7114; 5 Sep 2006 p. 3615; 12 Feb 2010 p. 586.]*

**138. Transfer of part of entitlement not permitted in some cases**

Part of an entitlement under an authorisation may not be transferred under section 141 of the Act for a period ending on a day after the authorisation would expire, if it were not renewed.

**139. Change of name or address, duty to notify CEO**

If a person who holds an exemption, authorisation, aquaculture lease or exclusive licence changes name or address, the person must within 7 days after the change notify the CEO in writing of the person's new name or address and provide details of each exemption, authorisation, aquaculture lease or exclusive licence held by the person.

Penalty: \$200.

*[Regulation 139 amended in Gazette 6 Jul 2007 p. 3389.]*



## Part 12 — Fish trafficking

[Heading inserted in Gazette 18 Jun 2013 p. 2296.]

### 140. Priority fish

- (1) For the purposes of paragraph (a) of the definition of *priority fish* in section 153 of the Act each of the species of fish set out in the Table is declared to be a priority species.

Table

Abalone, Brownlip
Abalone, Greenlip
Abalone, Roe's
Barramundi
Coral Trout
Dhufish, West Australian
Groper, Baldchin
Snapper, Pink

- (2) For the purposes of paragraph (b) of the definition of *priority fish* in section 153 of the Act each of the following groups of species of fish are declared to be a priority group of species —
- (a) all species of rock lobster;
  - (b) all species of finfish.

[Regulation 140 inserted in Gazette 18 Jun 2013 p. 2296-7.]

### 141. Commercial quantity

For the purpose of paragraph (a) of the definition of *commercial quantity* in section 153 of the Act —

- (a) the quantity for fish of a priority species is 10 times the bag limit for that species; and

**r. 141**

---

- (b) the quantity for rock lobster is 10 times the bag limit for rock lobster; and
- (c) the quantity for finfish is 100 kg of fillets.

*[Regulation 141 inserted in Gazette 18 Jun 2013 p. 2297.]*

**[142, 143.** Deleted in Gazette 30 Dec 2004 p. 6965.]

## **Part 13A — Control of disease in pearl oysters**

*[Heading inserted in Gazette 24 Sep 2013 p. 4438.]*

### **144A. Terms used**

(1) In this Part —

***approval to transport*** means approval given under regulation 144G(1);

***approved*** means approved by the CEO;

***batch*** has the meaning given in the *Pearling (General) Regulations 1991* regulation 3(1);

***certificate of health*** means a certificate issued under regulation 144F;

***destroy*** means to entirely consume by fire or to bury in the ground at a depth of not less than 183 cm;

***disease*** means, subject to subregulation (2) —

- (a) a disease mentioned in Schedule 18; or
- (b) a disease that is not mentioned in Schedule 18, but appears not to be an exotic disease within the meaning given in the *Exotic Diseases of Animals Act 1993* section 4(1);

***disinfect*** means to expose to an approved agent or preparation capable of destroying pathogenic organisms;

***farm lease*** has the meaning given in the *Pearling Act 1990* section 3(1);

***hatchery*** has the meaning given in the *Pearling (General) Regulations 1991* regulation 3(1);

***hatchery licence*** has the meaning given in the *Pearling Act 1990* section 3(1);

***hatchery permit*** has the meaning given in the *Pearling Act 1990* section 3(1);

***inspector*** has the meaning given in the *Pearling Act 1990* section 3(1);

**r. 144B**

---

**length** has the meaning given in the *Pearling (General) Regulations 1991* regulation 3(1);

**pearl oyster farm** has the meaning given in the *Pearling Act 1990* section 3(1);

**quarantine site** has the meaning given in the *Pearling (General) Regulations 1991* regulation 3(1);

**settlement** has the meaning given in the *Pearling (General) Regulations 1991* regulation 3(1);

**spat** has the meaning given in the *Pearling (General) Regulations 1991* regulation 3(1);

**spat collector** has the meaning given in the *Pearling (General) Regulations 1991* regulation 3(1);

**Western Australian pearl oyster fishery** means the waters so defined in the *Pearling (Joint Authority Pearl Oyster Fishery) (Declaration of Zones) Notice 1992*;

**zone** has the meaning given in the *Pearling Act 1990* section 3(1).

- (2) A reference in this Part to disease includes a reference to —
- (a) the presence of signs of disease; and
  - (b) the presence of the causative agent of disease; and
  - (c) test results consistent with the presence of disease or the presence of the causative agent of disease; and
  - (d) other evidence of disease,

and **diseased** has a corresponding meaning.

*[Regulation 144A inserted in Gazette 24 Sep 2013 p. 4438-40.]*

**144B. Transport of pearl oysters into the State**

- (1) A person shall not transport live pearl oysters in the State unless —
- (a) the pearl oysters are of Western Australian origin; or
  - (b) the transportation is authorised by the CEO.

Penalty: a fine of \$5 000.

- (2) In this regulation pearl oysters are of Western Australian origin if —
- (a) in the case of hatchery produced spat, the spat is derived from pearl oysters taken from zone 1, 2 or 3 of the Western Australian pearl oyster fishery; or
  - (b) in the case of spat collected from a spat collector, the spat collector is located in zone 1, 2 or 3 of the Western Australian pearl oyster fishery; or
  - (c) in the case of pearl oysters taken from the wild, the pearl oysters were taken from zone 1, 2 or 3 of the Western Australian pearl oyster fishery.

*[Regulation 144B inserted in Gazette 24 Sep 2013 p. 4440-1.]*

**144C. Spat samples to be taken, preserved etc.**

- (1) The holder of a hatchery licence or a hatchery permit shall take a sample from each batch of spat that is settled in the hatchery —
- (a) within 4 days of the end of settlement; and
  - (b) every subsequent 14<sup>th</sup> day, unless a certificate of health is in force in respect of the batch; and
  - (c) not more than 24 hours before the spat is moved out of the hatchery.
- (2) A sample taken for the purposes of subregulation (1) is to be —
- (a) a random sample of not less than —
    - (i) for a sample taken under subregulation (1)(a) or (b), 50 spat; or
    - (ii) for a sample taken under subregulation (1)(c), 150 spat each of which is 2 mm or more in length;
- and

**r. 144D**

---

- (b) preserved in a solution of between 5% and 10% of formalin in sea water; and
- (c) stored in the manner directed by an approved fish pathologist and labelled with the date the sample was taken and the batch number; and
- (d) retained —
  - (i) if the batch of spat is taken from the hatchery to a quarantine site, until all spat from that batch have been removed from the quarantine site; or
  - (ii) otherwise, for 6 weeks.
- (3) A person shall not tamper with a sample taken under this regulation.

Penalty: a fine of \$5 000.

*[Regulation 144C inserted in Gazette 24 Sep 2013 p. 4441-2.]*

**144D. Transport of pearl oysters restricted**

- (1) Except as provided in subregulation (2), a person shall not transport pearl oysters —
  - (a) out of a hatchery; or
  - (b) off a quarantine site; or
  - (c) out of a zone of the Western Australian pearl oyster fishery.

Penalty: a fine of \$5 000.

- (2) Subregulation (1) does not apply if —
  - (a) there is a certificate of health in force in relation to the pearl oysters; or
  - (b) the pearl oysters are transported in accordance with an approval to transport.

*[Regulation 144D inserted in Gazette 24 Sep 2013 p. 4442.]*

**144E. Sampling for disease testing**

- (1) A sample of pearl oysters that is to be submitted to an approved fish pathologist for disease testing is to be —
  - (a) a random sample of as many pearl oysters as an approved fish pathologist reasonably requires for testing; and
  - (b) treated and preserved in the manner directed by an approved fish pathologist.
- (2) A person shall not submit a sample of hatchery produced spat for disease testing unless the sample was taken —
  - (a) at least 40 days after the completion of settlement of that batch; and
  - (b) when the majority of the spat in the batch are 2 mm or more in length.
- (3) An inspector may supervise the taking of samples under this regulation.
- (4) A person shall not tamper with a sample taken under this regulation.  
Penalty: a fine of \$5 000.
- (5) A person submitting a sample for disease testing shall also provide to the approved fish pathologist —
  - (a) a copy of the relevant Notice of Settlement of Spat or Notice of Pearling or Hatchery Activity lodged under the *Pearling (General) Regulations 1991*; and
  - (b) either —
    - (i) particulars in writing of any unexplained mortality, or clinical disease, of pearl oysters; or
    - (ii) a declaration, in the form of Form 8, that no such mortality has occurred and no signs of clinical disease have been seen,

**r. 144F**

---

at the hatchery, quarantine site or other place where the pearl oysters are being held, during the previous 12 months.

- (6) An approved fish pathologist may require a person submitting a sample for disease testing to —
- (a) produce for inspection logbooks and other records kept by the holder of the relevant hatchery licence or hatchery permit; and
  - (b) provide any other information relating to the health standards of the hatchery, quarantine site, or place where the pearl oysters are being held, that the pathologist considers relevant; and
  - (c) provide such further samples of pearl oysters as are required for further testing.
- (7) A person submitting a sample for disease testing must comply with a requirement under subregulation (6).

Penalty: a fine of \$5 000.

*[Regulation 144E inserted in Gazette 24 Sep 2013 p. 4442-4.]*

**144F. Certificates of health for pearl oysters**

- (1) An approved fish pathologist may issue a certificate of health in relation to pearl oysters if the pathologist has tested, in accordance with subregulation (5), a sample of those pearl oysters and is satisfied that —
- (a) the sampled pearl oysters are in good health; and
  - (b) there is no evidence of an unacceptable level of unexplained mortalities or clinical disease among pearl oysters at that hatchery, quarantine site or other place where the pearl oysters are being held, in the preceding 12 months.
- (2) For the purposes of subregulation (1) a sample of pearl oysters is in good health if there is no evidence, among the sampled pearl oysters, of —



- (a) any —
    - (i) virus; or
    - (ii) protozoan (other than symbiotic or opportunistic protozoa); or
    - (iii) metazoan parasites; or
    - (iv) fungal infection; or
    - (v) bacteria; or
    - (vi) rickettsiales,  
that is —
      - (vii) associated with lesions, necrosis or inflammation of pearl oysters; or
      - (viii) known or suspected to be pathogenic to pearl oysters;
  - or
  - (b) unexplained lesions; or
  - (c) an unacceptable level of unexplained mortalities.
- (3) A certificate of health remains in force for 2 weeks from the day on which it is issued unless, before then, it ceases to be in force under regulation 144K.
- (4) A certificate of health is to be in the form of Form 9.
- (5) The tests required by subregulation (1) to be carried out on a sample of pearl oysters are —
- (a) a histological examination of as many formalin-seawater fixed pearl oysters as an approved fish pathologist reasonably requires for testing using haematoxylin and eosin stained longitudinal sections of paraffin embedded tissue; and
  - (b) any other test that the pathologist considers appropriate.

*[Regulation 144F inserted in Gazette 24 Sep 2013 p. 4444-6.]*

**r. 144G**

---

**144G. Approval for transport of pearl oysters**

- (1) The CEO may, in writing, approve the transport of pearl oysters if —
  - (a) an approved fish pathologist has tested, in accordance with regulation 144F, a sample of those pearl oysters; and
  - (b) the fish pathologist —
    - (i) is not satisfied of the matters referred to in regulation 144F(1)(a) because of the presence of oyster oedema disease in the sample; or
    - (ii) is not satisfied of the matters referred to in regulation 144F(1)(b) because of the presence of oyster oedema disease among pearl oysters at the hatchery, quarantine site or other place where the pearl oysters are being held, in the preceding 12 months.
- (2) An approval to transport remains in force for 2 weeks from the day on which it was given unless, before then, it ceases to be in force under regulation 144K.

*[Regulation 144G inserted in Gazette 24 Sep 2013 p. 4446.]*

**144H. Consequences if certificate of health not issued**

- (1) Where a sample of pearl oysters is submitted for disease testing but the approved fish pathologist is not satisfied of the matters referred to in regulation 144F(1)(a) and (b) the pathologist is to give written notice to the person who submitted the sample —
  - (a) stating that a certificate of health will not be issued in relation to the pearl oysters; and
  - (b) setting out the reasons why not; and
  - (c) advising the person that if the reason for not issuing the certificate of health is the presence of oyster oedema disease in the sample, he or she may apply to the CEO for an approval to transport the pearl oysters —

- (i) out of a hatchery; or
  - (ii) off a quarantine site; or
  - (iii) out of a zone of the Western Australian pearl oyster fishery.
- (2) Unless otherwise authorised by the CEO a person given a notice under subregulation (1) shall —
  - (a) within 24 hours of receiving the notice destroy, under the supervision of an inspector and in a manner approved by the CEO —
    - (i) all pearl oysters being held in the hatchery, quarantine site or other place from which the sample was taken; and
    - (ii) such other pearl oysters as the CEO directs;
  - and
  - (b) clean, disinfect and treat all equipment used in relation to the pearl oysters, in a manner approved by the CEO; and
  - (c) where the pearl oysters are in a hatchery, clean, disinfect and treat all water used in the hatchery, in a manner approved by the CEO.
- (3) An inspector may give such additional directions as the inspector considers appropriate in relation to —
  - (a) the destruction of the pearl oysters; and
  - (b) the cleaning, disinfecting or treatment of water and equipment; and
  - (c) the prevention or containment of disease.

*[Regulation 144H inserted in Gazette 24 Sep 2013 p. 4446-7.]*

**144I. Pathologist to notify inspector as to certificate of health**

An approved fish pathologist to whom a sample of pearl oysters is submitted for disease testing is to notify an inspector in Broome within 24 hours of —

**r. 144J**

---

- (a) issuing a certificate of health; or
- (b) determining that the pathologist is not prepared to issue a certificate of health,

in respect of the pearl oysters.

*[Regulation 144I inserted in Gazette 24 Sep 2013 p. 4448.]*

**144J. CEO to notify approval to transport**

Within 24 hours after giving an approval to transport pearl oysters, the CEO is to give notice of that approval to —

- (a) an inspector; and
- (b) the fish pathologist who tested the sample of pearl oysters to which the approval relates.

*[Regulation 144J inserted in Gazette 24 Sep 2013 p. 4448.]*

**144K. Consequences of more than one batch of spat at quarantine site**

- (1) If a batch of spat is moved to a quarantine site at which there is already a batch of spat, any certificate of health or approval to transport in force in respect of that existing batch ceases to be in force.
- (2) If 2 or more batches of spat are kept on a quarantine site at the same time, the holder of the farm lease for the pearl oyster farm on which the quarantine site is located —
  - (a) shall keep the batches separate in an approved manner; and
  - (b) shall sample all of the batches simultaneously; and
  - (c) must not submit a sample for disease testing unless it was taken at least 6 weeks after the arrival of the most recent batch.
- (3) If an approved fish pathologist is not satisfied of the matters referred to in regulation 144F(1)(a) and (b) in relation to a sample from one batch held on a quarantine site —

- (a) the pathologist is not to issue a certificate of health in respect of any of the other batches held on the quarantine site; and
- (b) is to give a notice under regulation 144H(1) in respect of each of those other batches, even if the pathologist has not tested them.

*[Regulation 144K inserted in Gazette 24 Sep 2013 p. 4448-9.]*

**144L. Removal of spat from quarantine site**

The holder of the farm lease for a pearl oyster farm on which a quarantine site is located is to remove all spat in a batch from the quarantine site —

- (a) by the next 31 December after the batch is moved to the quarantine site; or
- (b) within 3 months of the batch being moved to the quarantine site,

whichever occurs first.

*[Regulation 144L inserted in Gazette 24 Sep 2013 p. 4449.]*

**Part 13B — Control of disease in abalone**

*[Heading inserted in Gazette 24 Sep 2013 p. 4449.]*

**144M. Restriction on moving live abalone into the State**

No person shall move live abalone into the State, except —

- (a) with the written approval of the CEO; and
- (b) in compliance with any terms, conditions and restrictions set out in the written approval.

*[Regulation 144M inserted in Gazette 24 Sep 2013 p. 4449-50.]*

## **Part 13 — Miscellaneous offences**

### **144. Certain activities in bays etc. and as to use of traps prohibited**

- (1) A person must not set any fishing gear or any other thing across or within any bay, inlet, river, creek or any tidal or inland waters so that fish are enclosed, left stranded, destroyed or wasted.
- (2) A person must not place, set or use in inland waters, a trap or device enclosed with wire, or wire netting with wings attached so as to impede the free passage of fish on either side of the trap or device.

Penalty: \$1 000.

### **145. Explosives or noxious substances, carriage of on boats**

- (1) A person must not in WA waters carry on, or in, a boat any explosive or noxious substance unless so authorised under subregulation (2).

Penalty: In the case of an individual, \$5 000 or, in the case of a body corporate, \$10 000.

- (2) A fisheries officer may, in writing, authorise a person to carry any explosive or noxious substance on a boat referred to in subregulation (1) and in that authority must specify —
  - (a) the type and amount that may be carried; and
  - (b) the purpose for which it may be carried; and
  - (c) the period of time within which it must be carried; and
  - (d) the boat on, or in, which it may be carried.

### **146. Explosive or noxious substance used to take fish, presumptions as to possession of**

- (1) Where any explosive or noxious substance has been used in WA waters without lawful excuse, resulting in the taking of fish and a person is found in possession of any explosive or noxious substance that person, in the absence of evidence to the

**r. 147A**

---

contrary, is to be presumed to be the person who used the explosive or noxious substance.

- (2) For the purpose of this regulation, the master of a boat on which is found any explosive or noxious substance is to be taken to be in possession of that explosive or noxious substance.

**147A. Arranging for transport by courier business of fish taken recreationally**

- (1) In this regulation —  
*courier business* means a business that —
- (a) has an established place of business; and
  - (b) carries on the business of transporting freight.
- (2) A person must not enter into a contract or other agreement with a person who operates a courier business for the courier business to transport fish that have been taken by recreational fishing.

Penalty: a fine of \$5 000 and the penalty provided in section 222 of the Act.

*[Regulation 147A inserted in Gazette 29 Jan 2013 p. 311.]*

**147B. Installation of fish aggregating device without approval of CEO**

A person must not install any part of a fish aggregating device in WA waters unless —

- (a) the person has submitted a proposal for the fish aggregating device to the CEO in the approved form; and
- (b) the CEO has notified the person in writing that the proposal is approved.

Penalty: In the case of an individual, a fine of \$5 000 or, in the case of a body corporate, a fine of \$10 000.

*[Regulation 147B inserted in Gazette 30 May 2014 p. 1722.]*



## Part 14 — Fisheries officers

### 147. Warrant form prescribed (Act s. 187)

A warrant under section 187 of the Act is to be in the form of Form 2.

### 148. Ways of disposing of fish prescribed (Act s. 194)

For the purposes of section 194(2) of the Act, fish seized under the Act may be —

- (a) given to the Department for its use or transferred, with or without charge, to any other department of the State or Commonwealth; or
- (b) sold at public auction, by tender or by private contract; or
- (c) donated to needy persons, or an institution operated for the benefit of needy persons; or
- (d) destroyed where a fisheries officer is of the opinion that the fish is not fit for human consumption or it is not practical to release, sell or donate the fish.

### 149. Accounts prescribed (Act s. 194)

For the purposes of section 194(3) of the Act proceeds of the sale of any fish under section 194(2) of the Act are to be paid to the credit of —

- (a) the Fisheries Research and Development Fund<sup>4</sup> continued under section 238 of the Act, where the fish was the subject of an offence, or suspected offence, relating to aquaculture, commercial fishing, or processing; and
- (b) the Recreational Fishing Fund<sup>5</sup> established under section 239 of the Act in all other cases.

*[Regulation 149 amended in Gazette 30 May 2014 p. 1735.]*

**r. 150**

---

**150. Applying for compensation (Act s. 197(3))**

- (1) An application to the CEO for compensation under section 197(3) of the Act must be made in writing.
- (2) An application for compensation may contain information regarding the following matters —
  - (a) why compensation is claimed;
  - (b) when the boat or vehicle was used and by whom;
  - (c) what use was made of the boat or vehicle;
  - (d) how the applicant was affected by the use of the boat or vehicle.

*[Regulation 150 amended in Gazette 6 Jul 2007 p. 3389.]*

## Part 15 — Legal proceedings

### 151. Method for determining size etc. of fish prescribed (Act s. 214)

The method prescribed under section 214 of the Act to determine —

- (a) the length of a whole fish listed in column 1 of Part 1 of Schedule 8 is as set out opposite the name of the fish in column 2; and
- (b) the volume of fish, other than oysters, is as set out in Part 2 of Schedule 8; and
- (c) the weight of fish that is packaged and frozen, is by weighing the fish together with any packaging and liquid that is not easily removable from the fish; and
- (d) the length of a fillet or fish trunk is as set out in Part 3 of Schedule 8.

*[Regulation 151 amended in Gazette 1 Oct 2003 p. 4327; 4 Nov 2005 p. 5312-13.]*

### 152. Australian datum prescribed (Act s. 216)

- (1) The Geocentric Datum of Australia (the **GDA**) is the prescribed Australian datum for the purposes of section 216 of the Act.
- (2) The reference ellipsoid for the GDA is the Geodetic Reference System 1980 (**GRS80**) ellipsoid with a semi-major axis of 6 378 137 m exactly and an inverse flattening (1/f) of 298.257 222 101.
- (3) The reference frame for the GDA is realised by the coordinates of the following Australian Fiducial Network geodetic stations referred to the GRS80 ellipsoid determined within the International Earth Rotation Service Terrestrial Reference Frame 1992 (ITRF92) at the epoch of 1994.0 —

**r. 153**

---

No.	Name	South latitude	East longitude	Ellipsoidal height
AU 012	Alice Springs	23° 40' 12.44592"	133° 53' 07.84757"	603.358 m
AU 013	Karratha	20° 58' 53.17004"	117° 05' 49.87255"	109.246 m
AU 014	Darwin	12° 50' 37.35839"	131° 07' 57.84838"	125.197 m
AU 015	Townsville	19° 20' 50.42839"	146° 46' 30.79057"	587.077 m
AU 016	Hobart	42° 48' 16.98506"	147° 26' 19.43548"	41.126 m
AU 017	Tidbinbilla	35° 23' 57.15627"	148° 58' 47.98425"	665.440 m
AU 019	Ceduna	31° 52' 00.01664"	133° 48' 35.37527"	144.802 m
AU 029	Yaragadee	29° 02' 47.61687"	115° 20' 49.10049"	241.291 m

*[Regulation 152 inserted in Gazette 19 Aug 2003 p. 3715.]*

**153. Way of giving notice prescribed (Act s. 219(1))**

The way prescribed for the CEO to give notice under section 219(1) of the Act is by a notice describing the thing seized to be displayed for at least 30 days in a prominent position on a notice board which is clearly visible from outside the office of the Department nearest to where the thing was seized.

*[Regulation 153 amended in Gazette 6 Jul 2007 p. 3389.]*

**154. Things forfeited to Crown, disposal of**

- (1) Any thing (other than fish) forfeited to the Crown under the Act is —
  - (a) to be given to the Department for its use or transferred, with or without charge, to any other department of the State or Commonwealth; or
  - (b) to be sold at public auction, by tender or by private contract; or
  - (c) to be destroyed, as specified by the CEO.
- (2) Fish forfeited to the Crown under the Act are to be dealt with as specified in regulation 148 in respect of fish seized under the Act.

- (3) The CEO is to specify which method referred to in subregulation (1) or regulation 148 is to apply in respect of a particular thing forfeited to the Crown.

*[Regulation 154 amended in Gazette 6 Jul 2007 p. 3389.]*

**155. Accounts prescribed (Act s. 221(2))**

For the purposes of section 221(2) of the Act, proceeds of the sale of any thing forfeited to the Crown under the Act are to be paid to the credit of —

- (a) the Fisheries Research and Development Fund<sup>4</sup> continued under section 238 of the Act, where the thing was forfeited in respect of an offence relating to aquaculture, commercial fishing, or processing; or
- (b) the Recreational Fishing Fund<sup>5</sup> established under section 239 of the Act in all other cases.

*[Regulation 155 amended in Gazette 30 May 2014 p. 1735.]*

**156. Provisions of regulations prescribed (Act s. 222(1))**

For the purposes of section 222(1) of the Act, the provisions of the regulations referred to in the Table to this regulation are prescribed provisions.

**Table**

Regulations 14(1), 14(3), 14(4), 16B, 16E(3C), 22, 31(2), 31(3), 31(4), 31A(1), 35, 38B, 38C, 38D(2), 38D(3), 38E, 38F, 38H, 38I(1), 38J, 38K, 38M, 38N(1), 38O(1), 41(1), 41(2A), 45(2), 55G(1), 55G(2), 56A, 64(5), 64AA(2), 113A(1), 113A(2), 113B(1), 121, 128O, 130 and 147A(2).

*[Regulation 156 amended in Gazette 21 Dec 1999 p. 6408; 29 Dec 2000 p. 7979; 29 Jun 2001 p. 3175; 14 Nov 2001 p. 5979; 29 Nov 2002 p. 5655; 1 Oct 2003 p. 4327; 28 Nov 2003 p. 4775; 23 Dec 2003 p. 5206; 4 Nov 2005 p. 5313; 11 Nov 2005 p. 5566; 22 Dec 2005 p. 6227; 10 Nov 2006 p. 4709; 4 Sep 2007 p. 4520; 29 Sep 2009 p. 3867; 27 Aug 2010 p. 4106; 1 Mar 2011 p. 672; 2 Aug 2011 p. 3168;*

**r. 157**

---

*29 Jan 2013 p. 312; 18 Jun 2013 p. 2297; 28 Jun 2013 p. 2893;  
27 Aug 2013 p. 4056; 30 May 2014 p. 1722 and 1736.]*

**157. Values prescribed (Act s. 222(4)(a), (b))**

- (1) For the purposes of section 222(4)(a) of the Act, the value per unit of weight of the fish is —
  - (a) for a fillet of finfish, \$30 per kg; or
  - (b) for a fin of a shark or ray removed from the fish trunk, \$120 per kg; or
  - (c) otherwise, the amount per kg of fish set out in Schedule 9 for fish of that kind.
- (2) For the purposes of section 222(4)(b) of the Act, the value per fish is —
  - (a) for a fin of a shark or ray removed from the fish trunk, \$24 per fin; or
  - (b) otherwise, the amount per fish set out in Schedule 9 for that kind of fish.

*[Regulation 157 inserted in Gazette 10 Nov 2006 p. 4709;  
amended in Gazette 29 Sep 2009 p. 3867.]*

**158. Offences prescribed (Act s. 224(1)(a))**

An offence against a provision referred to in the Table to this regulation is a prescribed offence under section 224(1)(a) of the Act.

**Table**

**Provisions of the Act**

Sections 43(3), 46, 47, 49, 74(1) and (2), 77, 82(1), 86, 88, 96, 112, 170(1), 171(1), 172, 173(1), 174(1), 175(1), 176, 189(2), 190(2), 191(5), 199, 200, 225(4) and (5) and 255(3).

**Provisions of these regulations**

Regulations 13, 16B, 18, 31A(1), 31A(2), 32(1), 35, 38, 55G(1), 55G(2), 55H(2), 63, 64, 64Q, 71(3), 117(1), 119(2), 125(2), 128MA(2), 128OA(2), 128O, 128P, 130(4), 145(1) and 176.

*[Regulation 158 amended in Gazette 29 Jun 2001 p. 3175; 14 Nov 2001 p. 5979; 29 Nov 2002 p. 5655; 11 Feb 2003 p. 412; 1 Oct 2003 p. 4328; 31 Oct 2003 p. 4562; 10 Nov 2006 p. 4709; 27 Aug 2010 p. 4106; 4 Dec 2012 p. 5920; 4 Sep 2013 p. 4179; 30 May 2014 p. 1736; 26 Aug 2014 p. 3084.]*

**159. Offences prescribed (Act s. 228(1))**

An offence against a provision set out in column 1 of Schedule 12 is a prescribed offence under section 228(1) of the Act.

**160. Infringement notice form prescribed (Act s. 229(1))**

An infringement notice under section 229(1) of the Act is to be in the form of Form 3.

**161. Withdrawal of infringement notice form prescribed (Act s. 231(1))**

A notice to be served under section 231(1) of the Act is to be in the form of Form 4.

**162. Modified penalties prescribed (Act s. 229(2))**

- (1) The modified penalty set out in column 2 of Schedule 12 opposite an offence referred to in column 1 is the prescribed modified penalty for that offence for the purposes of section 229(2) of the Act.
- (2) In Schedule 12 —  
*notional bag limit*, in relation to totally protected fish of a particular species, means the bag limit that applies to fish of that species that are not totally protected.

**r. 162**

---

*[Regulation 162 amended in Gazette 18 Jun 2013 p. 2297.]*



## **Part 16 — Financial provisions**

### **163. Times prescribed for special purpose audits (Act s. 240)**

The times for a special purpose audit to be carried out under section 240(6)(b) of the Act are within 2 months after the end of any financial year in which —

- (a) any money was paid to the industry body under section 240(5) of the Act; or
- (b) any moneys paid to the industry body under section 240(5) of the Act were expended by the body.

## **Part 17 — Miscellaneous**

### **Division 1 — Guidelines**

**164. Ways of publishing guidelines prescribed (Act s. 246 and 247)**

- (1) The CEO is to publish guidelines under section 246 or 247 of the Act by publishing notice in the *Gazette* or in a newspaper circulating daily in the State that the guidelines have been issued, amended or revoked and published by the Department and that copies are available to the public free of charge at the offices of the Department.
- (2) The CEO is to make copies of published guidelines available to the public free of charge at the offices of the Department.

*[Regulation 164 amended in Gazette 6 Jul 2007 p. 3389.]*

**165. Form of notice to attend inquiry etc. (Act s. 249(3))**

A notice under section 249(3)(a) of the Act is to be in the form of Form 5.

### **Division 2 — Exclusive licences**

**166. Applications for exclusive licences**

- (1) An application for the grant or renewal of an exclusive licence must be —
  - (a) made to the Minister in a form approved for that purpose by the CEO; and
  - (b) accompanied by the fee set out in item 13 of Part 2 of Schedule 1; and
  - (c) accompanied by any information that the Minister reasonably requires for a proper consideration of the application.

- (2) An applicant must provide the Minister with any further information that the Minister by notice in writing requires the applicant to provide in respect of an application.
- (3) An applicant must, if required to do so by the Minister, verify by statutory declaration any information contained in, or given in connection with, an application.
- (4) The Minister may refuse to consider an application if the application does not conform to a provision of this regulation or if the applicant has failed to comply with a provision of this regulation.

*[Regulation 166 amended in Gazette 6 Jul 2007 p. 3389;  
9 Jun 2009 p. 1911.]*

**167. Effect of exclusive licences**

- (1) An exclusive licence is granted and has effect subject to the Act and does not authorise the doing of anything in contravention of the Act.
- (2) The authority conferred by an exclusive licence is of no effect at any time when any of its conditions are being contravened.

**168. Form of exclusive licences**

An exclusive licence is to be in a form approved by the CEO.

*[Regulation 168 amended in Gazette 6 Jul 2007 p. 3389-90.]*

**169. Renewal after expiry of exclusive licences (Act s. 139)**

Section 139 of the Act applies in respect of the renewal of an exclusive licence as if that licence were an authorisation referred to in that section, except that the application is to be made to the Minister.

**170. Some draft exclusive licences to go before Parliament**

An exclusive licence is not to be granted in respect of an area that has a foreshore with a length greater than 120 km until

14 sitting days after a draft of the licence has been laid before each House of Parliament.

**171. Conditions of exclusive licences**

Subject to any terms or conditions to which an exclusive licence is subject under section 251(3) of the Act, every exclusive licence is subject to the following conditions —

- (a) that the fees or royalties (if any) that the licence holder is required to pay in relation to the licence are paid at the head office of the Department in Perth in the manner provided in the licence;
- (b) that if —
  - (i) any fees or royalties that the licence holder is required to pay in relation to the licence remain unpaid for 21 days after they become due; or
  - (ii) the licence holder fails to comply with any of these conditions or with any other terms or conditions relating to the licence to which the licence holder is subject; or
  - (iii) the Minister considers that it is in the public interest to do so,

the Minister may revoke the licence and, on the licence being revoked, all the interest of the licence holder, or any person claiming under the licence holder, in the licence terminates.

**172. Who can fish in areas the subject of exclusive licences**

- (1) Subject to subregulation (2), a person must not engage in fishing in an area that is the subject of an exclusive licence unless the person is authorised by the licence to do so.

Penalty: \$3 000.

- (2) Subregulation (1) does not apply to a person who takes fish for the purpose of personal consumption.

**Division 3 — Prohibition of activities that pollute waters**

**173. Notice prohibiting activities, form of (Act s. 255(1))**

A notice to be given by the Minister under section 255(1) of the Act is to be in the form of Form 6.

**174. Notice of variation or revocation, form of (Act s. 255(2)(c))**

A notice to be given by the Minister under section 255(2)(c) of the Act is to be in the form of Form 7.

*[175. Deleted in Gazette 30 Dec 2004 p. 6965.]*

**Division 4 — General**

**176. Non-endemic fish, approval to import into WA etc.**

- (1) A person must not bring into the State, or a particular area of the State, a live fish of a species not endemic to the State, or that area of the State, other than in accordance with —
  - (a) the written approval of the CEO; or
  - (b) the written authority of the CEO under subregulation (2); or
  - (c) an aquaculture licence.
- (2) An application for an authority under subregulation (1)(b) —
  - (a) is to be made to the CEO in a form approved for that purpose by the CEO; and
  - (b) is to be accompanied by the fee set out in item 15 of Part 2 of Schedule 1.
- (3) An approval or authority under subregulation (1) is subject to any conditions specified in the approval or authority by the CEO.
- (4) The CEO may vary or cancel a condition specified in an approval or authority under subregulation (1) by notice in writing given to the holder of the approval or authority.

- (5) The CEO may vary or cancel an approval or authority under subregulation (1) at any time by notice in writing given to the holder of the approval or authority.
- (6) A person must not contravene an approval or authority issued under subregulation (1).
- (7) A person who is in possession of a fish of any species of fish not endemic to the State, or the area of the State where the person is in possession of the fish, must destroy the fish if the fish is found to be infected with any disease, unless otherwise approved in writing by the CEO.
- (8) The species of fish listed in Schedule 10 are to be taken to be not endemic to the State for the purposes of the Act, but Schedule 10 is not a conclusive list of species of fish which are not endemic to the State for the purposes of the Act.  
Penalty: \$10 000.

*[Regulation 176 amended in Gazette 6 Jul 2007 p. 3389-90;  
9 Jun 2009 p. 1912.]*

**177.    Disease control at fish processing or aquaculture places**

- (1) A fisheries officer who has reasonable grounds to suspect that any fish at a place where fish processing or aquaculture is being carried on are diseased may, by notice in writing given to the holder of the relevant licence, require that person to carry out the treatment specified in the notice within the time specified in the notice.
- (2) A fisheries officer who has reasonable grounds to suspect that fish at a place where aquaculture is being carried on are affected by —
  - (a) a scheduled fish disease; or
  - (b) any disease which cannot be effectively treated at the place where the fish are; or
  - (c) a disease of such a nature that the officer's urgent action is required to prevent the spread of the disease,

may take, or require the holder of the relevant licence to take, such action as the officer thinks fit to destroy the fish affected and to eradicate the disease from the place.

- (3) Any costs incurred as a result of action taken by a fisheries officer under subsection (2) may be recovered by the CEO from the holder of the licence as a debt due.
- (4) The CEO may, by notice in writing given to the holder of an aquaculture licence, require that person to carry out such action as is specified in the notice for the prevention of any disease in fish at the place where aquaculture is carried out under the licence within the time specified in the notice.
- (5) A person must —
  - (a) comply with a notice given to the person under subregulation (1); and
  - (b) carry out any action required by a fisheries officer to be carried out by that person under subregulation (2); and
  - (c) comply with a notice given by the CEO under subregulation (4).

Penalty: \$10 000.

*[Regulation 177 amended in Gazette 6 Jul 2007 p. 3389-90; 24 Sep 2013 p. 4450.]*

**178. Fish for scientific purposes, authority to fish for**

- (1) Despite anything else in these regulations, a person may fish for fish for scientific purposes if that person has a written authority to do so issued by the CEO.
- (2) An application for an authority under subregulation (1) —
  - (a) is to be made to the CEO in a form approved for that purpose by the CEO; and
  - (b) is to be accompanied by the fee set out in item 14 of Part 2 of Schedule 1.

- (3) An authority under subregulation (1) is subject to any conditions specified in the authority by the CEO.
- (4) The CEO may vary or cancel a condition specified in an authority under subregulation (1) by notice in writing given to the holder of the authority.
- (5) The CEO may vary or cancel an authority at any time by notice in writing given to the holder of the authority.
- (6) A person must not contravene an authority issued under subregulation (1).

Penalty: \$3 000.

*[Regulation 178 amended in Gazette 6 Jul 2007 p. 3389-90;  
9 Jun 2009 p. 1912.]*

**179. Fish for genetic etc. analysis, approval to take etc.**

- (1) A person must not engage in any activity referred to in subregulation (2) other than in accordance with —
  - (a) the written approval of the CEO; or
  - (b) the written authority of the CEO under subregulation (3).
- (2) For the purposes of subregulation (1) the activities are —
  - (a) the taking of fish for genetic or chemical extraction or analysis; or
  - (b) the handling, delivering, receiving, storing, packaging, purchasing or selling of fish which the person has reasonable grounds to believe are to be used for genetic or chemical extraction or analysis.
- (3) An application for an authority under subregulation (1)(b) —
  - (a) is to be made to the CEO in a form approved for that purpose by the CEO; and
  - (b) is to be accompanied by the fee set out in item 18 of Part 2 of Schedule 1.



- (4) An approval or authority under subregulation (1) is subject to any conditions specified in the approval or authority by the CEO.
- (5) The CEO may vary or cancel a condition specified in an approval or authority under subregulation (1) by notice in writing given to the holder of the approval or authority.
- (6) The CEO may vary or cancel an approval or authority under subregulation (1) at any time by notice in writing given to the holder of the approval or authority.
- (7) A person must not contravene an approval or authority issued under subregulation (1).

Penalty: \$10 000.

*[Regulation 179 amended in Gazette 6 Jul 2007 p. 3389-90;  
9 Jun 2009 p. 1912.]*

**180. Categories of fish (Sch. 4)**

For the purposes of the Act, a species of fish referred to in Schedule 4 is a species of fish of the category referred to in the heading below which it appears.

*[Regulation 180 amended in Gazette 1 Oct 2003 p. 4328;  
4 Nov 2005 p. 5313.]*

**181A. Certain things are not personal property for purposes of *Personal Property Securities Act 2009* (Cwlth)**

In accordance with the *Personal Property Securities Act 2009* (Commonwealth) section 10 the definition of *licence* paragraph (d), the following rights, entitlements or authorities are declared not to be personal property for the purposes of that Act —

- (a) a fishing boat licence granted under regulation 118(1);
- (b) a carrier boat licence granted under regulation 120(1);
- (c) a commercial fishing licence granted under regulation 122;

**Fish Resources Management Regulations 1995**

**Part 17**            Miscellaneous

**Division 4**        General

**r. 181**

---

- (d) a recreational fishing licence granted under regulation 124(1);
- (e) a recreational (boat) fishing licence granted under regulation 124C;
- (f) a rock lobster pot licence granted under regulation 126;
- [(g) deleted]*
- (h) a fishing tour operator's licence granted under regulation 128J(1);
- (i) a restricted fishing tour operator's licence granted under regulation 128J(1a).

*[Regulation 181A inserted in Gazette 22 Nov 2011 p. 4848; amended in Gazette 30 May 2014 p. 1736.]*

**181. Fees and charges, reduction and waiver of**

The CEO may authorise the reduction, waiver or refund, in whole or in part, of any fee or charge provided for in these regulations or in a management plan if the CEO considers it appropriate to do so.

*[Regulation 181 amended in Gazette 26 Mar 1999 p. 1280 (disallowed in Gazette 25 Jun 1999 p. 2742); amended in Gazette 13 Aug 1999 p. 3827; 6 Jul 2007 p. 3389-90.]*

## Part 18 — Savings and transitional provisions

### 182. Limited entry fisheries under repealed Act (Act s. 74)

- (1) For the purposes of section 74 of the Act, a provision of a notice under section 32 of the repealed Act continued in effect under clause 9 of Schedule 3 of the Act as if it were a management plan which requires a person —

- (a) to do; or
- (b) not to do,

a specified thing is to be taken to be a provision the contravention of which is specified in the notice to be an offence.

*[(2) deleted]*

*[Regulation 182 amended in Gazette 23 May 2006 p. 1860.]*

### 183. Citation of notices

- (1) Each notice made under section 32 of the repealed Act referred to in column 1 of the Table to this regulation may be cited using the citation set out opposite the item in column 2 of that Table.
- (2) Those notices in force under section 32 of the repealed Act immediately before the commencement of these regulations not set out in column 1 of the Table to this regulation may be cited as if the words “Limited Entry Fishery Notice” were deleted from their citation and the word “Management Plan” were substituted.

#### Table

<i>South Coast Salmon Fishery Notice 1982</i>	<i>South Coast Salmon Management Plan 1982</i>
<i>South-West Coast Salmon Fishery Notice 1982</i>	<i>South-West Coast Salmon Management Plan 1982</i>

*[184, 185. Deleted in Gazette 23 May 2006 p. 1861.]*

**r. 186**

---

**186. Certain notices under repealed Act continued as orders  
(Act s. 43)**

A notice under section 9, 10, 11 or 38 of the repealed Act in force immediately before the commencement of these regulations continues in force on that commencement, and may be amended or revoked, as if the notice were an order made under section 43 of the Act and as if any reference in the notice to the Director were a reference to the CEO.

*[Regulation 186 amended in Gazette 6 Jul 2007 p. 3389-90.]*

**Schedule 1 — Fees***[Heading inserted in Gazette 9 Jun 2009 p. 1912.]***Part 1 — General fees***[Heading inserted in Gazette 9 Jun 2009 p. 1912.]***Table**

<b>Fees</b>	<b>\$</b>
1. Application for an exemption under section 7(4) —	
(a) to the Minister, for any purpose (as provided by section 7(2) of the Act)	2 335.00
(b) to the CEO, for the purposes of scientific research (as provided by section 7(3)(a)), or for educational and community awareness programmes (as provided by section 7(3)(g))	305.00
(c) to the CEO, for one of the purposes provided by section 7(3)(b), (c), (d), (e), or (f)	1 231.00
2. Copy of entry on, or extract from, the register (reg. 114(2)(a))	33.00
3. Access to the register in electronic form (reg. 114(2)(b))	33.00
4. Application for replacement authorisation (reg. 129)	20.00

*[Part 1 inserted in Gazette 9 Jun 2009 p. 1912; amended in Gazette 6 May 2011 p. 1609-10.]*

**Part 2 — Application fees**

[reg. 135]

*[Heading inserted in Gazette 9 Jun 2009 p. 1913.]*

<b>Fee</b>	<b>\$</b>
1. Fishing boat licence, grant or renewal (reg. 118)	87.00
For transfer	477.00
For variation	477.00
2. Carrier boat licence, grant or renewal (reg. 120)	87.00
For transfer	477.00
For variation	477.00
3. Commercial fishing licence, grant or renewal (reg. 122)	87.00
<i>[4. deleted]</i>	
5. Rock lobster pot licence, grant or renewal (reg. 126)	87.00
For transfer	327.00
6. Application for authority to use another boat (reg. 132)	477.00
7. Grant of permit under section 80 of the Act	465.00
8. Fish processor's licence under section 83 of the Act	465.00
For renewal	91.00
For transfer	544.00
For variation (other than as set out in item 9)	544.00
9. Variation of fish processor's licence to change place at which fish may be processed under the licence	544.00

**Fish Resources Management Regulations 1995****Fees      Schedule 1**  
**Application fees      Part 2**

---

<b>Fee</b>	<b>\$</b>
10. Aquaculture lease, grant or renewal (reg. 67)	2 461.00
11. Aquaculture licence under section 92 of the Act —	
In respect of freehold land	171.00
In respect of non-freehold land	771.00
For renewal	87.00
For transfer (freehold land)	171.00
For transfer (non-freehold land)	567.00
For variation (freehold land)	171.00
For variation (non-freehold land)	567.00
12. Authorisation under section 66 of the Act	329.00
For renewal	87.00
For transfer	477.00
For variation	477.00
13. Exclusive licence, grant or renewal (reg. 166)	771.00
14. Authority to take fish for scientific purposes (reg. 178)	87.00
15. Authority to bring in non-endemic fish (reg. 176)	153.00
16. Temporary transfer of part entitlements under section 141 of the Act	153.00

**Fish Resources Management Regulations 1995****Schedule 1 Fees****Part 2 Application fees**

---

<b>Fee</b>	<b>\$</b>
17. Register — notation under section 127 of the Act	153.00
Register — variation under section 131 of the Act	153.00
Register — removal of record under section 131 of the Act	153.00
18. Authority to take or handle fish for genetic or chemical extraction or analysis (reg. 179)	771.00
19. Restricted fishing tour operator's licence (reg. 128J)	69.00
For renewal	74.00
For transfer	414.00
For variation	414.00
20. Fishing tour operator's licence (reg. 128J)	69.00
For renewal	74.00
For transfer	414.00
For variation	414.00

*[Part 2 inserted in Gazette 9 Jun 2009 p. 1913-14; amended in Gazette 12 Feb 2010 p. 586; 6 May 2011 p. 1610-11; 30 May 2014 p. 1736.]*



**Part 3 — Fees for the grant or renewal of authorisations**

[reg. 137]

*[Heading inserted in Gazette 9 Jun 2009 p. 1915.]*

Fee	\$
1. Fish processor's licence Types of processing establishments —	
(a) processing establishment that is erected on land and that is used for processing either rock lobsters or prawns	862.00
(b) processing establishment that is erected on land and that is used for processing both rock lobsters and prawns	1 581.00
(c) processing establishment that is erected on land and that is used for processing any fish including rock lobsters and prawns	2 125.00
(d) processing establishment that is erected on land and that is used for processing any fish including either rock lobsters or prawns	1 280.00
(e) processing establishment that is erected on land and that is used for processing any fish other than rock lobsters and prawns	420.00
(f) seagoing processing establishment that is used solely for processing fish including rock lobsters and prawns taken by it	420.00
(g) seagoing processing establishment that is used solely for processing fish including rock lobsters and prawns taken by other boats	420.00
2. Aquaculture licence	
(a) any licence other than a licence referred to in paragraph (b)	363.00

**Fish Resources Management Regulations 1995****Schedule 1** Fees**Part 3** Fees for the grant or renewal of authorisations

<b>Fee</b>	<b>\$</b>
(b) a licence that authorises the aquaculture of marron only and is subject to the condition that the sale of the marron is prohibited unless —  (i) the marron are of a length not less than 76 mm; and	
(ii) the majority of the marron are sold to persons who hold an aquaculture licence or a fish processor's licence; and  (iii) no more than 100 kg of marron in total is sold to persons who do not hold an aquaculture licence or a fish processor's licence during the period for which the licence remains in force	No fee
<b>3. Managed fishery licence fees</b>	
(1) Abalone Managed Fishery, the sum obtained by multiplying the total kg of entitlement conferred by the licence (but excluding any entitlement transferred to or from the licence under section 141 of the Act) by the fee for each kg, as follows —	
(a) for greenlip abalone, per kg	5.98
(b) for brownlip abalone, per kg	5.98
(c) for Roe's abalone, per kg	1.32
(2) Abrolhos Islands and Mid West Trawl Managed Fishery, per licence	100.00
(3) Broome Prawn Managed Fishery, per licence	963.00
(4) Cockburn Sound (Crab) Managed Fishery, per pot	26.34
(5) Cockburn Sound (Fish Net) Managed Fishery, per licence	4 289.00

**Fish Resources Management Regulations 1995**

Fees  
Fees for the grant or renewal of authorisations

**Schedule 1  
Part 3**

<b>Fee</b>	<b>\$</b>
(6) Cockburn Sound (Line and Pot) Managed Fishery, per licence	1 165.00
(7) Cockburn Sound (Mussel) Managed Fishery, per licence	122.00
(8) Esperance Rock Lobster Managed Fishery, per pot	104.67
(9) Exmouth Gulf Prawn Managed Fishery, per licence	27 031.00
(10) Gascoyne Demersal Scalefish Managed Fishery, per unit	31.55
(11) Kimberley Gillnet and Barramundi Managed Fishery, per licence	4 905.00
(12) Kimberley Prawn Managed Fishery —	
(a) for a Class 1 licence	1 001.00
(b) for a Class 2 licence	1 001.00
(c) for a Class 3 licence	5 000.00
(13) Marine Aquarium Fish Managed Fishery, per licence	955.00
(14) Nickol Bay Prawn Managed Fishery, per licence	3 575.00
(15) Northern Demersal Scalefish Fishery —	
(a) for an Area 1 licence	268.00
(b) for an Area 2 licence, per unit of entitlement, in zone A	42.87
(c) for an Area 2 licence, per unit of entitlement, in zone B	219.72

**Fish Resources Management Regulations 1995****Schedule 1** Fees**Part 3** Fees for the grant or renewal of authorisations

<b>Fee</b>	<b>\$</b>
(d) for an Area 2 licence, per unit of entitlement, in zone C	5.36
(16) Onslow Prawn Managed Fishery —	
(a) for an A class licence	1 860.00
(b) for a B class licence	32.00
(c) for a C class licence	32.00
(d) for a D class licence	32.00
(17) Pilbara Fish Trawl Interim Managed Fishery, per fish trawl unit	11.26
(18) Pilbara Trap Managed Fishery, per trap unit	26.78
(19) Shark Bay Beach Seine and Mesh Net Managed Fishery, per licence	5 370.00
(20) Shark Bay Prawn Managed Fishery, per licence	70 720.00
(21) Shark Bay Scallop Managed Fishery —	
(a) for a class A boat, per boat	100.00
(b) for a class B boat, per boat	785.00
(22) South Coast Estuarine Managed Fishery, per licence	2 667.00
(23) South Coast Purse Seine Managed Fishery, the sum obtained by multiplying the number of units of entitlement determined in accordance with that management plan, conferred by the licence by the fee for each unit as follows —	
(a) for zone 1	189.37
(b) for zone 2	12.09

**Fish Resources Management Regulations 1995**

Fees      **Schedule 1**  
 Fees for the grant or renewal of authorisations      **Part 3**

<b>Fee</b>	<b>\$</b>
(c) for zone 3	111.36
(d) for zone 4	176.86
(24) South Coast Salmon Managed Fishery, per licence	241.00
(25) South West Coast Salmon Managed Fishery, per licence	302.00
(26) South West Trawl Managed Fishery, per licence	4 963.00
(27) Specimen Shell Managed Fishery, per licence	1 030.00
(28) Warnbro Sound (Crab) Managed Fishery, per licence	1 083.00
(29) West Coast (Beach Bait Fish Net) Managed Fishery, per licence	654.00
(30) West Coast Deep Sea Crustacean Managed Fishery —	
(a) for class A units, per unit	19.19
(b) for class B units, per unit	4.21
(31) West Coast Demersal Gillnet and Demersal Longline Interim Managed Fishery, per unit	2.27
(32) West Coast Purse Seine Managed Fishery, per licence	673.00
(33) West Coast Rock Lobster Managed Fishery —	
(a) for zone A units, per unit	10.40
(b) for zone B units, per unit	17.45
(c) for zone C units, per unit	16.24
(34) Windy Harbour-Augusta Rock Lobster Managed	

**Fish Resources Management Regulations 1995**

**Schedule 1** Fees

**Part 3** Fees for the grant or renewal of authorisations

---

<b>Fee</b>	<b>\$</b>
Fishery, per pot	2.53
<i>[(4) deleted]</i>	
5. Fishing tour operator's licence (r. 128J(1)) —	
(a) if the nominated maximum number of passengers participating in a fishing tour conducted under the licence is —	
(i) 5 passengers or fewer	1 200.00
(ii) between 6 and 10 passengers	1 700.00
(iii) between 11 and 15 passengers	2 200.00
(iv) between 16 and 20 passengers	2 700.00
(v) between 21 and 25 passengers	3 200.00
(vi) 26 passengers or more	3 700.00
(b) in addition to the fee determined under item 5(a), if the licence authorises the conduct of a fishing tour in more than one zone, for each additional zone	700.00

**Fish Resources Management Regulations 1995**

Fees  
Fees for the grant or renewal of authorisations

**Schedule 1  
Part 3**

Fee	\$
(c) in addition to the fee determined under item 5(a), if the licence is varied to increase the aggregate maximum surveyed passenger carrying capacity of all of the boats that may be used to conduct a fishing tour under the licence	The amount that is the difference between the fee for the licence before the variation and the fee determined under item 5(a) for the licence as varied
6A. Restricted fishing tour operator's licence (r. 128J(2)) —	
(a) for all restricted fishing tour operator's licences	500.00
(b) in addition to the fee specified in item 6A(a), if the licence authorises the conduct of a fishing tour in more than one zone, for each additional zone	500.00
6. Fishing boat licence Types of boat —	
(1) a boat 6.5 m or longer	315.00
(2) a boat shorter than 6.5 m	85.00
7. Tag authorising the possession of one pink snapper in the Freycinet Estuary	10.00
8. Recreational fishing licence (r. 124) —	
(a) fishing for rock lobster	40.00
(b) fishing for marron	40.00

**Fish Resources Management Regulations 1995**

**Schedule 1 Fees**

**Part 3 Fees for the grant or renewal of authorisations**

---

<b>Fee</b>	<b>\$</b>
(c) fishing for abalone	40.00
(d) fishing for all freshwater fish (other than crustaceans) in waters south of 29° south latitude above the tidal influence including all lakes, dams, rivers and their tributaries	40.00
(e) fishing by means of a fishing net	40.00
9. Recreational (boat) fishing licence (r. 124C)	30.00

*[Part 3 inserted in Gazette 9 Jun 2009 p. 1915-20; amended in Gazette 10 Sep 2009 p. 3539; 12 Feb 2010 p. 586-7; 28 May 2010 p. 2384-5; 27 Aug 2010 p. 4106; 10 Sep 2010 p. 4347; 2 Dec 2010 p. 6031-4; 6 May 2011 p. 1611-12; 24 Aug 2011 p. 3406-8; 9 Sep 2011 p. 3683; 17 Oct 2012 p. 4979-80; 19 Oct 2012 p. 5017-20; 2 Nov 2012 p. 5277-8; 18 Dec 2012 p. 6593; 4 Sep 2013 p. 4180-3; 15 Nov 2013 p. 5238; 19 Nov 2013 p. 5283; 30 May 2014 p. 1731-2 and 1736; 12 Aug 2014 p. 2903-7; 31 Oct 2014 p. 4199-200.]*



## **Schedule 2 — Protected fish**

[s. 46, 47 and 48A and r. 10]

*[Heading inserted in Gazette 14 Sep 2012 p. 4375.]*

### **Part 1 — Commercially protected fish**

All freshwater aquatic organisms other than sooty grunter and catfish of the Family Ariidae.

Billfish (marlins, sailfish and spearfish).

Oyster of the Families Ostreidae and Pteriidae.

Sharks and Rays, other than sharks or rays that are totally protected fish.

Western rock lobster less than 77 mm in length.

*[Part 1 amended in Gazette 12 Sep 1997 p. 5154; 5 Dec 1997 p. 7123; 1 Oct 2003 p. 4344; 10 Nov 2006 p. 4709; 4 Sep 2007 p. 4520; 18 Nov 2011 p. 4810.]*

### **Part 2 — Totally protected fish**

#### **Division 1 — Certain reproducing crustaceans**

Female crab with eggs or spawn attached beneath its body.

Female marron with eggs, spawn, larvae or young marron attached beneath its body.

Female rock lobster with eggs or spawn attached beneath its body.

Setose or tarspot western rock lobster —

- (a) taken from; or
- (b) in the possession of, or consigned by, a person on a boat on;  
or
- (c) brought onto land from,

waters south of 21° 44' south latitude and west of 116° east longitude.

**Fish Resources Management Regulations 1995**

**Schedule 2** Protected fish

**Part 2** Totally protected fish

---

In this Division —

**setose** means a female rock lobster that has fine hair-like filaments (*ovigerous setae*) —

- (a) for the attachment of eggs on the branched structures (*biramous endopodites*) forming part of the swimmerets (*pleopods*) underneath its tail; or
- (b) that, although not capable of the attachment of eggs as described in paragraph (a), are in the process of lengthening as part of the development of the rock lobster to sexual maturity;

**tarspot** means a female rock lobster that has a black putty-like mass (spermatophoric mass) attached to the underside of the carapace (ventral sternal plate) between its hindmost (5th) pair of walking legs.

[Division 1 amended in Gazette 22 Dec 1995 p. 6169; 30 Sep 1997 p. 5418; 7 Jul 1998 p. 3614; 8 Sep 2000 p. 5187-8; 4 Nov 2005 p. 5313.]

**Division 2 — Miscellaneous**

Abalone in the waters or land between 31° 59.48' south latitude (the main Cottesloe Groyne) and 32° 03.15' south latitude (Rous Head) and —

- (a) within 800 m of, and on the seaward side of, the high water mark; or
- (b) within 200 m of, and on the landward side of, the high water mark.

Cod in Rowley Shoals Marine Park.

Coral of the Order Scleractinia in any waters within 3 000 m in any direction of the service jetty near the end of Port Street in Port Gregory.

Fish of Class Anthozoa and Class Hydrozoa in Rowley Shoals Marine Park.

Great White Shark.

Groper, Queensland.

Humphead Maori Wrasse.

Live coral of the Order Scleractinia in the waters bounded by a line commencing from the intersection of 27° 30' south latitude and 112° 50' east longitude and extending in an easterly direction to the intersection of 27° 30' south latitude and 113° 37' east longitude; thence southeasterly to the intersection of 28° 45' south latitude and 114° 09' 52.18" east longitude; thence southeasterly to the intersection of 29° 30' south latitude and 114° 30' east longitude; thence west to 112° 50' east longitude; thence north to the starting point.

Leafy Seadragon.

Molluscs, other than cuttlefish, squid and octopus, in Rowley Shoals Marine Park.

Potato Cod.

Rays in the waters bounded by a line commencing north-east of White Cliff Point at the intersection of 34° 13.382' south latitude and 115° 1.470' east longitude; thence generally north-westerly along the geodesic to the intersection with 34° 13.283' south latitude and 115° 1.408' east longitude; thence generally north-easterly to the intersection of 34° 13.062' south latitude and 115° 1.763' east longitude; thence generally south-easterly to the intersection of 34° 13.164' south latitude and 115° 1.826' east longitude.

Rock Lobster tail weighing less than 140 g.

Sawfish.

Shark, Speartooth.

Shark, Whaler —

(a) taken from the waters of —

(i) the South Coast Region; or

(ii) the West Coast Region;

and

(b) with an interdorsal fin length of 70 cm or greater.

Weedy Seadragon.

Whale Shark.

Wrasse in Rowley Shoals Marine Park.

In this Division —

***interdorsal fin length*** means the distance between the first and second dorsal fins measured —

- (a) from —
  - (i) the first dorsal fin origin; or
  - (ii) if all or part of that fin has been removed so that point of origin cannot be ascertained, the anterior end of the cut made to remove the fin or that part of the fin;
- (b) to —
  - (i) the second dorsal fin insertion; or
  - (ii) if all or part of that fin has been removed so that point of insertion cannot be ascertained, the posterior end of the cut made to remove the fin or that part of the fin;

***Rowley Shoals Marine Park*** means all waters reserved under the *Conservation and Land Management Act 1984* section 13 as Class “A” Marine Reserve No. 3, Rowley Shoals Marine Park.

*[Division 2 amended in Gazette 5 Dec 1997 p. 7123; 19 Jun 1998 p. 3264; 13 Aug 1999 p. 3827; 28 Nov 2003 p. 4776; 22 Dec 2005 p. 6228; 13 Feb 2009 p. 299; 24 Aug 2011 p. 3408; 24 Feb 2012 p. 802.]*

### **Division 3 — Marine or fluvio-marine fish**

#### **Subdivision 1 — Protected by reference to species, area and period**

*[Heading inserted in Gazette 28 Feb 2003 p. 662.]*

#### **1. Pink Snapper**

Pink Snapper —

- (a) taken or brought onto land from the waters of the Shark Bay eastern gulf during the period beginning on 1 May in a year and ending on 31 July in that year; or

- (b) taken or brought onto land from the waters of the Freycinet Estuary during the period beginning on 15 August in a year and ending on 30 September in that year.

*[Clause 1 inserted in Gazette 15 Sep 2005 p. 4309-10; amended in Gazette 4 Nov 2005 p. 5313; 7 Mar 2006 p. 975.]*

**2. Baldchin Groper**

- (1) Baldchin Groper taken or brought onto land from, or in the possession of a person on, the Abrolhos Islands Fish Habitat Protection Area during the period beginning on 1 November in a year and ending on 31 January in the following year.

*[(2) deleted]*

*[Clause 2 inserted in Gazette 1 Oct 2003 p. 4329; amended in Gazette 4 Nov 2005 p. 5313; 29 May 2008 p. 2058; 19 Dec 2008 p. 5363; 30 May 2014 p. 1722.]*

**3. Cobbler**

Cobbler taken or brought onto land from the waters of the Swan or Canning Rivers on or before 30 June 2017.

*[Clause 3 inserted in Gazette 6 Jul 2007 p. 3388.]*

**4. Blue Groper**

- (1) Blue Groper —
- (a) taken or brought onto land from the waters of the Rottnest Island Reserve; or
  - (b) in the possession of a person on the Rottnest Island Reserve.

- (2) In subclause (1) —

***Rottnest Island Reserve*** has the meaning given in the *Rottnest Island Authority Act 1987* section 4.

*[Clause 4 inserted in Gazette 29 May 2008 p. 2058-9.]*

**Fish Resources Management Regulations 1995****Schedule 2** Protected fish**Part 2** Totally protected fish**Subdivision 2 — Protected by reference to species length or other factors**

*[Heading inserted in Gazette 28 Feb 2003 p. 662; amended in Gazette 1 Oct 2003 p. 4329.]*

<b>Class of fish</b>	<b>If of a length less than the length specified in respect of each class of fish (mm)</b>
Amberjack .....	600
Barramundi .....	550
Bream, Black .....	250
Bream, Fingermark .....	300
Bream, Northwest Black .....	250
Bream, Yellowfin .....	300
Cobbler (Estuary Catfish) when taken or brought onto land other than from waters, and before the date, referred to in Subdivision 1 item 3 —	
(a) when taken by the holder of a commercial fishing licence (partial length) .....	320
(b) in any other case (total length) .....	430
Cobia .....	750
Cod, Breaksea .....	300
Cod, Estuary .....	400
Coral Trout .....	450
Dhufish, West Australian .....	500
Dolphinfish (Mahi Mahi) .....	500
Emperor, Blue-lined .....	320
Emperor, Red (Government Bream) .....	410
Emperor, Spangled .....	410
Flathead, Bar-tailed .....	300
Flathead, Blue-spotted .....	300
Flathead, Long-spined .....	300
Flathead, Marbled .....	300
Flounder .....	250
Groper, Baldchin .....	400
Groper, Blue .....	500
Javelinfish and Sweetlips .....	300
Kingfish (Yellowtail) .....	600
Leatherjacket .....	250

**Fish Resources Management Regulations 1995**

Protected fish      **Schedule 2**  
 Totally protected fish      **Part 2**

<b>Class of fish</b>	<b>If of a length less than the length specified in respect of each class of fish (mm)</b>
Mackerel, Australian Spotted .....	500
Mackerel, Broad-barred Spanish .....	750
Mackerel, Narrow-barred Spanish .....	900
Mackerel, Queensland School .....	500
Mackerel, Shark .....	500
Mackerel, Wahoo .....	900
Mangrove Jack .....	300
Mulloway, Northern .....	700
Mulloway (River Kingfish) .....	500
Pike, Long-finned .....	300
Salmon, Australian .....	300
Samson Fish (Sea Kingfish) .....	600
Sea Perch, Stripey .....	300
Snapper, Northwest .....	280
Snapper, Pink —	
(a) when taken or brought onto land from the waters of the West Coast Region that are south of 31° 00' south latitude .....	500
(b) when taken or brought onto land from the waters of the Shark Bay western gulf or from the waters of the Shark Bay eastern gulf (other than during a relevant period referred to in Subdivision 1 item 1) .....	500
(c) in any other case .....	410
Snapper, Queen (Blue Morwong) .....	410
Snapper, Red (Redfish) .....	300
Snook .....	300
Swallowtail .....	300
Tailor .....	300
Tarwhine (Silver Bream) .....	250
Threadfin, Giant .....	450
Trevally, Silver (Skipjack) .....	250
Tripletail .....	300
Tuskfish, Blackspot .....	400
Tuskfish, Blue .....	400

**Fish Resources Management Regulations 1995**

**Schedule 2** Protected fish

**Part 2** Totally protected fish

---

<b>Class of fish</b>	<b>If of a length less than the length specified in respect of each class of fish (mm)</b>
Whiting, King George (Spotted) .....	280

---

<b>Class of fish</b>	<b>If of a length greater than the length specified (mm)</b>
Snapper, Pink, when taken or brought onto land from the waters of the Shark Bay western gulf or from the waters of the Shark Bay eastern gulf (other than during a relevant period referred to in Subdivision 1 item 1)	700

*[Subdivision 2 amended in Gazette 30 Aug 1996 p. 4320; 4 Jul 1997 p. 3476-7; 12 Sep 1997 p. 5154; 5 Dec 1997 p. 7123; 7 Jul 1998 p. 3614; 21 Dec 1999 p. 6410; 25 Aug 2000 p. 4905; 26 Feb 2002 p. 786; 28 Feb 2003 p. 662; 7 Mar 2003 p. 747; 1 Oct 2003 p. 6330-1; 29 Jun 2004 p. 2523; 4 Nov 2005 p. 5314; 22 Dec 2005 p. 6228-9; 6 Jul 2007 p. 3388; 4 Sep 2007 p. 4520; 19 Dec 2008 p. 5363; 27 Mar 2009 p. 922; 8 Dec 2009 p. 4996; 29 Mar 2011 p. 1151-3; 29 Jan 2013 p. 312; 30 May 2014 p. 1722-3.]*

**Division 4 — Freshwater fish**

---

<b>Class of fish</b>	<b>If of a length less than the length specified in respect of each class of fish (mm)</b>
Grunter, Sooty .....	250
Trout, Brown .....	300
Trout, Rainbow .....	300

*[Division 4 amended in Gazette 22 Dec 2005 p. 6229.]*



**Division 5 — Crustaceans, other than those listed in Division 1**

<b>Class of fish</b>	<b>If of a length less than the length specified in respect of each class of fish (mm)</b>
Crab, Blue Manna —	
(a) when taken by the holder of a commercial fishing licence from the waters of Geographie Bay south of a line drawn from the intersection of 33° 31.8' south latitude and 115° 0.26' east longitude (north west tip of Cape Naturaliste) to the intersection of 33° 18.074' south latitude and 115° 38.765' east longitude (McKenna Point Lighthouse) .....	128
(b) in any other case .....	127
Crab, Champagne .....	92
Crab, Crystal .....	120
Crab, Giant .....	140
Crab, Mud (Brown) .....	120
Crab, Mud (Green) .....	150
Marron —	
(a) when taken from marron trophy waters .....	90
(b) in any other case .....	80
Rock Lobster, Southern .....	98.5
Rock Lobster, Tropical .....	76
Rock Lobster, Western .....	76
	<b>If of a length greater than the length specified in respect of each class of fish (mm)</b>
<b>Class of fish</b>	
Rock Lobster, Western, female —	
(a) taken from; or	
(b) in the possession of, or consigned by, a person on a boat on; or	
(c) brought ashore from, the waters between 30° and 34° 24' south latitude but excluding all waters on the south coast which are east of 115° 08.091' east longitude .....	105

**Fish Resources Management Regulations 1995**

**Schedule 2** Protected fish

**Part 2** Totally protected fish

<b>Class of fish</b>	<b>If of a length greater than the length specified in respect of each class of fish (mm)</b>
Rock Lobster, Western, female — (a) taken from; or (b) in the possession of a person on a boat moored or anchored in; or (c) brought ashore from, the waters between 21° 44' and 30° south latitude .....	95
Rock Lobster, Western, female — (a) taken; or (b) brought ashore, from the waters of the Windy Harbour-Augusta Rock Lobster Managed Fishery (as defined in the <i>Windy Harbour-Augusta Rock Lobster Management Plan 1987</i> ) otherwise than in accordance with the appropriate managed fishery licence .....	115

*[Division 5 amended in Gazette 12 Sep 1997 p. 5154; 30 Sep 1997 p. 5418; 15 Jan 1999 p. 112; 4 Jun 1999 p. 2271; 24 Oct 2000 p. 5965; 13 Dec 2002 p. 5798; 31 Oct 2003 p. 4563; 22 Dec 2005 p. 6229 (correction in Gazette 9 Jun 2006 p. 2030); 29 Dec 2006 p. 5891; 13 Nov 2007 p. 5692; 13 Mar 2009 p. 760-1; 5 Nov 2009 p. 4413; 18 Nov 2011 p. 4810; 24 Feb 2012 p. 802.]*

**Division 6 — Molluscs**

<b>Class of fish</b>	<b>If of a length less than the length specified in respect of each class of fish (mm)</b>
Abalone, Brownlip .....	140
Abalone, Greenlip .....	140
Abalone, Roe's .....	60
Trochus .....	65

**Part 3 — Recreationally protected fish**

*[Heading inserted in Gazette 14 Sep 2012 p. 4375.]*

Barramundi in excess of 800 mm in length.

Estuary cod in excess of 30 kg weight or 1000 mm in length.

Malabar cod in excess of 30 kg weight or 1000 mm in length.

*[Part 3 inserted in Gazette 14 Sep 2012 p. 4375; amended in Gazette 29 Jan 2013 p. 312.]*

**Schedule 3**

[Pt. 4B]

*[Heading inserted in Gazette 29 Jan 2013 p. 313.]*

**Bag limits**

*[Heading inserted in Gazette 29 Jan 2013 p. 313.]*

**Part 1 — Bag limits — demersal finfish**

*[Heading inserted in Gazette 29 Jan 2013 p. 313.]*

**Division 1 — Regions other than West Coast region**

[r. 65A]

*[Heading inserted in Gazette 29 Jan 2013 p. 313.]*

<b>Fish</b>	<b>Species bag limit for one day</b>	<b>Grouped bag limit of all species of demersal finfish for one day</b>
Barramundi cod .....	3	5 (excluding Snapper, Red (Redfish) and Swallowtail in South Coast region)
Boarfish .....	3	
Cod, all species except Chinaman Cod, Coral Trout and Coronation Trout.....	3	
Coral Trout .....	1	
Coronation Trout .....	1	
Dhufish, West Australian .....	1	
Dory, John and Mirror.....	3	
Emperor and Seabream, all species except Emperor, Blue-lined .....	3	
Emperor, Blue-lined .....	5	
Foxfish, Western and Pigfish .....	3	
Groper, Baldchin and Tuskfish .....	3	
Groper, Western Blue .....	1	
Hapuka, Bass Groper and Trevalla .....	3	
Pearl Perch .....	3	

**Fish Resources Management Regulations 1995**

Bag limits      **Schedule 3**

Bag limits — demersal finfish      **Part 1**

<b>Fish</b>	<b>Species bag limit for one day</b>	<b>Grouped bag limit of all species of demersal finfish for one day</b>
Sea Perch, Tropical, and Goldband Snapper, all species except Mangrove Jack, Fingermark bream and Stripey Seaperch .....	3	
Snapper, Pink, except in the waters of the Shark Bay western gulf or the waters of the Shark Bay eastern gulf .....	3	
Snapper, Pink, in the waters of the Shark Bay western gulf or the waters of the Shark Bay eastern gulf .....	2	
Snapper, Queen .....	3	
Snapper, Red (Redfish) and Swallowtail in South Coast region .....	8	

*[Division 1 inserted in Gazette 29 Jan 2013 p. 313-14; amended in Gazette 27 Aug 2013 p. 4057; 30 May 2014 p. 1723.]*

**Fish Resources Management Regulations 1995**

**Schedule 3** Bag limits

**Part 1** Bag limits — demersal finfish

**Division 2 — West Coast region**

[r. 65B]

*[Heading inserted in Gazette 29 Jan 2013 p. 314.]*

<b>Fish</b>	<b>Species bag limit for one day</b>	<b>Grouped bag limit of all species of demersal finfish for one day</b>
Boarfish .....	2	2
Cod, all species except Coral Trout and Coronation Trout .....	2	
Coral Trout and Coronation Trout .....	1	
Dhufish, West Australian .....	1	
Dory, John and Mirror	2	
Emperor and Seabream, all species .....	2	
Foxfish, Western and Pigfish .....	2	
Groper, Baldchin and Tuskfish .....	2	
Groper, Blue .....	1	
Hapuka, Trevalla, Bass Groper and Grey Banded Rock Cod .....	2	
Sea Perch, Tropical, all species except Mangrove Jack .....	2	
Snapper, Pink, .....	2	
Snapper, Queen .....	2	
Snapper, Red (Redfish) and Swallowtail.....	2	

*[Division 2 inserted in Gazette 29 Jan 2013 p. 314; amended in Gazette 28 Jun 2013 p. 2893.]*

**Part 2 — Bag limits — large pelagic fish**

[r. 65C]

*[Heading inserted in Gazette 29 Jan 2013 p. 315.]*

<b>Fish</b>	<b>Species bag limit for one day</b>	<b>Grouped bag limit of all species of large pelagic finfish for one day</b>
Amberjack, Samson Fish and Yellowtail Kingfish .....	3	3
Barracouta (Gemfish) .....	3	
Barracuda .....	3	
Billfish (Marlin, Sailfish) and Swordfish .....	1	
Cobia .....	3	
Dolphinfish (Mahi Mahi) .....	3	
Mackerel (Broad-barred Spanish, Queensland School, Shark, Australian Spotted, Narrow-barred Spanish and Wahoo) .....	3	
Sharks and rays .....	3	
Trevally, Giant and Golden .....	3	
Tuna (Bigeye, Mackerel, Longtail (Northern Bluefin), Skipjack, Southern Bluefin, Yellowfin and Dogtooth) .....	3	

*[Part 2 inserted in Gazette 29 Jan 2013 p. 315; amended in Gazette 30 May 2014 p. 1723.]*

**Fish Resources Management Regulations 1995**

Schedule 3 Bag limits

Part 3 Bag limits — nearshore or estuarine finfish

**Part 3 — Bag limits — nearshore or estuarine finfish**

[r. 65D]

*[Heading inserted in Gazette 29 Jan 2013 p. 315.]*

<b>Fish</b>	<b>Species bag limit for one day</b>	<b>Grouped bag limit of all species of nearshore or estuarine finfish for one day</b>
Barramundi .....	2	16
Bonitos, all species and Tuna, Albacore .....	8	
Bream, Black, Silver (Tarwhine), Northwest Black and Yellowfin .....	6 (only 2 Black Bream taken from the waters of the Swan and Canning Rivers may be over 400 mm in length)	
Catfish and Cobbler .....	8	
Cod, Chinaman (Charlie Court) .....	4	
Dart .....	8	
Flathead .....	8	
Flounder .....	8	
Javelinfish and Sweetlips .....	8	
Leatherjacket .....	8	
Mangrove Jack .....	2	
Mulloway (River Kingfish) .....	2	
Mulloway, Northern .....	2	
Pike, Long-finned .....	8	
Salmon, Australian .....	4	
Sea Perch, Stripey and Bream, Fingermark ..	4	
Snook and Pike, Striped Sea .....	8	
Sweep, Sea .....	4	



<b>Fish</b>	<b>Species bag limit for one day</b>	<b>Grouped bag limit of all species of nearshore or estuarine finfish for one day</b>
Tailor .....	8 (only 2 of which may be over 500 mm in length)	
Threadfin, Giant .....	2	
Threadfin, other species .....	4	
Trevally and Queenfish, all species except Giant and Golden Trevally, Needleskin Queenfish, and Yellowtail Scad .....	8	
Tripletail .....	2	
Whiting, King George (Spotted) .....	12	
Wrasse and Parrot Fish .....	8	

*[Part 3 inserted in Gazette 29 Jan 2013 p. 315-17.]*

**Part 4 — Bag limits — freshwater finfish**

[r. 65E]

*[Heading inserted in Gazette 28 Jun 2013 p. 2893.]*

<b>Fish</b>	<b>Grouped bag limit of all species of freshwater finfish for one day</b>
Catfish .....	4
Grunter .....	
Trout, Brown and Rainbow .....	

*[Part 4 inserted in Gazette 28 Jun 2013 p. 2893.]*

**Part 5 — Bag limits — crustaceans**

[r. 65G]

*[Heading inserted in Gazette 29 Jan 2013 p. 317.]*

<b>Species</b>	<b>Bag limit for one day</b>
Cherabin .....	9 litres
Crab, Blue Swimmer .....	10 (in West Coast region) 20 (in other regions)
Crab, Mud, all species .....	5
Koonac.....	N/A
Marron .....	5 (in marron trophy water) 8 (in other waters)
Prawns, Western School and Western King .....	9 litres
Redclaw, Queensland .....	N/A
Rock Lobster, all species .....	8
Yabbies, Common and White.....	N/A
Other crustacean species not specified above.....	10

*[Part 5 inserted in Gazette 29 Jan 2013 p. 317; amended in Gazette 28 Jun 2013 p. 2893-4.]*

**Part 6 — Bag limits — molluscs and other invertebrates**

[r. 65H]

*[Heading inserted in Gazette 29 Jan 2013 p. 318.]*

<b>Species</b>	<b>Bag limit for one day</b>
Abalone, Greenlip and Brownlip .....	5
Abalone, Roe's .....	20 (including no more than 15 taken from Abalone Zone 1)
Ark Shell, Cockle, Pipsis and Clam, Venus.....	2 litres
Bloodworm .....	1 litre
Clam, Giant (other than <i>Tridacna gigas</i> ) .....	2
Mussel .....	9 litres (shell on)
Oyster .....	20
Razor shell .....	20
Scallop .....	20
Sea Urchin .....	20
Squid, Cuttlefish and Octopus .....	15
Zoila Cowry, Volute, Conch .....	10
Other molluscs and invertebrate species not specified .....	10

*[Part 6 inserted in Gazette 29 Jan 2013 p. 318; amended in Gazette 28 Jun 2013 p. 2894; 30 May 2014 p. 1723; 22 Oct 2014 p. 4088.]*

## **Schedule 4 — Categories of fish**

[s. 259 and r. 180]

*[Heading inserted in Gazette 29 Sep 2009 p. 3869.]*

### **Category 1 fish**

Abalone, Brownlip  
Abalone, Greenlip  
Abalone, Roe's  
Amberjack  
Barramundi  
Billfish (Marlins, Sailfish and Spearfish) and Swordfish  
Boarfish  
Cobia  
Cobbler (Estuary Catfish)  
Cod  
Cod, Potato  
Coral Trout  
Coral  
Crab, Blue Manna (Blue Swimmer)  
Crab, Champagne  
Crab, Crystal  
Crab, Giant  
Crab, Mud (Brown)  
Crab, Mud (Green)  
Dhufish, West Australian  
Dolphinfish (Mahi Mahi)  
Emperor and Seabream  
Foxfish, Western  
Groper, Baldchin  
Groper, Bass  
Groper, Blue  
Groper, Queensland  
Hapuku  
Kingfish, Yellowtail  
Leafy Seadragon  
Live Rock  
Mackerel, Broad-barred  
Mackerel, Narrow-barred Spanish  
Mackerel, Shark

Mackerel, Wahoo  
Marron  
Mulloway  
Mulloway, Northern  
Parrot Fish  
Pearl Perch  
Pigfish  
Rays  
Rock Lobster (all species)  
Sawfish  
Sea Perch, Tropical  
Shark, Great White  
Shark, Speartooth  
Shark, Whale  
Sharks  
Snapper, Pink  
Snapper, Queen (Blue Morwong)  
Snapper, Red  
Threadfin, Giant  
Trevalla  
Trevally, Giant  
Trevally, Golden  
Tripletail  
Tuna, Bigeye  
Tuna, Dogtooth  
Tuna, Longtail (Northern Bluefin)  
Tuna, Southern Bluefin  
Tuna, Yellowfin  
Tuskfish  
Weedy Seadragon  
Wrasse, Humphead Maori

**Category 2 fish**

Barracuda  
Bonito  
Bream, Black  
Bream, Northwest-Black  
Bream, Yellowfin  
Catfish  
Cherabin

Cuttlefish  
Dart  
Flathead  
Flounder  
Freshwater Crayfish (all species)  
Goatfish  
Grunter, Sooty  
Javelinfish and Sweetlips  
John Dory  
Leatherjacket  
Octopus  
Pike  
Prawn, Tiger  
Prawn, Western King  
Prawn, Western School  
Queenfish  
Razor shell  
Salmon, Australian  
Samson Fish  
Scallops  
Sea Cucumber (Beche-de-mer, Trepang)  
Sea Urchins  
Snook  
Sole  
Squid  
Sweep, Banded  
Sweep, Sea  
Tailor  
Tarwhine (Silver Bream)  
Threadfin, Blue  
Trevally, Silver (Skipjack)  
Trochus  
Trout, Brown  
Trout, Rainbow  
Tuna, Albacore  
Tuna, Skipjack  
Whiting, King George (Spotted)  
Whiting, Yellow-finned

**Category 3 fish**

Bait Fish  
Cockle, Ark Shell and other edible bivalves  
Clam, Venus  
Freshwater fish (other than freshwater fish listed as category 2 fish)  
Garfish  
Herring, Australian (Tommy Ruff)  
Longtom  
Mackerel, Blue (Common)  
Mullet  
Prawns (other than prawns listed as category 2 fish)  
Whiting (other than whiting listed as category 2 fish)  
Wrasse (other than wrasse listed as category 1 fish)

**Category 4 fish**

Any species of fish not specified in this Schedule to be category 1 fish, category 2 fish or category 3 fish.

*[Schedule 4 inserted in Gazette 29 Sep 2009 p. 3869-74; amended in Gazette 24 Aug 2011 p. 3409; 24 Feb 2012 p. 803; 30 May 2014 p. 1724.]*

## Schedule 5 — Noxious fish

[r. 70]

[Heading inserted in Gazette 22 Oct 2014 p. 4088.]

In this Schedule —

**Montebello Islands Marine Park** means all waters reserved under the *Conservation and Land Management Act 1984* section 13 as Class “A” Marine Reserve No. 9, Montebello Islands Marine Park;

**Port of Albany** means the area described to be the Port of Albany by order made by the Governor under the *Port Authorities Act 1999* section 24(1);

**Port of Bunbury** means the area described to be the Port of Bunbury by order made by the Governor under the *Port Authorities Act 1999* section 24(1);

**Port of Fremantle** means the area described to be the Port of Fremantle by order made by the Governor under the *Port Authorities Act 1999* section 24(1).

Scientific name	Examples of common names used	Area or areas where fish is prescribed to be noxious
<i>Acanthogobius flavimanus</i>	Yellow Fin Goby	Any area of the State
<i>Acartia (Acanthacartia) tonsa</i>	Calanoid Copepod	Any area of the State
<i>Acestrorhynchus microlepis</i>	Pike Characin	Any area of the State
<i>Acipenser baerii baerii</i>	Siberian Sturgeon	Any area of the State
<i>Acipenser baerii baicalensis</i>	Baikal Sturgeon	Any area of the State



Scientific name	Examples of common names used	Area or areas where fish is prescribed to be noxious
<i>Acipenser brevirostrum</i>	Shortnose Sturgeon	Any area of the State
<i>Acipenser dabryanus</i>	Yangtze Sturgeon	Any area of the State
<i>Acipenser fulvescens</i>	Lake Sturgeon	Any area of the State
<i>Acipenser gueldenstaedtii</i>	Russian Sturgeon	Any area of the State
<i>Acipenser medirostris</i>	Green Sturgeon	Any area of the State
<i>Acipenser mikadoi</i>	Sakhalin Sturgeon	Any area of the State
<i>Acipenser multiscutatus</i>	Japanese Sturgeon	Any area of the State
<i>Acipenser naccarii</i>	Adriatic Sturgeon	Any area of the State
<i>Acipenser nudiventris</i>	Fringebarbel Sturgeon	Any area of the State
<i>Acipenser oxyrinchus destotoi</i>	Gulf Sturgeon	Any area of the State
<i>Acipenser oxyrinchus oxyrinchus</i>	Atlantic Sturgeon	Any area of the State
<i>Acipenser persicus</i>	Persian Sturgeon	Any area of the State

<b>Scientific name</b>	<b>Examples of common names used</b>	<b>Area or areas where fish is prescribed to be noxious</b>
<i>Acipenser ruthenus</i>	Sterlet	Any area of the State
<i>Acipenser schrenckii</i>	Amur Sturgeon	Any area of the State
<i>Acipenser sinensis</i>	Chinese Sturgeon	Any area of the State
<i>Acipenser stellatus</i>	Starry Sturgeon	Any area of the State
<i>Acipenser sturio</i>	European Sturgeon	Any area of the State
<i>Acipenser transmontanus</i>	White Sturgeon	Any area of the State
<i>Alexandrium catenella</i>	Toxic Dinoflagellate	Any area of the State except in the Port of Fremantle
<i>Alexandrium minutum</i>	Toxic Dinoflagellate	Any area of the State
<i>Alexandrium monilatum</i>	Toxic Dinoflagellate	Any area of the State
<i>Alexandrium tamarense</i>	Toxic Dinoflagellate	Any area of the State
<i>Alfaro cultratus</i>	Knife-edged Livebearer	Any area of the State

Scientific name	Examples of common names used	Area or areas where fish is prescribed to be noxious
<i>Alfaro huberi</i>		Any area of the State
<i>Allomogurnda nesolepis</i>	Yellowbelly Gudgeon	Any area of the State
<i>Ameiurus brunneus</i>	Snail Bullhead	Any area of the State
<i>Ameiurus catus</i>	White Catfish	Any area of the State
<i>Ameiurus melas</i>	Black Bullhead	Any area of the State
<i>Ameiurus natalis</i>	Yellow Bullhead	Any area of the State
<i>Ameiurus nebulosus</i>	Brown Bullhead	Any area of the State
<i>Ameiurus platycephalus</i>	Flat Bullhead	Any area of the State
<i>Ameiurus serracanthus</i>	Spotted Bullhead	Any area of the State
<i>Amia calva</i>	Bowfin	Any area of the State
<i>Amphibalanus eburneus</i> (syn. <i>Balanus eburneus</i> )	Ivory Barnacle	Any area of the State

<b>Scientific name</b>	<b>Examples of common names used</b>	<b>Area or areas where fish is prescribed to be noxious</b>
<i>Amphibalanus improvisus</i> (syn. <i>Balanus improvisus</i> )	Bay Barnacle	Any area of the State
<i>Anabas cobojius</i>	Gangetic Climbing Perch	Any area of the State
<i>Anabas testudineus</i>	Climbing Perch	Any area of the State
<i>Anadara transversa</i> (syn. <i>A. demiri</i> )	Transverse Arc Clam	Any area of the State
<i>Anaspidoglanis macrostoma</i>	Flatnose Catfish	Any area of the State
<i>Apeltes quadracus</i>	Four-spined Stickleback	Any area of the State
<i>Arcuatula senhousia</i> (syn. <i>Musculista senhousia</i> )	Asian Bag Mussel, Asian Date Mussel	Any area of the State except in the Swan River and Port of Fremantle
<i>Aristichthys noblis</i>	Bighead Carp	Any area of the State
<i>Asterias amurensis</i>	Northern Pacific Seastar	Any area of the State
<i>Astyanax aeneus</i>	Banded Tetra	Any area of the State
<i>Astyanax fasciatus</i>	Banded Astyanax	Any area of the State

<b>Scientific name</b>	<b>Examples of common names used</b>	<b>Area or areas where fish is prescribed to be noxious</b>
<i>Bagrus ubangensis</i>	Ubangi Shovelnose Catfish	Any area of the State
<i>Balanus glandula</i>	Common Acorn Barnacle, White Buckshot Barnacle	Any area of the State
<i>Barbodes hexagonolepis</i>	Copper Mahseer	Any area of the State
<i>Belonesox belizanus</i>	Pike Minnow, Pike Killifish	Any area of the State
<i>Beroe ovata</i>		Any area of the State
<i>Blackfordia virginica</i>		Any area of the State
<i>Bonnemaisonia hamifera</i>	Bonnemaisonia's Hook Weed, Pink Cotton Wool	Any area of the State
<i>Boulengerochromis microlepis</i>	Giant Cichlid, Yellow-belly Cichlid	Any area of the State
<i>Brachidontes pharaonis</i>	Variable Mussel	Any area of the State
<i>Callinectes sapidus</i>	Chesapeake Blue Crab, Atlantic Blue Crab, Blue Crab	Any area of the State
<i>Carcinoscorpius rotundicauda</i>	Mangrove Horseshoe Crab	Any area of the State

<b>Scientific name</b>	<b>Examples of common names used</b>	<b>Area or areas where fish is prescribed to be noxious</b>
<i>Carcinus maenas</i>	European Green Crab, European Shore Crab	Any area of the State
<i>Catla catla</i>	Catla	Any area of the State
<i>Catlocarpio siamensis</i>	Giant Barb	Any area of the State
<i>Caulerpa taxifolia non-endemic spp.</i> (or variants)	Aquarium Weed, Feather Alga, Killer Alga	Any area of the State except in the Pilbara and Kimberley Region
<i>Centrarchidae</i> (entire family)	Banded Sunfish, Spotted Sunfish, Largemouth Bass, Bluegill	Any area of the State
<i>Centropomus</i> (entire genus)	Snooks (American)	Any area of the State
<i>Chaca bankanensis</i>	Angler Catfish	Any area of the State
<i>Chaca burmensis</i>	Burmensis Frogmouth Catfish	Any area of the State
<i>Chaca chaca</i>	Angler, Frogmouth and Squarehead Catfish	Any area of the State
<i>Chaetoceros concavicornis</i>	Centric Diatom	Any area of the State

Scientific name	Examples of common names used	Area or areas where fish is prescribed to be noxious
<i>Chaetoceros convolutus</i>	Centric Diatom	Any area of the State
<i>Channa spp.</i> (entire genus)	Snakehead	Any area of the State
<i>Charybdis</i> ( <i>Charybdis</i> ) <i>japonica</i>	Asian Paddle Crab	Any area of the State
<i>Chthamalus proteus</i>	Atlantic Barnacle, Caribbean Barnacle	Any area of the State
<i>Cirrhinus cirrhosus</i>	Mrigal	Any area of the State
<i>Clarias spp.</i> (entire genus)	Walking Catfish	Any area of the State
<i>Cliona thosina</i>	Boring Sponge, Sulfur Sponge	Any area of the State
<i>Codium fragile fragile</i> ( <i>syn. C. fragile tomentosoides</i> )	Dead Man's Fingers, Oyster Thief; Broccoli Weed	Any area of the State except in the Port of Albany
<i>Colossoma spp.</i> (entire genus)	Tambaqui Pacu, Pirapitinga	Any area of the State
<i>Corbicula fluminea</i>	Asian Clam, Asiatic Clam	Any area of the State
<i>Corbula gibba</i> ( <i>syn. Varicorbula gibba</i> )	Basket Shell, European Clam, Basket Shell Clam	Any area of the State

**Fish Resources Management Regulations 1995****Schedule 5** Noxious fish

---

<b>Scientific name</b>	<b>Examples of common names used</b>	<b>Area or areas where fish is prescribed to be noxious</b>
<i>Crassostrea ariakensis</i>	Suminoe Oyster, Asian Oyster	Any area of the State
<i>Crassostrea virginica</i>	American Oyster, Eastern Oyster	Any area of the State
<i>Crenicichla lepidota</i>	Pike Cichlid	Any area of the State
<i>Crepidula fornicata</i>	Slipper Limpet, Atlantic Slipper Snail	Any area of the State
<i>Ctenopharyngodon idella</i>	Grass Carp	Any area of the State
<i>Ctenopoma argentoventer</i>	Silverbelly Ctenopoma	Any area of the State
<i>Ctenopoma kingsleyae</i>	Tailspot Ctenopoma	Any area of the State
<i>Ctenopoma multispine</i>	Manyspined Ctenopoma	Any area of the State
<i>Ctenopoma muriei</i>	Ocellated Labyrinth Fish	Any area of the State
<i>Ctenopoma nigropannosum</i>	Twospot Climbing Perch	Any area of the State
<i>Ctenopoma ocellatum</i>	Eyespot Ctenopoma	Any area of the State
<i>Ctenopoma weeksii</i>	Mottled Ctenopoma	Any area of the State



Scientific name	Examples of common names used	Area or areas where fish is prescribed to be noxious
<i>Culaea inconstans</i>	Brook Stickleback	Any area of the State
<i>Didemnum non-endemic spp.</i>	Colonial Sea Squirt, Colonial Ascidian	Any area of the State
<i>Didemnum perlucidum</i>	White Sea Squirt, White Ascidian	Montebello Islands Marine Park
<i>Didemnum vexillum</i>	Colonial Sea Squirt	Any area of the State
<i>Dikerogammarus villosus</i>	Killer Shrimp	Any area of the State
<i>Dinophysis norvegica</i>	Toxic Dinoflagellate	Any area of the State
<i>Dormitator latifrons</i>	Pacific Fat Sleeper	Any area of the State
<i>Dormitator lebretonis</i>		Any area of the State
<i>Dormitator maculatus</i>	Fat Sleeper	Any area of the State
<i>Dreissena bugensis</i>	Quagga Mussel	Any area of the State
<i>Dreissena polymorpha</i>	European Zebra Mussel, Wandering Mussel	Any area of the State

<b>Scientific name</b>	<b>Examples of common names used</b>	<b>Area or areas where fish is prescribed to be noxious</b>
<i>Elassoma spp.</i> (entire genus)	Pygmy Sunfish	Any area of the State
<i>Electrophorus electricus</i>	Electric Eel	Any area of the State
<i>Eleotris amblyopsis</i>	Large Scaled Spiny Cheek Sleeper	Any area of the State
<i>Eleotris sandwicensis</i>	Sandwich Island Sleeper	Any area of the State
<i>Ensis directus</i>	Jack-knife Clam	Any area of the State
<i>Eriocheir sinensis</i>	Chinese Mitten Crab	Any area of the State
<i>Eriocheir spp.</i>	Mitten Crabs	Any area of the State
<i>Erpetoichthys calabaricus</i>	Reedfish	Any area of the State
<i>Erythrinus spp.</i> (entire genus)	Trahiras (Various)	Any area of the State
<i>Esox spp.</i> (entire genus)	Pikes (Freshwater)	Any area of the State
<i>Fucus evanescens</i>	Brown Macroalga, Wrack	Any area of the State
<i>Gambusia spp.</i> (entire genus)	Mosquito Fish	Any area of the State

Scientific name	Examples of common names used	Area or areas where fish is prescribed to be noxious
<i>Gelliodes fibrosa</i>	Gray Encrusting Sponge	Any area of the State
<i>Geukensia demissa</i>	Ribbed Mussel	Any area of the State
<i>Gobiomorphus gobioides</i>	Giant Bully	Any area of the State
<i>Gobiomorphus huttoni</i>	Redfin Bully	Any area of the State
<i>Gobiomorus dormitor</i>	Bigmouth Sleeper	Any area of the State
<i>Gobiomorus maculatus</i>	Pacific Sleeper	Any area of the State
<i>Grateloupia turuturu</i>	Devil's Tongue Weed, Asian Red Seaweed	Any area of the State
<i>Gymnarchus niloticus</i>	Aba Aba	Any area of the State
<i>Gymnodinium catenatum</i>		Any area of the State
<i>Helicophagus leptorhynchus</i>		Any area of the State
<i>Helicophagus waandersii</i>		Any area of the State
<i>Hemichromis fasciatus</i>	Banded Jewelfish	Any area of the State

<b>Scientific name</b>	<b>Examples of common names used</b>	<b>Area or areas where fish is prescribed to be noxious</b>
<i>Hemigrapsus penicillatus</i> [syn. <i>Grapsus (Eriocheir) penicillatus</i> ]	Hairy-clawed Shore Crab	Any area of the State
<i>Hemigrapsus sanguineus</i>	Asian Shore Crab, Japanese Shore Crab	Any area of the State
<i>Hemigrapsus takanoi</i>	Brush-clawed Shore Crab	Any area of the State
<i>Hepsetus odoe</i>	African Pike	Any area of the State
<i>Heterandria bimaculata</i>	Twospot Livebearer	Any area of the State
<i>Heteropneustes fossilis</i>	Stinging Catfish	Any area of the State
<i>Himantura kittipongi</i>		Any area of the State
<i>Himantura krempfi</i>	Marbled Freshwater Whip Ray	Any area of the State
<i>Himantura oxyrhyncha</i>	Marbled Whipray	Any area of the State
<i>Hoplerythrinus spp.</i> (entire genus)	Trahiras (Various)	Any area of the State
<i>Hoplias spp.</i> (entire genus)	Trahiras (Various)	Any area of the State

<b>Scientific name</b>	<b>Examples of common names used</b>	<b>Area or areas where fish is prescribed to be noxious</b>
<i>Huso huso</i>	Beluga	Any area of the State
<i>Hydrocynus spp.</i> (entire genus)	Tigerfish	Any area of the State
<i>Hydroides dianthus</i>	Serpulid Tube Worm, Limy Tube Worm	Any area of the State
<i>Hypophthalmichthys molitrix</i>	Silver Carp	Any area of the State
<i>Hypseleotris cyprinoides</i>	Tropical Carp-gudgeon	Any area of the State
<i>Hypseleotris tohizonae</i>		Any area of the State
<i>Ichthyborinae</i> (entire subfamily)	African Pike-characin, Tubenose Poacher, Fin Eater	Any area of the State
<i>Ictalurus balsanus</i>	Balsas Catfish	Any area of the State
<i>Ictalurus dugesii</i>	Lerma Catfish	Any area of the State
<i>Ictalurus furcatus</i>	Blue Catfish	Any area of the State
<i>Ictalurus lupus</i>	Headwater Catfish	Any area of the State

**Fish Resources Management Regulations 1995****Schedule 5** Noxious fish

---

<b>Scientific name</b>	<b>Examples of common names used</b>	<b>Area or areas where fish is prescribed to be noxious</b>
<i>Ictalurus mexicanus</i>	Rio Verde Catfish	Any area of the State
<i>Ictalurus ochoterenai</i>	Chapala Catfish	Any area of the State
<i>Ictalurus pricei</i>	Yaqui Catfish	Any area of the State
<i>Ictalurus punctatus</i>	Channel Catfish	Any area of the State
<i>Labeo calbasu</i>	Orange Fin Labeo	Any area of the State
<i>Labeo rohita</i>	Rohu	Any area of the State
<i>Lates microlepis</i>	Forktail Lates	Any area of the State
<i>Lates niloticus</i>	Nile Perch	Any area of the State
<i>Lebiasina bimaculata</i>	Twospot Lebiasina	Any area of the State
<i>Lepidosiren paradoxa</i>	South American Lungfish	Any area of the State
<i>Leptolebias aureoguttatus</i>		Any area of the State
<i>Leptolebias marmoratus</i>	Marbled Pearlfish	Any area of the State

Scientific name	Examples of common names used	Area or areas where fish is prescribed to be noxious
<i>Leptolebias minimus</i>	Barred Tail Pearlfish	Any area of the State
<i>Leptolebias opalescens</i>	Opal Pearlfish	Any area of the State
<i>Limnoperna fortunei</i>	Golden Mussel	Any area of the State
<i>Malapterurus spp.</i> (entire genus)	Electric Catfish	Any area of the State
<i>Maoricolpus roseus</i>	New Zealand Screwshell	Any area of the State
<i>Marenzelleria non-endemic spp.</i>	Red-Gilled Mudworm	Any area of the State
<i>Melanotheron melanotheron</i>	Blackchin Tilapia	Any area of the State
<i>Misgurnus anguillicaudatus</i>	Weatherloach	Any area of the State
<i>Mnemiopsis leidyi</i>	Comb Jelly	Any area of the State
<i>Monia nobilis</i> (syn. <i>Anomia nobilis</i> )	Jingle Shell, Saddle Oyster	Any area of the State
<i>Mormyrops anguilloides</i>	Cornish Jack, Bottlenose	Any area of the State

<b>Scientific name</b>	<b>Examples of common names used</b>	<b>Area or areas where fish is prescribed to be noxious</b>
<i>Mya arenaria</i>	Soft-shell Clam, Long-neck Clam, Steamer	Any area of the State
<i>Mytella charruana</i>	Charru Mussel	Any area of the State
<i>Mytilopsis leucophaeata</i>	Dark False Mussel, Conrad's False Mussel	Any area of the State
<i>Mytilopsis sallei</i>	Black-Striped Mussel	Any area of the State
<i>Mytilopsis spp.</i> (entire genus) and <i>Congerina spp.</i> (entire genus)	Black-Striped Mussel	Any area of the State
<i>Neogobius melanostomus</i>	Round Goby	Any area of the State
<i>Notropis spp.</i> (entire genus)	Shiners	Any area of the State
<i>Noturus albater</i>	Ozark Madtom	Any area of the State
<i>Noturus baileyi</i>	Smoky Madtom	Any area of the State
<i>Noturus crypticus</i>	Chucky Madtom	Any area of the State
<i>Noturus elegans</i>	Elegant Madtom	Any area of the State



<b>Scientific name</b>	<b>Examples of common names used</b>	<b>Area or areas where fish is prescribed to be noxious</b>
<i>Noturus eleutherus</i>	Mountain Madtom	Any area of the State
<i>Noturus exilis</i>	Slender Madtom	Any area of the State
<i>Noturus fasciatus</i>	Saddled Madtom	Any area of the State
<i>Noturus flavater</i>	Checkered Madtom	Any area of the State
<i>Noturus flavipinnis</i>	Yellowfin Madtom	Any area of the State
<i>Noturus flavus</i>	Stonecat	Any area of the State
<i>Noturus funebris</i>	Black Madtom	Any area of the State
<i>Noturus furiosus</i>	Carolina Madtom	Any area of the State
<i>Noturus gilberti</i>	Orangefin Madtom	Any area of the State
<i>Noturus gladiator</i>		Any area of the State
<i>Noturus gyrinus</i>	Tadpole Madtom	Any area of the State
<i>Noturus hildebrandi hildebrandi</i>	Least Madtom	Any area of the State

<b>Scientific name</b>	<b>Examples of common names used</b>	<b>Area or areas where fish is prescribed to be noxious</b>
<i>Noturus hildebrandi lautus</i>		Any area of the State
<i>Noturus insignis</i>	Margined Madtom	Any area of the State
<i>Noturus lachneri</i>	Ouachita Madtom	Any area of the State
<i>Noturus leptacanthus</i>	Speckled Madtom	Any area of the State
<i>Noturus maydeni</i>	Black River Madtom	Any area of the State
<i>Noturus miurus</i>	Brindled Madtom	Any area of the State
<i>Noturus munitus</i>	Frecklebelly Madtom	Any area of the State
<i>Noturus nocturnus</i>	Freckled Madtom	Any area of the State
<i>Noturus phaeus</i>	Brown Madtom	Any area of the State
<i>Noturus placidus</i>	Neosho Madtom	Any area of the State
<i>Noturus stanauli</i>	Pygmy Madtom	Any area of the State
<i>Noturus stigmosus</i>	Northern Madtom	Any area of the State

Scientific name	Examples of common names used	Area or areas where fish is prescribed to be noxious
<i>Noturus taylori</i>	Caddo Madtom	Any area of the State
<i>Noturus trautmani</i>	Scioto Madtom	Any area of the State
<i>Oreochromis spp.</i> (entire genus)	Tilapia (Various)	Any area of the State
<i>Oxydoras spp.</i> (entire genus)	Ripsaw Catfish, Black Doras, Black Shielded Catfish	Any area of the State
<i>Oxyeleotris heterodon</i>	Sentani Gudgeon	Any area of the State
<i>Oxyeleotris marmorata</i>	Marble Goby	Any area of the State
<i>Oxyeleotris siamensis</i>		Any area of the State
<i>Oxyeleotris urophthalmoides</i>		Any area of the State
<i>Oxyeleotris urophthalmus</i>		Any area of the State
<i>Pachygrapsus fakaravensis</i>	Polynesian Grapsid Crab	Any area of the State
<i>Pangasianodon gigas</i>	Mekong Giant Catfish	Any area of the State

<b>Scientific name</b>	<b>Examples of common names used</b>	<b>Area or areas where fish is prescribed to be noxious</b>
<i>Pangasius conchophilus</i>		Any area of the State
<i>Pangasius elongatus</i>		Any area of the State
<i>Pangasius krempfi</i>		Any area of the State
<i>Pangasius kunyit</i>		Any area of the State
<i>Pangasius larnaudii</i>	Spot Pangasius	Any area of the State
<i>Pangasius macronema</i>		Any area of the State
<i>Pangasius nasutus</i>		Any area of the State
<i>Pangasius nieuwenhuisii</i>		Any area of the State
<i>Pangasius pangasius</i>	Yellowtailed Catfish	Any area of the State
<i>Paratrygon aiereba</i>	Discus Ray	Any area of the State
<i>Paravandelia oxyptera</i>	Parasitic Catfish	Any area of the State

Scientific name	Examples of common names used	Area or areas where fish is prescribed to be noxious
<i>Perna canaliculus</i>	New Zealand Mussel, New Zealand Green-lipped Mussel, Greenshell Mussel, Kuku, Kutai	Any area of the State
<i>Perna perna</i>	Brown Mussel	Any area of the State
<i>Perna viridis</i>	Asian Green Mussel	Any area of the State
<i>Pfiesteria piscicida</i>	Toxic Dinoflagellate	Any area of the State
<i>Phoxinus erythrogaster</i>	Southern Redbelly Dace	Any area of the State
<i>Polyodon spathula</i>	Mississippi Paddlefish	Any area of the State
<i>Potamocorbula amurensis</i> (syn. <i>Corbula amurensis</i> )	Asian Clam, Amur River Clam, Overbite Clam, Brackish-water Corbula	Any area of the State
<i>Procambarus clarkii</i>	Red Swamp Crayfish	Any area of the State
<i>Protopterus aethiopicus</i>	Marbled Lungfish	Any area of the State
<i>Protopterus amphibius</i>	Gilled Lungfish	Any area of the State

**Fish Resources Management Regulations 1995****Schedule 5** Noxious fish

---

<b>Scientific name</b>	<b>Examples of common names used</b>	<b>Area or areas where fish is prescribed to be noxious</b>
<i>Protopterus annectens</i>	African Lungfish	Any area of the State
<i>Protopterus dolloi</i>	Slender Lungfish	Any area of the State
<i>Psephurus gladius</i>	Chinese Swordfish	Any area of the State
<i>Pseudodiaptomus marinus</i>	Calanoid Copepod	Any area of the State
<i>Pseudo-nitzschia seriata</i>	Pennate Diatom	Any area of the State
<i>Pseudoplatystoma fasciatum</i>	Tiger Catfish	Any area of the State
<i>Pungitius pungitius</i>	Ninespine Stickleback	Any area of the State
<i>Pygocentrus spp.</i> (entire genus)	Piranha (Various)	Any area of the State
<i>Pylodictis olivaris</i>	Flathead Catfish	Any area of the State
<i>Rapana venosa</i> (syn. <i>R. thomasi</i> )	Asian Rapa Whelk, Veined Rapa Whelk	Any area of the State
<i>Rhithropanopeus harrisi</i>	Harris Mud Crab, White-fingered Mud Crab, Zuiderzee Crab	Any area of the State

Scientific name	Examples of common names used	Area or areas where fish is prescribed to be noxious
<i>Rutilus rutilus</i>	Roach	Any area of the State
<i>Sabella spallanzanii</i>	European Fan Worm	Any area of the State except in the West Coast Region and the South Coast Region
<i>Sargassum muticum</i>	Japweed, Wireweed, Strangle Weed	Any area of the State
<i>Sargochromis spp.</i> (entire genus)	Pink, Slender, Greenwood's, Mortimer's, Cunene and Green Happy	Any area of the State
<i>Sarotherodon spp.</i> (entire genus)	Tilapia (Various)	Any area of the State
<i>Schilbe intermedius</i>	Silver Catfish	Any area of the State
<i>Schilbe marmoratus</i>	Shoulderspot Catfish	Any area of the State
<i>Schilbe mystus</i>	African Butter Catfish	Any area of the State
<i>Serranochromis spp.</i> (entire genus)	Cichlids	Any area of the State
<i>Serrasalmus spp.</i> (entire genus)	Piranha (Various)	Any area of the State

<b>Scientific name</b>	<b>Examples of common names used</b>	<b>Area or areas where fish is prescribed to be noxious</b>
<i>Siganus luridus</i>	Dusky Spinefoot	Any area of the State
<i>Siganus rivulatus</i>	Marbled Spinefoot, Rabbit Fish	Any area of the State
<i>Silurus spp.</i> (entire genus)	European Catfish, Wels Catfish	Any area of the State
<i>Solidobalanus fallax</i>	Warm-water Barnacle	Any area of the State
<i>Tilapia spp.</i> (all except <i>T. buttikoferi</i> )	Tilapia (Various)	Any area of the State
<i>Tinca tinca</i>	Tench	Any area of the State
<i>Tomeurus gracilis</i>		Any area of the State
<i>Tor</i> (entire genus)	River Carp, Deccan, High Backed, Jungha, Putitor, Thai Mahseer	Any area of the State
<i>Tortanus</i> ( <i>Eutortanus</i> ) <i>dextrilobatus</i>		Any area of the State
<i>Tridentiger barbatus</i>	Shokihaze Goby	Any area of the State
<i>Tridentiger bifasciatus</i>	Shimofuri Goby	Any area of the State



<b>Scientific name</b>	<b>Examples of common names used</b>	<b>Area or areas where fish is prescribed to be noxious</b>
<i>Tridentiger trigonocephalus</i>	Chameleon Goby, Striped Goby	Any area of the State except the Port of Bunbury, the Port of Fremantle and the Swan River
<i>Undaria pinnatifida</i>	Japanese Kelp, Wakame	Any area of the State
<i>Valencia hispanica</i>	Valencia Toothcarp	Any area of the State
<i>Womersleyella setacea</i> ( <i>syn. Polysiphonia setacea</i> )	Red Polysiphonous Macroalga	Any area of the State
<i>Zacco platypus</i>	Freshwater Minnow	Any area of the State

[Schedule 5 inserted in Gazette 22 Oct 2014 p. 4088-115.]

## **Schedule 6**

### **Area of land prescribed under section 91(d) of the Act**

[reg. 68]

All areas of Western Australia north and east of:

- Perth city generally south east along Albany Highway to the intersection of Albany Highway and Bannister/Marradong Road
- Thence generally south west along that road to Boddington (town)
- Thence generally south west along that road to Marradong (location)
- Thence generally south west along Pinjarra/Williams Road to Quindanning (town)
- Thence southerly along Quindanning/Darkan Road to Darkan (town)
- Thence southerly along Darkan Road south to Duranillan (town)
- Thence west along Bowelling/Duranillan Road to Capercup Road
- Thence south along Capercup Road south to Boyup Brook/Arthur Road
- Thence south west along that road to Glenorchy Road
- Thence south east along that road to Qualeup North/South Road
- Thence south along that road to Kojonup/Donnybrook Road
- Thence south west along that road to Foley Road
- Thence south west along that road to Woodenbillup Road
- Thence south west along that road to Mullidup Road
- Thence south east along that road to Wandoora Road
- Thence south and south east along that road to Kojonup/Frankland Road
- Thence south along that road to Frankland (town)
- Thence south along Frankland/Rocky Gully Road to Rocky Gully (town) to its intersection with Muirs Highway
- Thence generally east along Muirs Highway to Mount Barker (town)
- Thence generally east along that highway to Albany townsite.

## Schedule 7

[reg. 3(2)]

### List of common and scientific names

#### Division 1 — Marine or fluvio-marine fish

*[Heading inserted in Gazette 13 Nov 2007 p. 5692.]*

<b>Common name</b>	<b>Scientific name</b>
Amberjack .....	<i>Seriola dumerlii</i>
Anchovy, Australian .....	<i>Engraulis australis</i>
Bait Fish .....	<u>Families</u> Clupeidae and Engraulidae
Barracuda .....	<i>Sphyraena barracuda</i>
Barracouta (Gemfish) .....	<u>Family</u> Gempylidae
Barramundi (Giant Perch) .....	<i>Lates calcarifer</i>
Billfish (Marlins, Sailfish, Spearfish)	<u>Family</u> Istiophoridae
Boarfish .....	<u>Family</u> Pentacerotidae
Bonefish .....	<i>Albula</i> spp.
Bonito, Leaping .....	<i>Cybiosarda elegans</i>
Bonito, Oriental .....	<i>Sarda orientalis</i>
Bream, Black .....	<i>Acanthopagrus butcheri</i>
Bream, Fingermark .....	<i>Lutjanus johnii</i>
Bream, Northwest-Black .....	<i>Acanthopagrus palmaris</i>
Bream, Yellowfin .....	<i>Acanthopagrus latus</i>
Catfish .....	<u>Families</u> Ariidae and Plotosidae
Cobbler (Estuary Catfish) .....	<i>Cnidoglanis macrocephalus</i>
Cobia .....	<i>Rachycentron canadus</i>
Cod .....	<u>Family</u> Serranidae
Cod, Barramundi .....	<i>Cromileptes altivelis</i>
Cod, Breaksea .....	<i>Epinephelus armatus</i>
Cod, Chinaman (Charlie Court) .....	<i>Epinephelus rivulatus</i>
Cod, Estuary .....	<i>Epinephelus coioides</i>
Cod, Grey Banded Rock .....	<i>Hyporthodus octofasciatus</i>
Cod, Malabar .....	<i>Epinephelus Malabaricus</i>
Cod, Murray .....	<i>Maccullochela peeli</i>
Cod, Potato .....	<i>Epinephelus tukula</i>

**Fish Resources Management Regulations 1995****Schedule 7** List of common and scientific names**Division 1** Marine or fluvio-marine fish

<b>Common name</b>	<b>Scientific name</b>
Cod, Rankin .....	<i>Epinephelus multinotatus</i>
Coral Trout .....	<i>Plectropomus</i> spp.
Coronation Trout .....	<i>Variola louti</i>
Dart .....	<i>Trachinotus</i> spp.
Dhufish, West Australian .....	<i>Glaucosoma hebraicum</i>
Dolphinfish (Mahi Mahi) .....	<i>Coryphaena hippurus</i>
Dory, John .....	<i>Zenopsis nebulosus</i>
Dory, Mirror .....	<i>Zeus faber</i>
Emperor and Seabream .....	<u>Family</u> Lethrinidae
Emperor, Blue-lined .....	<i>Lethrinus laticaudis</i>
Emperor, Red (Government Bream)	<i>Lutjanus sebae</i>
Emperor, Spangled .....	<i>Lethrinus nebulosus</i>
Flathead .....	<i>Platycephalus</i> spp.
Flathead, Bar-tailed .....	<i>Platycephalus endrachtensis</i>
Flathead, Blue-spotted (Sand) .....	<i>Platycephalus speculator</i>
Flathead, Long-spined (Sand) .....	<i>Platycephalus longispinus</i>
Flathead, Marbled .....	<i>Platycephalus marmoratus</i>
Flounder .....	<i>Pseudorhombus</i> spp.
Foxfish, Western and Pigfish .....	<i>Bodianus</i> spp.
Garfish .....	<u>Family</u> Hemirhamphidae
Goatfish .....	<u>Family</u> Mullidae
Groper .....	<u>Family</u> Labridae
Groper, Baldchin .....	<i>Choerodon rubescens</i>
Groper, Bass .....	<i>Polyprion americanus</i>
Groper, Queensland .....	<i>Epinephelus lanceolatus</i>
Groper, Western Blue .....	<i>Achoerodus gouldii</i>
Hapuku .....	<i>Polyprion oxygeneios</i>
Hardyhead .....	<u>Family</u> Atherinidae
Herring, Australian (Tommy Ruff) ..	<i>Arripis georgianus</i>
Herring, Giant .....	<i>Elops hawaiiensis</i>
Herring, Perth .....	<i>Nematalosa vlaminghi</i>
Javelinfish and Sweetlips .....	<u>Family</u> Haemuidae
Kingfish, Yellowtail .....	<i>Seriola lalandi</i>
Leatherjacket .....	<u>Family</u> Monacanthidae
Longtom .....	<u>Family</u> Belonidae

<b>Common name</b>	<b>Scientific name</b>
Mackerel .....	<i>Scomberomorus</i> spp.
Mackerel, Australian Spotted .....	<i>Scomberomorus munroi</i>
Mackerel, Blue (Common) .....	<i>Scomber australasicus</i>
Mackerel, Broad-barred Spanish .....	<i>Scomberomorus semifasciatus</i>
Mackerel, Jack .....	<i>Trachurus declivis</i>
Mackerel, Narrow-barred Spanish ....	<i>Scomberomorus commerson</i>
Mackerel, Peruvian Jack .....	<i>Trachurus murphi</i>
Mackerel, Queensland School .....	<i>Scomberomorus queenslandicus</i>
Mackerel, Scaly .....	<i>Sardinella lemuru</i>
Mackerel, Shark .....	<i>Grammatorcynus bicarinatus</i>
Mackerel, Wahoo .....	<i>Acanthocybium solandri</i>
Mackerel, Yellowtail Jack .....	<i>Trachurus novaezelandiae</i>
Mangrove Jack .....	<i>Lutjanus argentimaculatus</i>
Maray .....	<i>Etrumeus teres</i>
Milkfish .....	<i>Chanos chanos</i>
Mullet .....	<u>Family</u> Mugilidae
Mullet, Sea .....	<i>Mugil cephalus</i>
Mullet, Yellow-eye .....	<i>Aldrichetta forsteri</i>
Mulloway (River Kingfish) .....	<i>Argyrosomus hololepidotus</i>
Mulloway, Northern .....	<i>Protonibea diacanthus</i>
Nannygai .....	<i>Centroberyx</i> spp.
Parrot Fish .....	<u>Family</u> Scaridae
Pearl Perch .....	<i>Glaucosoma</i> spp., excluding <i>G. hebraicum</i>
Pike, Long-finned .....	<i>Dinolestes lewini</i>
Pike, Striped Sea .....	<i>Sphyræna obtusata</i>
Pilchard (Mulie) .....	<i>Sardinops neopilchardus</i>
Queenfish .....	<i>Scomberoides commersonianus</i>
Queenfish, Needleskin.....	<i>Scomberoides tol</i>
Ray, Eagle .....	<u>Family</u> Myliobatididae
Ray, Manta .....	<i>Manta birostris</i>
Rays .....	<u>Superorder</u> Batoidea
Redbait .....	<i>Emmelichthys nitidus</i>
Salmon, Atlantic .....	<i>Salmo salar</i>
Salmon, Australian .....	<i>Arripis truttaceus</i>

**Fish Resources Management Regulations 1995**

**Schedule 7** List of common and scientific names

**Division 1** Marine or fluvio-marine fish

---

<b>Common name</b>	<b>Scientific name</b>
Samson Fish (Sea Kingfish) .....	<i>Seriola hippos</i>
Scad, Yellowtail .....	<i>Trachurus novaezelandiae</i>
Seadragon, Leafy .....	<i>Phycodurus eques</i>
Seadragon, Weedy .....	<i>Phyllopteryx taeniolatus</i>
Sea Perch, Crimson .....	<i>Lutjanus erythropterus</i>
Sea Perch, Scarlett .....	<i>Lutjanus malabaricus</i>
Sea Perch, Stripey .....	<i>Lutjanus carponotatus</i>
Sea Perch, Tropical .....	<u>Family</u> Lutjanidae
Shark, Dusky .....	<i>Carcharhinus obscurus</i>
Shark, Great White .....	<i>Carcharodon carcharias</i>
Shark, Speartooth .....	<i>Glyphis</i> spp.
Shark, Whale .....	<i>Rhiodon typus</i>
Shark, Whaler .....	<u>Family</u> Carcharhinidae
Sharks .....	<u>Orders</u> Squatiniformes, Pristiophoriformes, Squaliformes, Hexanchiformes, Carcharhiniformes, Lamniformes, Orectolobiformes and Heterodontiformes
Snapper, Deep water.....	<i>Pristipomoides</i> spp. and <i>Etelis</i> spp.
Snapper, Goldband .....	<i>Pristipomoides multidens</i>
Snapper, Northwest .....	<i>Lethrinus</i> spp. excluding <i>L. nebulosus</i> and <i>L. laticaudis</i>
Snapper, Pink .....	<i>Pagrus auratus</i>
Snapper, Queen (Blue Morwong) ....	<i>Nemadactylus valenciennesi</i>
Snapper, Red (Redfish) .....	<i>Centroberyx</i> spp.
Snook .....	<i>Sphyraena novaehollandiae</i>
Sole .....	<u>Families</u> Soleidae and Cynoglossidae
Sprat, Blue .....	<i>Spratelloides robustus</i>
Sprat, Sandy (Whitebait) .....	<i>Hyperlophus vittatus</i>
Swallowtail .....	<i>Centroberyx lineatus</i>
Sweep, Banded .....	<i>Scorpius georgianus</i>
Sweep, Sea .....	<i>Scorpius aequipinnis</i>
Swordfish .....	<u>Family</u> Xiphiidae
Tailor .....	<i>Pomatomus saltatrix</i>
Tarwhine (Silver Bream) .....	<i>Rhabdosargus sarba</i>
Threadfin .....	<i>Polydactylus</i> spp.

Common name	Scientific name
Threadfin, Blue .....	<i>Eleutheronema tetradactylum</i>
Threadfin, Giant .....	<i>Polydactylus macrochir</i>
Trevalla .....	<u>Family</u> Centrolophidae
Trevally .....	<u>Family</u> Carangidae
Trevally, Diamond .....	<i>Alectis indicus</i>
Trevally, Giant .....	<i>Caranx ignobilis</i>
Trevally, Golden .....	<i>Gnathanodon speciosus</i>
Trevally, Silver (Skipjack) .....	<i>Pseudocaranx</i> spp.
Tripletail .....	<i>Lobotes surinamensis</i>
Tuna, Albacore .....	<i>Thunnus alalunga</i>
Tuna, Bigeye .....	<i>Thunnus obesus</i>
Tuna, Dogtooth .....	<i>Gymnosarda unicolour</i>
Tuna, Longtail (Northern Bluefin) ....	<i>Thunnus tonggol</i>
Tuna, Mackerel.....	<i>Euthynnus affinus</i>
Tuna, Skipjack .....	<i>Katsuwonus pelamis</i>
Tuna, Southern Bluefin .....	<i>Thunnus maccoyii</i>
Tuna, Yellowfin .....	<i>Thunnus albacares</i>
Tuskfish .....	<i>Choerodon</i> spp. excluding <i>C.rubescens</i>
Tuskfish, Blackspot .....	<i>Choerodon schoenleinii</i>
Tuskfish, Blue .....	<i>Choerodon cyanodus</i>
Whiting .....	<i>Sillago</i> spp.
Whiting, Golden-lined (Rough Scale)	<i>Sillago analis</i>
Whiting, King George (Spotted) .....	<i>Sillaginodes punctata</i>
Whiting, Southern School (Silver) ...	<i>Sillago bassensis</i>
Whiting, Yellow-finned .....	<i>Sillago schomburgkii</i>
Wrasse .....	<u>Family</u> Labridae
Wrasse, Humphead Maori .....	<i>Cheilinus undulatus</i>

*[Division 1 amended in Gazette 30 Aug 1996 p. 4320-1; 12 Sep 1997 p. 5154; 19 Jun 1998 p. 3264; 1 Oct 2003 p. 4341-3; 4 Nov 2005 p. 5317; 22 Dec 2005 p. 6238-9; 10 Nov 2006 p. 4710; 13 Nov 2007 p. 5693; 13 Feb 2009 p. 299; 29 Sep 2009 p. 3874-5; 8 Dec 2009 p. 4997; 29 Mar 2011 p. 1153; 24 Aug 2011 p. 3409; 29 Jan 2013 p. 318; 30 May 2014 p. 1724.]*

**Fish Resources Management Regulations 1995**

**Schedule 7** List of common and scientific names

**Division 2** Freshwater fish

---

**Division 2 — Freshwater fish**

[Heading inserted in Gazette 13 Nov 2007 p. 5692.]

---

<b>Common name</b>	<b>Scientific name</b>
Carp, European (Common) .....	<i>Cyprinus carpio</i>
Cobbler, Freshwater .....	<i>Tandanus bostocki</i>
Cod, Murray .....	<i>Maccullochella peeli</i>
Eel, Short-finned .....	<i>Anguilla australis</i>
Goldfish .....	<i>Carassius auratus</i>
Grunter .....	<u>Family</u> Terapontidae
Grunter, Sooty .....	<i>Hephaestus fuliginasus</i>
Perch, Golden .....	<i>Macquaria ambigua</i>
Perch, Redfin (English or European)	<i>Perca fluviatilis</i>
Perch, Silver .....	<i>Bidyanus bidyanus</i>
Sawfish .....	<u>Family</u> Pristidae
Trout, Brown .....	<i>Salmo trutta</i>
Trout, Rainbow .....	<i>Oncorhynchus mykiss</i>

---

[Division 2 amended in Gazette 22 Dec 2005 p. 6239; 13 Nov 2007 p. 5693; 23 Jul 2010 p. 3406; 29 Jan 2013 p. 318.]



**Division 3 — Crustaceans**

[Heading inserted in Gazette 13 Nov 2007 p. 5692.]

Common name	Scientific name
Cherabin .....	<i>Macrobrachium</i> spp.
Crab .....	<i>Chaceon</i> , <i>Hypothalassia</i> , <i>Ovalipes</i> , <i>Portunus</i> , <i>Pseudocarcinus</i> and <i>Scylla</i> spp.
Crab, Blue Manna (Blue Swimmer) .	<i>Portunus pelagicus</i>
Crab, Champagne .....	<i>Hypothalassia acerba</i>
Crab, Crystal .....	<i>Chaceon</i> spp.
Crab, Giant .....	<i>Pseudocarcinus gigas</i>
Crab, Mud (Brown) .....	<i>Scylla olivacea</i>
Crab, Mud (Green) .....	<i>Scylla serrata</i>
Crab, White Spotted Sand .....	<i>Ovalipes australiensis</i>
Freshwater Crayfish .....	<i>Cherax</i> spp. excluding <i>C. tenuimanus</i> and <i>C. cainii</i>
Gilgie .....	<i>Cherax quinquecarinatus</i> and <i>crassimanus</i>
Koonac .....	<i>Cherax plebejus</i> and <i>glaber</i>
Marron .....	<i>Cherax tenuimanus</i> and <i>C. cainii</i>
Marron, Blue .....	<i>Cherax tenuimanus</i> var. <i>caerulens</i>
Prawn .....	<u>Family</u> Penaeidae
Prawn, Banana .....	<i>Penaeus merguensis</i>
Prawn, Brown Tiger .....	<i>Penaeus esculentus</i>
Prawn, Western King .....	<i>Penaeus latisulcatus</i>
Prawn, Western School .....	<i>Metapenaeus dalli</i>
Redclaw, Queensland .....	<i>Cherax quadricarinatus</i>
Rock Lobster .....	<i>Jasus</i> and <i>Panulirus</i> spp.
Rock Lobster, Ornate .....	<i>Panulirus ornatus</i>
Rock Lobster, Southern .....	<i>Jasus novaehollandiae</i> and <i>edwardsii</i>
Rock Lobster, Tropical .....	<i>Panulirus</i> spp. excluding <i>P. cygnus</i>
Rock Lobster, Western .....	<i>Panulirus cygnus</i>
Yabbie, Common .....	<i>Cherax destructor</i>
Yabbie, White .....	<i>Cherax albidus</i>

[Division 3 amended in Gazette 30 Aug 1996 p. 4321; 15 Jan 1999  
 p. 113; 21 Dec 1999 p. 6410; 13 Dec 2002 p. 5798; 22 Dec 2005  
 p. 6239; 13 Nov 2007 p. 5692-3; 24 Feb 2012 p. 803.]

**Fish Resources Management Regulations 1995**

**Schedule 7** List of common and scientific names

**Division 4** Molluscs

---

**Division 4 — Molluscs**

[Heading inserted in Gazette 13 Nov 2007 p. 5693.]

---

<b>Common name</b>	<b>Scientific name</b>
<b>CEPHALOPODS</b>	
Cuttlefish .....	<u>Sub-class</u> Coleoidea <u>Order</u> Sepioidea
Octopus .....	<u>Sub-class</u> Coleoidea <u>Order</u> Octopoda
Squid .....	<u>Sub-class</u> Coleoidea <u>Order</u> Teuthoidea
<b>GASTROPODS</b>	
Abalone (all species) .....	<i>Haliotis</i> spp.
Abalone, Brownlip .....	<i>Haliotis conicopora</i>
Abalone, Greenlip .....	<i>Haliotis laevigata</i>
Abalone, Roe's .....	<i>Haliotis roei</i>
Conch .....	<u>Family</u> Stromidae
Trochus .....	<i>Tectus niloticus</i>
Volute .....	<u>Family</u> Volutidae
Zoila Cowry .....	<u>Family</u> Cypraeidae
<b>BIVALVES</b>	
Ark Shell .....	<u>Family</u> Arcidae
Clam, Giant .....	Family Tridacnidae
Clam, Venus .....	<u>Family</u> Veneridae, Katelysia spp.
Cockle .....	<u>Family</u> Cardiidae
Mussel .....	<u>Family</u> Mytilidae
Mussel, Blue .....	<i>Mytilus edulis</i>
Oyster .....	<u>Family</u> Ostreidae
Pipis .....	<u>Family</u> Donacidae
Razor shell.....	<u>Family</u> Pinnidae
Scallop .....	<u>Family</u> Pectinidae

---

[Division 4 amended in Gazette 23 Apr 1999 p. 1716; 4 Jun 1999 p. 2271; 1 Oct 2003 p. 4343; 30 Sep 2004 p. 4187; 13 Nov 2007 p. 5693-4; 29 Sep 2009 p. 3875; 23 Jul 2010 p. 3406; 29 Jan 2013 p. 319; 30 May 2014 p. 1724.]

**Division 5 — Other**

*[Heading inserted in Gazette 13 Nov 2007 p. 5693.]*

<b>Common name</b>	<b>Scientific name</b>
Bloodworm.....	<i>Polycirrus spp.</i>
Coral .....	<u>Class</u> Anthozoa and <u>Class</u> Hydrozoa
Live Rock .....	<u>Family</u> Corallinaceae, <u>Class</u> Polychaeta, <u>Class</u> Crinoidea, <u>Class</u> Ascidiacea, <u>Class</u> Ophiuroidea, <u>Phylum</u> Bryozoa and <u>Phylum</u> Porifera and dead fish of <u>Class</u> Anthozoa and <u>Class</u> Hydrozoa
Sea Cucumber (Beche-de-mer, Trepang) .....	<u>Class</u> Holothurioidae
Sea Urchin .....	<u>Class</u> Echinoidea

*[Division 5 amended in Gazette 13 Nov 2007 p. 5694; 13 Feb 2009  
p. 300; 29 Sep 2009 p. 3875; 29 Jan 2013 p. 319.]*

## Schedule 8

[reg. 151]

### Determination of characteristics of fish

#### Part 1 — Length

---

<b>Column 1</b>	<b>Column 2</b>
<b>Name of fish</b>	<b>Method of determining length</b>
1. Cobbler (Estuary Catfish) and Freshwater Cobbler	By measuring in a direct line — (a) for partial length, from the base of the anterior edge of the caudo dorsal fin to the tip of the tail; and (b) for total length, from the point of the snout, excluding the barbels, to the tip of the tail.
2. Crab, Champagne Crab, Giant	By measuring from the inside of the frontal groove midway between the eyes on the anterior margin of the carapace along the mid-ventral line of the carapace to the posterior margin where it joins the abdomen.
2a. Crab, Crystal	By measuring across the carapace at the widest point.
2b. Crab, any other	By measuring from tip to tip of the posterior carapace spikes.
3. Garfish	By measuring from the tip of the upper jaw to the tip of the upper half of the tail.
4. Marron	By measuring from the tip of the rostrum to the posterior margin of the carapace along the mid-dorsal line.
5. Prawn	By measuring along the body from the eye to the tip of the tail.
6. Southern Rock Lobster	By measuring from the anterior surface of the median suture of the frontal tubercle to the mid point of the posterior edge of the dorsal region of the carapace.

<b>Column 1</b>	<b>Column 2</b>
<b>Name of fish</b>	<b>Method of determining length</b>
7. Western and Tropical Rock Lobster	By measuring along the mid-dorsal line from the anterior edge of the pronounced ridge which joins the front edges of the rostral horns (immediately posterior to the eye stalks) to the posterior margin of the carapace.
8. Abalone	By measuring the shell from edge to edge across the longest diameter.
9. Trochus	By measuring the base from edge to edge across the longest diameter.
10. Any other fish	By measuring from the point of the snout to the tip of the tail.

*[Part 1 amended in Gazette 15 Jan 1999 p. 113; 13 Nov 2007 p. 5694.]*

### **Part 2 — Method of determining the volume of fish**

The volume of space which is filled by whole, undamaged fish without compressing those fish.

### **Part 3 — Method of determining the length of fish trunks and fillets**

*[Heading inserted in Gazette 4 Nov 2005 p. 5317.]*

A fish trunk or fillet is to be measured —

- (a) when the fish is lying flat; and
- (b) without being held; and
- (c) lengthwise along the longest part of the fish to which both the skin and the flesh of the fish extends; and
- (d) in the case of a fillet, the measurement is not to include any part of the head or tail of the fish still attached.

*[Part 3 inserted in Gazette 4 Nov 2005 p. 5317.]*

**Schedule 9 — Determining the value of fish**

[s. 222(2) and r. 157]

[Heading inserted in Gazette 29 Sep 2009 p. 3875.]

Species of fish	Value per unit of weight (\$/kgm)	Value per fish (\$)
Abalone, Brownlip (shucked) .....	90.00	24.00
Abalone, Brownlip (whole weight) .....	36.00	24.00
Abalone, Greenlip (shucked) .....	110.00	25.00
Abalone, Greenlip (whole weight) .....	40.00	25.00
Abalone, Roe's (shucked) .....	60.00	3.00
Abalone, Roe's (whole weight) .....	25.00	3.00
Amberjack .....	2.00	10.00
Ark Shell .....	10.00	0.25
Barracuda .....	2.00	10.00
Barramundi .....	14.50	58.00
Boarfish .....	8.00	24.00
Bonito .....	1.50	5.00
Bream, Black .....	9.00	5.00
Bream, Fingermark .....	5.00	10.00
Bream, Northwest-Black .....	6.00	12.00
Bream, Yellowfin .....	6.50	3.00
Catfish .....	5.00	3.00
Cherabin .....	7.00	0.30
Clam, Venus .....	8.00	0.20
Cobbler (Estuary Catfish) .....	6.50	4.00
Cobia .....	3.50	35.00
Cockle Shell .....	3.00	0.10
Cod, Breaksea .....	7.00	14.00
Cod, Estuary .....	7.00	42.00
Cod, Grey Banded Rock .....	9.00	54.00
Cod, Potato .....	10.00	100.00
Cod, Rankin .....	9.50	38.00
Coral .....	80.00	-
Coral Trout .....	20.00	45.00
Crab, Blue Manna (Blue Swimmer) .....	10.00	4.00
Crab, Champagne .....	15.00	30.00
Crab, Crystal .....	20.00	50.00

**Fish Resources Management Regulations 1995**  
 Determining the value of fish **Schedule 9**

<b>Species of fish</b>	<b>Value per unit of weight (\$/kgm)</b>	<b>Value per fish (\$)</b>
Crab, Giant .....	35.00	115.00
Crab, Mud (Brown) .....	25.00	14.00
Crab, Mud (Green) .....	25.00	14.00
Cuttlefish .....	5.00	3.00
Dart .....	1.00	1.00
Dhufish, West Australian .....	18.00	72.00
Dolphinfish (Mahi Mahi) .....	2.00	4.00
Dory, John .....	9.00	18.00
Emperor, Bluespotted .....	5.00	12.00
Emperor, Blue-lined .....	4.00	10.00
Emperor, Red .....	13.00	39.00
Emperor, Spangled .....	7.00	17.50
Flathead .....	6.00	5.00
Flounder .....	11.00	5.00
Foxfish, Western .....	5.50	3.00
Garfish .....	7.00	2.50
Goatfish .....	4.00	2.00
Groper, Baldchin .....	12.00	36.00
Groper, Bass .....	8.50	51.00
Groper, Queensland .....	10.00	100.00
Groper, Western Blue .....	6.00	48.00
Grunter, Sooty.....	5.00	2.50
Hapuku .....	6.00	48.00
Hardyhead .....	3.00	0.50
Harlequin Fish .....	7.00	7.00
Herring, Australian (Tommy Ruff) .....	4.50	2.00
Javelinfish .....	5.00	5.00
Kingfish, Yellowtail .....	1.50	7.50
Leafy Seadragon .....	-	100.00
Leatherjacket .....	2.00	2.00
Live Rock .....	8.00	-
Longtom .....	1.00	0.50
Mackerel, Blue (Common) .....	3.00	2.00
Mackerel, Broad-barred Spanish .....	11.00	44.00
Mackerel, Narrow-barred Spanish .....	11.00	44.00
Mackerel, Shark .....	1.00	4.00

**Fish Resources Management Regulations 1995****Schedule 9** Determining the value of fish

<b>Species of fish</b>	<b>Value per unit of weight (\$/kgm)</b>	<b>Value per fish (\$)</b>
Mackerel, Wahoo .....	7.00	28.00
Mangrove Jack .....	5.50	14.00
Marlin .....	2.00	100.00
Marron .....	36.00	5.00
Mullet .....	4.50	3.00
Mulloway .....	6.00	15.00
Mulloway, Northern .....	6.00	15.00
Mussel .....	3.00	0.10
Nannygai .....	9.50	20.00
Octopus .....	12.00	6.00
Oyster .....	10.00	0.60
Parrot Fish .....	6.00	12.00
Pearl Perch .....	9.00	18.00
Pigfish .....	3.00	1.50
Pike .....	6.00	2.00
Pilchard .....	3.00	0.50
Pipi .....	3.00	0.10
Prawn, Brown Tiger .....	15.00	1.00
Prawn, Western King .....	13.00	1.00
Prawn, Western School .....	4.00	0.50
Prawn (other) .....	8.00	0.50
Queenfish .....	3.00	10.00
Rays .....	4.00	60.00
Razor shell .....	5.00	1.00
Rock Lobster .....	50.00	25.00
Rock Lobster (tail weight) .....	60.00	15.00
Sailfish .....	1.00	40.00
Salmon, Australian .....	1.50	3.75
Samson Fish (Sea Kingfish) .....	2.00	10.00
Sawfish .....	10.00	500.00
Scallop (shucked) .....	18.00	0.50
Scallop (whole weight) .....	3.60	0.50
Sea Cucumber (Beche-de-mer, Trepang) .....	9.50	4.00
Sea Urchin .....	20.00	2.00
Shark, Great White .....	10.00	500.00
Shark, Spertooth .....	10.00	500.00



**Fish Resources Management Regulations 1995**  
 Determining the value of fish **Schedule 9**

<b>Species of fish</b>	<b>Value per unit of weight (\$/kgm)</b>	<b>Value per fish (\$)</b>
Shark, Whale .....	10.00	500.00
Sharks (other) .....	6.00	90.00
Snapper, Deep water .....	8.00	24.00
Snapper, Goldband .....	8.00	24.00
Snapper, Northwest .....	7.00	14.00
Snapper, Pink .....	9.50	28.50
Snapper, Queen (Blue Morwong) .....	3.50	8.75
Snapper, Red .....	6.00	6.00
Snook .....	3.00	1.50
Sole .....	6.00	2.50
Spearfish .....	1.00	25.00
Sprat, Sandy (Whitebait) .....	3.00	0.50
Squid .....	9.00	2.50
Swallowtail .....	3.50	3.00
Sweep, Banded .....	1.00	0.50
Sweep, Sea .....	3.00	2.00
Sweetlips .....	4.50	4.50
Swordfish .....	10.00	50.00
Tailor .....	7.00	5.00
Tarwhine (Silver Bream) .....	6.00	3.00
Threadfin, Blue .....	4.00	12.00
Threadfin, Giant .....	11.00	33.00
Trevalla .....	6.00	24.00
Trevally, Giant .....	3.50	8.00
Trevally, Golden .....	3.50	8.00
Trevally, Silver (Skipjack) .....	3.50	1.00
Trochus .....	9.50	2.00
Trout, Brown .....	7.00	3.00
Trout, Rainbow .....	7.00	3.00
Tripletail .....	8.00	20.00
Tuna, Albacore .....	3.50	14.00
Tuna, Bigeye .....	10.00	30.00
Tuna, Dogtooth .....	2.00	20.00
Tuna, Longtail (Northern Bluefin).....	5.00	25.00
Tuna, Skipjack .....	1.00	3.00
Tuna, Southern Bluefin .....	9.00	18.00

**Fish Resources Management Regulations 1995**  
**Schedule 9** Determining the value of fish

<b>Species of fish</b>	<b>Value per unit of weight (\$/kgm)</b>	<b>Value per fish (\$)</b>
Tuna, Yellowfin .....	9.50	19.00
Tuskfish .....	6.00	18.00
Weedy Seadragon .....	-	100.00
Whiting, King George (Spotted) .....	20.00	8.00
Whiting, Yellow-finned .....	6.00	1.50
Whiting (other) .....	6.50	1.70
Wrasse, Brown spot .....	5.00	2.00
Wrasse, Humphead Maori .....	25.00	100.00
Wrasse, King .....	3.00	2.00
Yabbie .....	12.00	2.00
Zoila Cowry .....	-	50.00
All fish not otherwise listed in this Schedule	1.00	1.00

*[Schedule 9 inserted in Gazette 29 Sep 2009 p. 3875-82; amended in Gazette 1 Mar 2011 p. 675; 24 Aug 2011 p. 3409; 24 Feb 2012 p. 803; 22 Jun 2012 p. 2779; 30 May 2014 p. 1724.]*

## **Schedule 10**

[reg. 176]

### **Non-endemic species of fish permitted to be brought into the State**

#### **Part 1 — Species of fish endemic to areas of Australia outside the State**

1. Cod, Murray
2. Eel, Short-finned
3. Perch, Golden
4. Perch, Silver
5. Redclaw, Queensland
6. Yabbie, Common
7. Yabbie, White

#### **Part 2 — Species of fish not endemic to Australia**

1. Perch, Redfin
2. Salmon, Atlantic
3. Trout, Brown
4. Trout, Rainbow

## **Schedule 11**

[reg. 59]

### **Authorised trade names of fish**

<b>Fish</b>	<b>Trade name</b>
Barramundi	Barramundi
Dhufish, West Australian	Dhufish

*[Schedule 11 amended in Gazette 1 Oct 2003 p. 4345.]*

**Schedule 12**  
**Modified penalties**

[s. 229(2) and reg. 162]

<b>Offence</b>	<b>Modified penalty \$</b>
<b>Part 1 — Sections of the Act</b>	
1A. Section 7(7), for a contravention of a condition of an exemption granted for purposes mentioned in section 7(2)(e) .....	750.00
1. Section 43(3), relating to —	
(a) category 1 fish .....	400.00
(b) category 2 fish .....	200.00
(c) category 3 fish .....	100.00
(d) category 4 fish .....	50.00
2. Section 46, relating to —	
(a) a quantity of category 1 fish that is less than or equal to the notional bag limit .....	200.00
(b) a quantity of category 1 fish that is more than the notional bag limit .....	1 000.00
(c) a quantity of category 2 fish that is less than or equal to the notional bag limit .....	100.00
(d) a quantity of category 2 fish that is more than the notional bag limit .....	500.00
(e) a quantity of category 3 fish that is less than or equal to the notional bag limit .....	75.00
(f) a quantity of category 3 fish that is more than the notional bag limit .....	375.00
(g) a quantity of category 4 fish that is less than or equal to the notional bag limit .....	50.00
(h) a quantity of category 4 fish that is more than the notional bag limit .....	200.00
3. Section 47, relating to —	
(a) category 1 fish .....	200.00
(b) category 2 fish .....	100.00
(c) category 3 fish .....	75.00
(d) category 4 fish .....	50.00
4A. Section 48A, relating to category 1 fish .....	500.00
4. Section 49 .....	200.00

<b>Offence</b>	<b>Modified penalty \$</b>
<b>Part 1 — Sections of the Act</b>	
5. Section 50(3), relating to —	
(a) a quantity of category 1 fish that is less than or equal to twice the bag limit .....	200.00
(b) a quantity of category 1 fish that is more than twice the bag limit .....	1 000.00
(c) a quantity of category 2 fish that is less than or equal to twice the bag limit .....	100.00
(d) a quantity of category 2 fish that is more than twice the bag limit .....	500.00
(e) a quantity of category 3 fish that is less than or equal to twice the bag limit .....	75.00
(f) a quantity of category 3 fish that is more than twice the bag limit .....	375.00
(g) a quantity of category 4 fish that is less than or equal to twice the bag limit .....	50.00
(h) a quantity of category 4 fish that is more than twice the bag limit .....	200.00
6. Section 51(2), relating to —	
(a) a quantity of category 1 fish that is less than or equal to twice the possession limit .....	200.00
(b) a quantity of category 1 fish that is more than twice the possession limit .....	1 000.00
(c) a quantity of category 2 fish that is less than or equal to twice the possession limit .....	100.00
(d) a quantity of category 2 fish that is more than twice the possession limit .....	500.00
(e) a quantity of category 3 fish that is less than or equal to twice the possession limit .....	75.00
(f) a quantity of category 3 fish that is more than twice the possession limit .....	375.00
(g) a quantity of category 4 fish that is less than or equal to twice the possession limit .....	50.00
(h) a quantity of category 4 fish that is more than twice the possession limit .....	200.00

Offence	Modified penalty \$
<b>Part 1 — Sections of the Act</b>	
7AA. Section 74(2), for a contravention of —	
(a) a provision of a management plan that prohibits a person from doing any thing in excess of an entitlement .....	3 000.00
(b) any other provision of a management plan .....	750.00
7AB. Section 77(2) .....	750.00
7A. Section 96 .....	400.00
7. Section 104 .....	200.00
8. Section 105 .....	200.00
9. Section 106(2) .....	200.00
10. Section 170(1) .....	200.00
11. Section 171(1) .....	200.00
12. Section 172 .....	200.00
13. Section 190(2) .....	200.00

*[Part 1 amended in Gazette 13 Feb 2009 p. 300; 24 Feb 2012 p. 803; 18 Dec 2012 p. 6591; 18 Jun 2013 p. 2297-9; 27 Aug 2013 p. 4057.]*

Offence	Modified penalty \$
<b>Part 2 — Regulations</b>	
1. Regulation 108 .....	50
2. Regulations 12(3), 16B, 39, 40, 42, 43, 44 and 64L .....	75
3. Regulations 14(1), 14(3), 14(4), 22, 32(1), 44A(2), 55F(1), 56, 60, 61, 64F, 64G, 64H, 64I(5), 64J, 64K, 64Q, 74, 75, 77, 79, 80, 81, 84, 85, 86, 91, 96, 97, 98, 99, 100, 101, 102, 103, 104, 105, 106, 107, 109, 110, 112, 113, 113AA, 113AB, 113A(5), 113A(6), 113B(2), 113B(3), 113C(2), 113E(3), 117(4), 128L(3), 128MA(2) and 144 .....	100
4. Regulations 12(1) and (2), 16E(3C), 16GA, 31(2), 31(3), 31(4), 31A(1), 35, 36(1), 38, 38B, 38C, 38D(2), 38D(3), 38E, 38F, 38GA, 41, 55I, 56A, 62, 63, 64, 64AA(2), 64C(1), 64DA, 64E, 64NA, 64O, 64OAA(2), 64OAA(3), 64OB, 64OD, 64OE, 64P, 71, 113A(1), 113A(2), 113A(4), 113B(1), 113C(1), 113E(1), 123(1), 124B(2), 128L(1), 128M, 128S(2) and 145 .....	200
5. Regulations 16E(3E), 38H, 38I(1), 38J, 38K, 38L, 38M,	

<b>Offence</b>	<b>Modified penalty \$</b>
<b>Part 2 — Regulations</b>	
38N(1), 38O(1), 45(2), 55G(1) and (2), 64S(1), 64S(3), 64T, 117(1), (2), (6), (7) and (8), 119(2) and (6), 121(1) and (2), 125(1) and (2), 128I, 128K, 128P, 128R and 128S(3) and (4) .....	400
6. Regulation 128O, relating to —	
(a) category 1 fish .....	400
(b) category 2 fish .....	200
(c) category 3 fish .....	100
(d) category 4 fish .....	100
7. Regulation 130(4), for a contravention of a condition of —	
(a) a fishing boat licence, carrier boat licence, commercial fishing licence or rock lobster pot licence .....	400.00
(b) any other licence granted under Part 11 .....	100.00
8. Regulation 59(2).....	500

*[Part 2 amended in Gazette 8 Sep 2000 p. 5188; 29 Dec 2000 p. 7979; 29 Jun 2001 p. 3179-80; 14 Nov 2001 p. 5979; 29 Nov 2002 p. 5655; 27 Jun 2003 p. 2394-5; 1 Oct 2003 p. 4345-6; 28 Nov 2003 p. 4776; 23 Dec 2003 p. 5206; 4 Nov 2005 p. 5317; 11 Nov 2005 p. 5566; 22 Dec 2005 p. 6239; 23 May 2006 p. 1861; 29 Dec 2006 p. 5892; 6 Jul 2007 p. 3389; 4 Sep 2007 p. 4521; 21 Dec 2007 p. 6326; 19 Dec 2008 p. 5363; 3 Jul 2009 p. 2680; 29 Sep 2009 p. 3882; 8 Dec 2009 p. 4997-8; 12 Feb 2010 p. 587; 27 Aug 2010 p. 4107; 1 Mar 2011 p. 672-3; 2 Nov 2011 p. 4625; 18 Dec 2012 p. 6591-2; 29 Jan 2013 p. 319; 28 Jun 2013 p. 2894; 27 Aug 2013 p. 4057; 30 May 2014 p. 1724-5 and 1737; 12 Aug 2014 p. 2907.]*



## Schedule 13

[reg. 38]

### Specifications for rock lobster pots

#### Part 1A — Preliminary

*[Heading inserted in Gazette 28 Jun 2013 p. 2894.]*

**1A. Term used: relevant minimum gap**

In this Schedule —

*relevant minimum gap* means —

- (a) in relation to a lobster pot used in connection with the West Coast Rock Lobster Managed Fishery, 55 mm;
- (b) in relation to all other lobster pots, 54 mm.

*[Clause 1A inserted in Gazette 28 Jun 2013 p. 2894; amended in Gazette 4 Sep 2013 p. 4183.]*

#### Part 1 — Waters north of 21° 44' south latitude

**1. Entrance or neck of pot**

Every rock lobster pot must —

- (a) have only one entrance or neck; and
- (b) not contain any device capable of restricting the egress of fish.

#### Part 2 — Waters between 21° 44' south latitude and 34° 24' south latitude (excluding some waters off the South Coast)

*[2A. Deleted in Gazette 27 Aug 2010 p. 4107.]*

**2. Entrance or neck of pot**

- (1) A rock lobster pot is to have only one entrance or neck which is to be positioned on the upper surface of the pot with the entrance or neck parallel to the base of the pot and is to be constructed wholly of a rigid material and with an opening throughout of not less than —

**Fish Resources Management Regulations 1995**

**Schedule 13** Specifications for rock lobster pots

**Part 2** Waters between 21° 44' south latitude and 34° 24' south latitude (excluding some waters off the South Coast)

**cl. 3**

---

- (a) where the entrance or neck is circular, 160 mm diameter; or
- (b) where the entrance or neck is rectangular, 160 mm by 160 mm,

and must not contain any device capable of restricting the egress of fish.

- (2) A rock lobster pot does not fail to comply with the specification set out in this clause by reason only that it is constructed with, or has fitted to it, a sea lion exclusion device (as defined in regulation 38).

*[Clause 2 amended in Gazette 10 Nov 2006 p. 4710.]*

**3. Beehive pots**

- (1) This clause applies to beehive rock lobster pots.

- (2) Every beehive rock lobster pot —

- (a) is to have inserted in it a device or devices to create 3 escape gaps that are as nearly as practicable rectangular in shape and when measured internally each is to measure not less than 305 mm in length and not less than the relevant minimum gap in height (see Diagram 1 in the Table); and

*[(b) deleted]*

- (c) is not to have any obstruction positioned so as to restrict the movement of rock lobsters through the escape gaps or to reduce the internal measurement of the escape gaps, other than in the case of a pot constructed of cane or sticks, where one wire may pass vertically across each escape gap.

- (3) The escape gaps in a beehive rock lobster pot are to be —

- (a) positioned on the side of the pot so that the longer sides of the gaps are generally parallel to the base of the pot and the lower internal edge of the escape gaps are not more than 110 mm from the base of the pot and are to be positioned in accordance with Diagram 2(a) in the Table; and
- (b) located at least 150 mm away from the attachment point or points of the hauling rope and, where there are 2 attachment points, not between those points; and
- (c) of —

- 
- (i) steel flat-bar and constructed to the specifications set out in clause 4(7)(a); or
  - (ii) pressed steel or aluminium and constructed to the specifications set out in clause 4(7)(d).
- (4) A beehive rock lobster pot that is constructed using stick or cane or both stick and cane, unless approved by the CEO, is not to exceed, when measured externally —
- (a) 975 mm in diameter; and
  - (b) 470 mm in height.
- (5) In determining the external dimensions under subclause (4) the measuring points are those specified in Diagram 10 in the Table.
- (6) A beehive rock lobster pot that is constructed using a material other than stick or cane, is not to exceed, when measured internally —
- (a) 925 mm in diameter; and
  - (b) 420 mm in height.
- (7) In determining the internal dimensions under subclause (6) the measuring points are those specified in Diagram 11 in the Table.

*[Clause 3 amended in Gazette 29 Nov 2002 p. 5656; 6 Jul 2007 p. 3389-90; 5 Nov 2009 p. 4414; 27 Aug 2010 p. 4107; 25 Sep 2012 p. 4520; 28 Jun 2013 p. 2895.]*

#### **4. Batten pots**

- (1) This clause applies to batten rock lobster pots.
- (2) Subject to this clause, every batten rock lobster pot is to have inserted in it a device or devices to create a minimum of 3 escape gaps that are as nearly as practicable rectangular in shape, and when measured internally each measures not less than 305 mm in length and not less than the relevant minimum gap in height.
- (3) Where —
  - (a) escape gaps are fitted to 3 sides of the rock lobster pot in accordance with this clause, the combined length of those gaps is to be not less than 915 mm, unless otherwise permitted under this clause; or

**Fish Resources Management Regulations 1995**

**Schedule 13** Specifications for rock lobster pots

**Part 2** Waters between 21° 44' south latitude and 34° 24' south latitude (excluding some waters off the South Coast)

**cl. 4**

---

- (b) escape gaps are fitted to only 2 sides of the rock lobster pot the combined length of those gaps is to be not less than 1 220 mm, except as otherwise permitted under this clause.
- (4) Where —
- (a) 3 escape gaps are fitted, those gaps are to be positioned one on each side of the rock lobster pot, other than the base of the pot, in the rear half of the pot and one at the end of the pot opposite the hauling rope attachment point or points and are to be positioned in accordance with Diagram 3 in the Table; or
  - (b) 3 escape gaps are fitted, and the length of the rock lobster pot does not exceed 770 mm, those gaps are to be positioned one on each side of the pot, other than the base of the pot, and one at the end of the pot opposite the hauling rope attachment point or points.
- (5) Where —
- (a) 4 or more escape gaps are fitted, those gaps are to be positioned 2 on each side, other than the base of the pot or the end of the pot to which the hauling rope is attached, and the length of one of the gaps fitted to each side of the pot may be less than 305 mm provided that —
    - (i) the combined length of the 2 escape gaps on each side of the pot is not less than 610 mm; and
    - (ii) the smallest gap on each side of the pot is not less than 200 mm;or
  - (b) 4 or more escape gaps are fitted and 2 of those gaps are positioned across the entire width of the end of the rock lobster pot opposite the hauling rope attachment point or points, then the combined length of those gaps may be less than 610 mm provided that —
    - (i) the centre support of the end of the pot to which the escape gap is attached does not exceed 50 mm in width; and
    - (ii) the smallest gap is not less than 250 mm.

- 
- (6) When fitted to the rock lobster pot, the longer sides of the escape gaps are to be generally parallel to the base of the pot and the lower internal edges of the escape gaps are to be not more than 110 mm from the base of the pot.
- (7) Escape gaps are to be of —
- (a) steel flat-bar with a width of not less than 20 mm and a thickness of not less than 3 mm and not more than 6 mm and are to be constructed in accordance with Diagram 4 in the Table; or
  - (b) aluminium with a width of not less than 20 mm and a thickness of not less than 4 mm and not more than 6 mm and are to be constructed in accordance with Diagram 5 in the Table; or
  - (c) fibreglass with a thickness of not less than 3 mm and not more than 6 mm with reinforcing on the lip of the gap with a thickness of not less than 5 mm and not more than 8 mm and the widest measurement of the lip of the gap is not to exceed 12 mm and are to be constructed in accordance with Diagram 6 in the Table; or
  - (d) pressed steel or aluminium with a width of not less than 20 mm and a thickness of not less than 2 mm and not more than 3 mm, when incorporating an internal pressed lip of a depth not less than 6 mm or more than 10 mm and are to be constructed in accordance with Diagram 7 in the Table.
- (8) The material to which an escape gap is attached in the horizontal plane is not to be —
- (a) constructed of a material thicker than 13 mm; or
  - (b) in the horizontal plane, within 5 mm of the internal edge of the escape gap; or
  - (c) provided that the escape gap is attached internally to the framework running horizontally along the bottom of the pot and the bottom internal edge of the escape gap is not within 10 mm of the attachment material, then the material to which the gap is attached may be greater than 13 mm but not more than 25 mm in thickness.
- (9) A batten rock lobster pot, unless otherwise approved by the CEO, is not to exceed, when measured internally —

**Fish Resources Management Regulations 1995**

**Schedule 13** Specifications for rock lobster pots

**Part 2** Waters between 21° 44' south latitude and 34° 24' south latitude (excluding some waters off the South Coast)

**cl. 5**

---

- (a) 915 mm in length; or
- (b) 420 mm in height; or
- (c) 800 mm base width; or
- (d) 540 mm top width,

except that where the height of the pot is less than 420 mm, the top width of the pot may be increased by 5 mm for every 10 mm by which the height is reduced.

- (10) When determining the internal dimensions of a batten pot, the measuring points are those specified in Diagram 9 in the Table and if the end frames have been modified by cutting the corners of the frame to the pot or modified in some other way, the measuring points are to be projected points as if the end and side frames were not cut or modified and were in accordance with those of Diagram 9.

*[Clause 4 amended in Gazette 6 Jul 2007 p. 3389-90; 5 Nov 2009 p. 4414; 27 Aug 2010 p. 4107; 25 Sep 2012 p. 4520; 28 Jun 2013 p. 2895.]*

**5. Other pots**

- (1) This clause applies to rock lobster pots that are not beehive pots or batten pots.
- (2) A rock lobster pot is to have inserted in it a device or devices to create a minimum of 3 escape gaps that are as nearly as practicable rectangular in shape and when measured internally each is to measure not less than 305 mm in length and not less than the relevant minimum gap in height.
- (3) The escape gaps are to be positioned —
  - (a) one on each side, other than the base, in the rear half of the pot and one at the end of the pot opposite the hauling rope attachment point or points; and
  - (b) so that the longer sides of the gaps are generally parallel to the base of the pot and the lower internal edge of the escape gaps are no more than 110 mm from the base of the pot.
- (4) Escape gaps are to be constructed —
  - (a) of the materials and to the specifications set out in clause 4(7); or

- (b) of plastic with a thickness of not less than 3 mm and not more than 6 mm.
- (5) The material to which the escape gaps is attached in the horizontal plane is not to be —
  - (a) constructed of material thicker than 13 mm; or
  - (b) in the horizontal plane, within 5 mm of the internal edge of the escape gap.

*[Clause 5 amended in Gazette 29 Nov 2002 p. 5656; 5 Nov 2009 p. 4414; 12 Feb 2010 p. 588; 27 Aug 2010 p. 4107; 25 Sep 2012 p. 4521; 28 Jun 2013 p. 2895.]*

*[6. Deleted in Gazette 12 Feb 2010 p. 588.]*

**7. All pots**

- (1) This clause applies to all rock lobster pots.
- (2) A rock lobster pot is not to have any form of chamber or partition in the pot which is capable of containing rock lobster other than that formed by the external frame of the pot.
- (3) A rock lobster pot is not to have an internal volume, including that of any object enclosed in a pot such as a bait basket and neck and ballast in the frame of the pot, which is greater than 0.257 m<sup>3</sup>.
- (4) An escape gap is not to have any obstruction positioned in such a way as to restrict the movement of rock lobsters through the escape gap or to reduce the internal measurements of the escape gap, except as provided in clause 3(2)(c).

**Part 3 — All other waters**

**8. Entrance or neck of pot**

Unless otherwise approved by the CEO, a rock lobster pot is to have only one entrance or neck which is to be positioned on the upper surface of the pot with the entrance or neck parallel to the base of the pot and is to be constructed wholly of a rigid material and must not contain any device capable of restricting the egress of fish.

*[Clause 8 amended in Gazette 6 Jul 2007 p. 3389-90.]*

**9. Beehive pots**

- (1) This clause applies to beehive rock lobster pots.
- (2) Every beehive rock lobster pot —
  - (a) is to have inserted in it a device to create an escape gap that is as nearly as practicable rectangular in shape and when measured internally is not less than 305 mm in length and not less than the relevant minimum gap in height (see Diagram 1 in the Table); and
  - (b) is not to have any obstruction positioned so as to restrict the movement of rock lobsters through the escape gap or to reduce the internal measurement of the escape gap, other than in the case of a pot constructed of cane or sticks, where one wire may pass vertically across the escape gap.
- (3) The escape gap in a beehive rock lobster pot is to be —
  - (a) positioned on the side of the pot so that the longer sides of the gap are generally parallel to the base of the pot and the lower internal edge of the escape gap is not more than 110 mm from the base of the pot and is to be positioned in accordance with Diagram 2(b) in the Table; and
  - (b) located at least 150 mm away from the attachment point or points of the hauling rope and, where there are 2 attachment points, not between those points; and
  - (c) of —
    - (i) steel flat-bar and constructed to the specifications set out in clause 4(7)(a); or
    - (ii) pressed steel or aluminium and constructed to the specifications set out in clause 4(7)(d).

*[Clause 9 amended in Gazette 27 Aug 2010 p. 4107; 28 Jun 2013 p. 2896.]*

**10. Batten pots**

- (1) This clause applies to batten rock lobster pots.
- (2) Subject to this clause, every batten rock lobster pot is to have inserted in it a device to create an escape gap that is as nearly as practicable rectangular in shape, and when measured internally, is to measure not



less than 305 mm in length and not less than the relevant minimum gap in height.

- (3) The escape gap in a batten rock lobster pot is to be —
  - (a) positioned on a side of the pot, other than the base, in the rear half of the pot or at the end opposite the hauling rope attachment point or points and is to be positioned in accordance with Diagram 3 in the Table; and
  - (b) located at least 150 mm away from the attachment point or points of the hauling rope and, where there are 2 attachment points, not between those points.
- (4) When fitted to the rock lobster pot, the longer sides of the escape gap are to be generally parallel to the base of the pot and the lower internal edge of the escape gap is to be not more than 110 mm from the base of the pot.
- (5) An escape gap is to be constructed of the materials and to the specifications set out in clause 4(7).
- (6) The material to which an escape gap is attached in the horizontal plane is not to be —
  - (a) constructed of a material thicker than 13 mm; or
  - (b) in the horizontal plane, within 5 mm of the internal edge of the escape gap; or
  - (c) provided that the escape gap is attached internally to the framework running horizontally along the bottom of the pot and the bottom internal edge of the escape gap is not within 10 mm of the attachment material, then the material to which the gap is attached may be greater than 13 mm but not more than 25 mm in thickness.

*[Clause 10 amended in Gazette 27 Aug 2010 p. 4107; 28 Jun 2013 p. 2896.]*

## **11. Other pots**

- (1) This clause applies to rock lobster pots that are not beehive pots or batten pots.
- (2) A rock lobster pot is to have inserted in it a device to create an escape gap that is as nearly as practicable rectangular in shape and when

measured internally is to measure not less than 305 mm in length and not less than the relevant minimum gap in height.

- (3) The escape gap in a rock lobster pot is to be positioned —
- (a) on a side, other than the base, in the rear half of the pot opposite the hauling rope attachment point or points; and
  - (b) so that the longer sides of the gap are generally parallel to the base of the pot and the lower internal edge of the escape gap is no more than 110 mm from the base of the pot; and
  - (c) at least 150 mm away from the attachment point or points of the hauling rope and where there are 2 attachment points, not between those points.
- (4) An escape gap is to be constructed —
- (a) of the materials and to the specifications set out in clause 4(7); or
  - (b) of plastic with a thickness of not less than 3 mm and not more than 6 mm.
- (5) The material to which an escape gap is attached in the horizontal plane is not to be —
- (a) constructed of material which is thicker than 13 mm; or
  - (b) in the horizontal plane, within 5 mm of the internal edge of the escape gap.

*[Clause 11 amended in Gazette 12 Feb 2010 p. 588; 28 Jun 2013 p. 2896.]*

*[12. Deleted in Gazette 12 Feb 2010 p. 588.]*

**13. All pots**

- (1) This clause applies to all rock lobster pots.
- (2) A rock lobster pot is not to have any form of chamber or partition in the pot which is capable of containing rock lobster other than that formed by the external frame of the pot.
- (3) An escape gap is not to have any obstruction positioned in such a way as to restrict the movement of rock lobsters through the escape gap or to reduce the internal measurements of the escape gap, except as provided in clause 9(2)(b).

**Table**

**Diagram 1 — Beehive pots**

(Clauses 3(2)(a) and 9(2)(a))

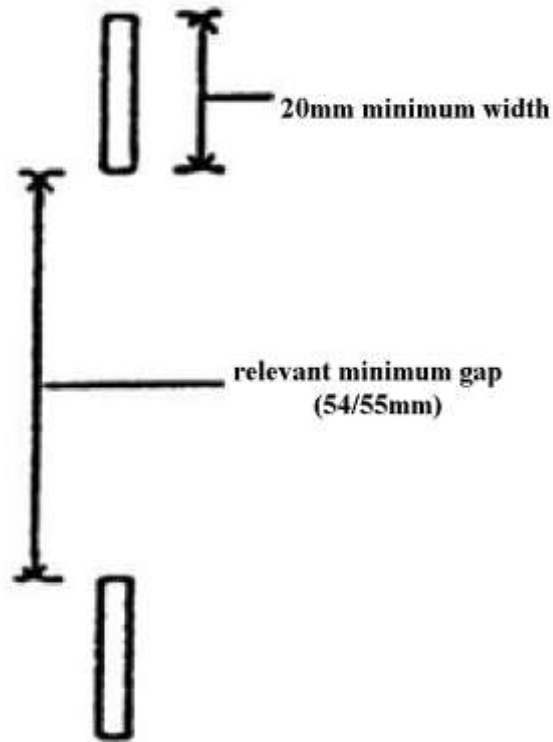

[Diagram 1 inserted in Gazette 28 Jun 2013 p. 2897.]

**Diagram 2(a) — Beehive pots**

(Clause 3(3)(a))

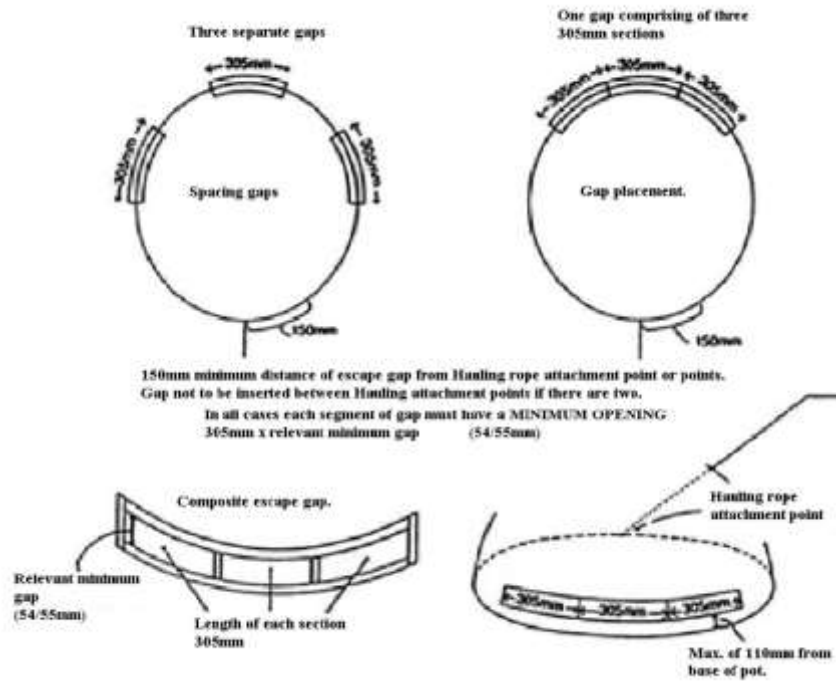

[Diagram 2(a) inserted in Gazette 28 Jun 2013 p. 2898.]

**Diagram 2(b) — Beehive pots**

(Clause 9(3)(a))

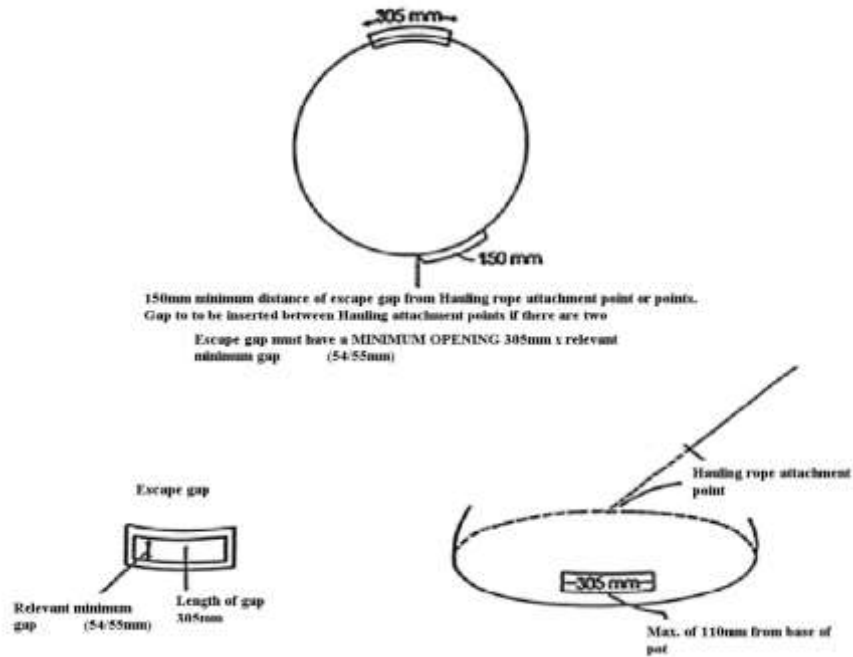

*[Diagram 2(b) inserted in Gazette 28 Jun 2013 p. 2899.]*

**Diagram 3 — Batten pots**  
(Clauses 4(4)(a) and 10(3)(a))

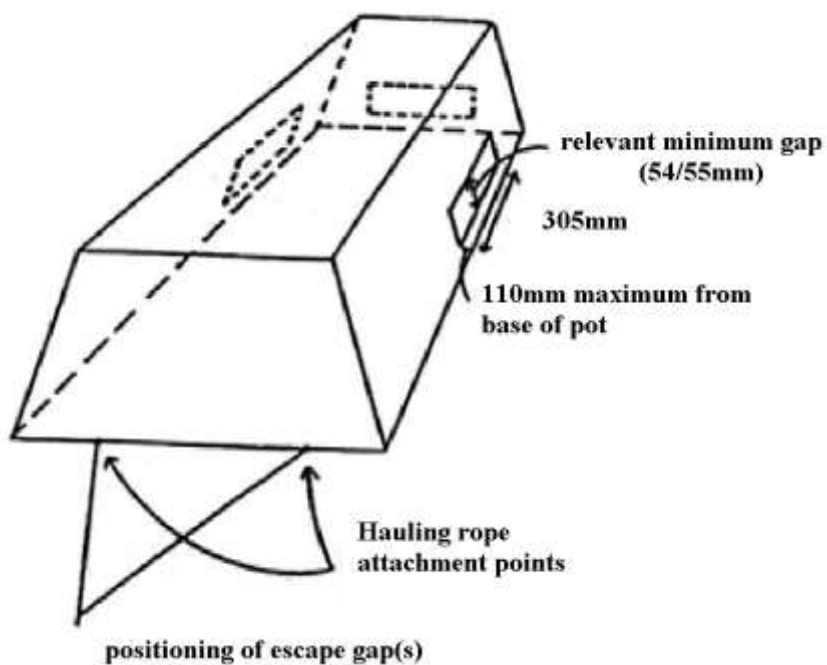

*[Diagram 3 inserted in Gazette 28 Jun 2013 p. 2900.]*

**Diagram 4 — Batten pots**

(Clause 4(7)(a))

(Steel flat - bar)

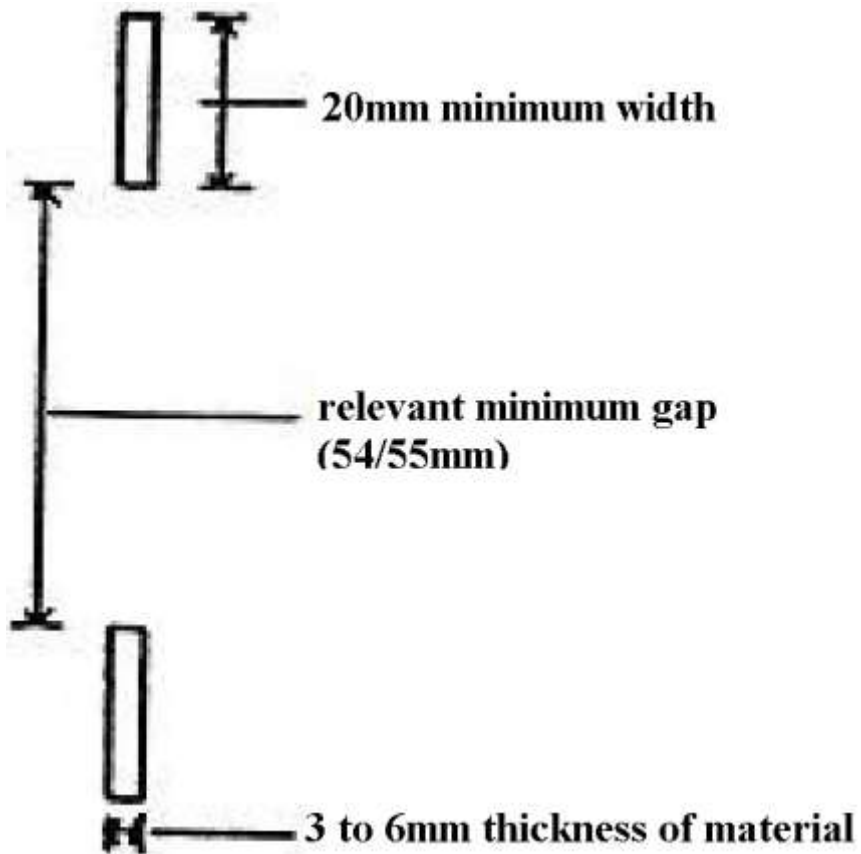

*[Diagram 4 inserted in Gazette 28 Jun 2013 p. 2901.]*

**Diagram 5 — Batten pots**

(Clause 4(7)(b))

(Aluminium)

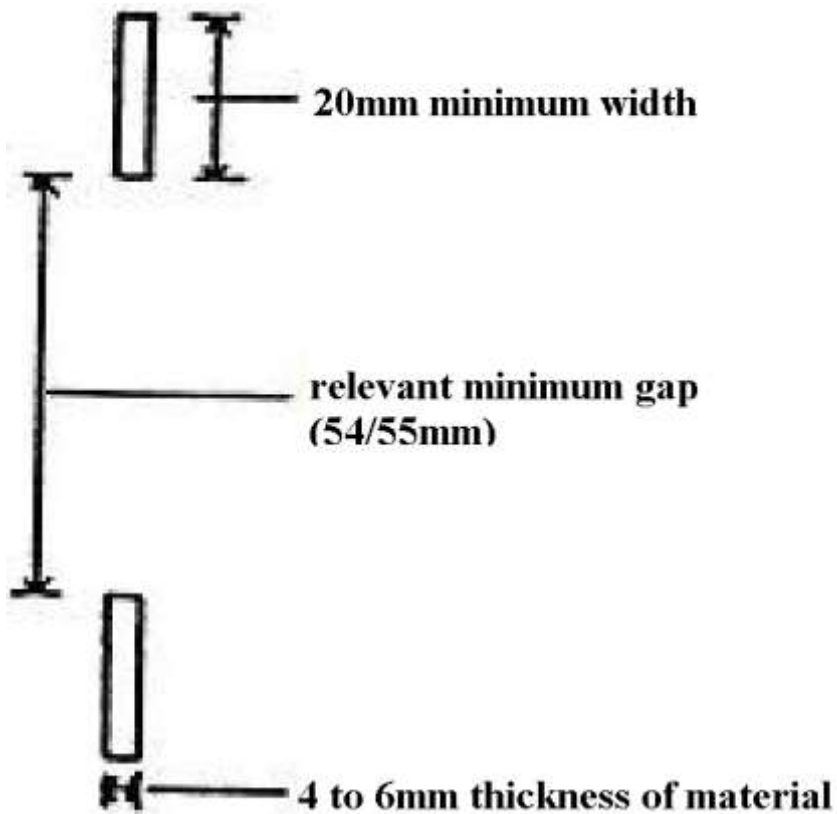

*[Diagram 5 inserted in Gazette 28 Jun 2013 p. 2902.]*



**Diagram 6 — Batten pots**

(Clause 4(7)(c))

(Fibreglass)

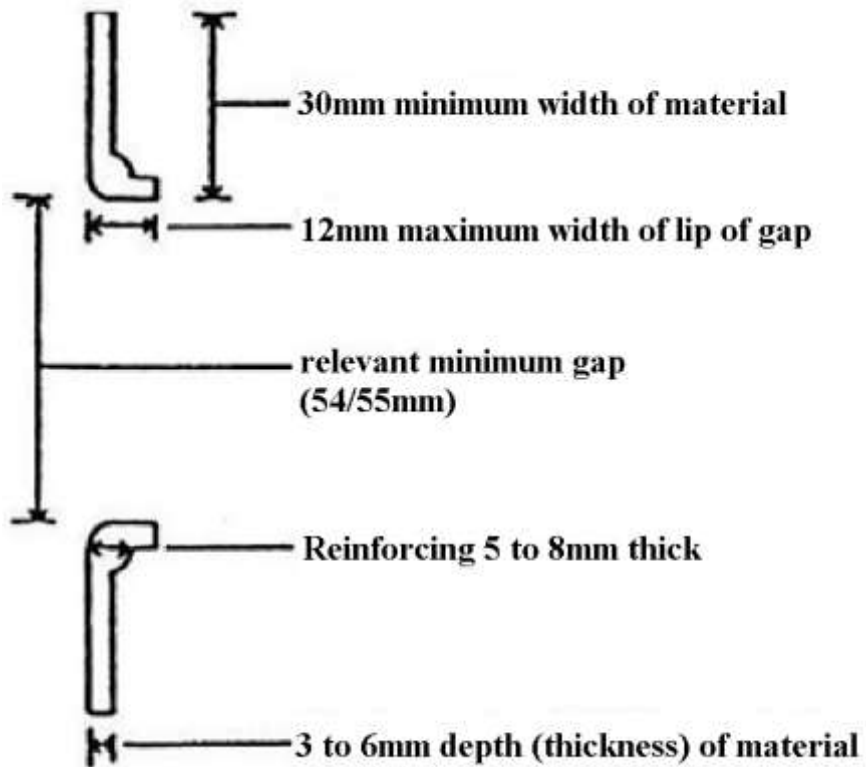

*[Diagram 6 inserted in Gazette 28 Jun 2013 p. 2903.]*

**Diagram 7 — Batten pots**  
(Clause 4(7)(d))  
(Steel or aluminium with internal lip)

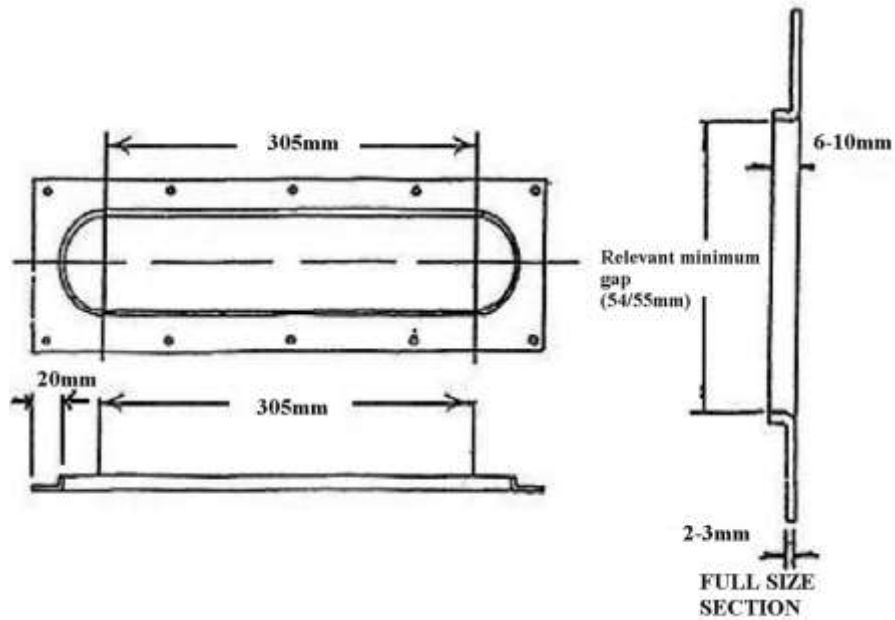

[Diagram 7 inserted in Gazette 28 Jun 2013 p. 2904.]

[Diagram 8 deleted in Gazette 12 Feb 2010 p. 588.]



**Diagram 11 — Beehive pots**  
(Clause 3(7))

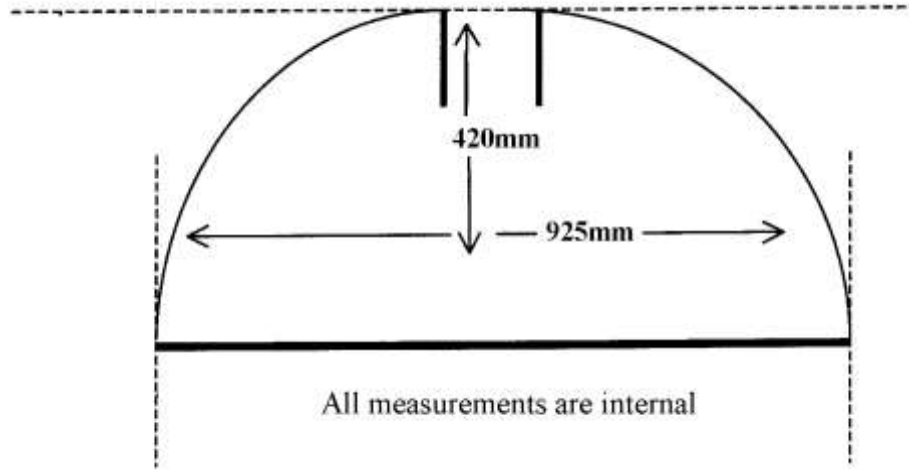

*[Diagram 11 inserted in Gazette 29 Nov 2002 p. 5657.]*

---

**Schedule 14**

**Forms**

[Form 1 deleted in Gazette 30 Dec 2004 p. 6965.]

**Form 2**

[reg. 147]

*Fish Resources Management Act 1994*  
(Section 187)

**WARRANT TO ENTER AND SEARCH**

This is a warrant authorising a fisheries officer to enter and search:

Place:	
Time: (specify hours or at any time)	
This warrant ceases to have effect:	
Date:	
Time:	

I ..... Justice of the Peace of .....  
am satisfied by application supported by evidence on oath —

- (a) that there are reasonable grounds for suspecting that there is on or in the place referred to in this warrant anything that may afford evidence of the commission of an offence against the *Fish Resources Management Act 1994*; or
- (b) that the issue of this warrant is reasonably required for the purpose of ascertaining whether a person has contravened or is contravening the *Fish Resources Management Act 1994*;

and I authorise ....., a fisheries officer, to enter and search the place referred to in this warrant with such assistance, and by such force, as is reasonably necessary during the time referred to in this warrant.

.....  
Signature of Justice of the Peace

.....  
Date

[Form 2 amended in Gazette 29 May 2008 p. 2059.]

**Form 3**

[reg. 160]

*Fish Resources Management Act 1994*  
(Section 229(1))

**INFRINGEMENT NOTICE**

No. of notice:  
Authorisation Nos.:

To:

Postcode:

It is alleged that you have committed an offence:

When and where:	When: a.m./p.m. on the day of 20 .
	Where:

**Details of the offence and modified penalty:**

Section of Act	Description of Offence	Modified Penalty \$
----------------	------------------------	---------------------------

What you must do:

1. You may dispose of this matter within 28 days of the service of this notice by paying the modified penalty in person at any Post Office or Post Office Agency.
- OR
2. Elect to have this matter dealt with before a COURT by completing the Court Election on the reverse side.

**Information about this notice:**

Issued at:	
by:	
Signature:	

**Election for Court**

To have this matter dealt with by a Court, complete the details on back of this form and send it to —

Prosecutions Officer  
Department of Fisheries  
3rd Floor, The Atrium  
168 St George's Terrace  
Locked Bag 39, Cloisters Square  
PERTH WA 6000

A summons will then be issued to you.

[Back of Form 3]

I elect to have this matter heard by a Court.

(Please use block letters)

Surname \_\_\_\_\_

Given Names \_\_\_\_\_

Address \_\_\_\_\_

Postcode \_\_\_\_\_

Signature \_\_\_\_\_

Date        \_\_\_\_/\_\_\_\_/\_\_\_\_

[Form 3 amended in Gazette 10 Nov 2006 p. 4710-11.]

**Form 4**

[reg. 161]

*Fish Resources Management Act 1994*  
(Section 231(1))

**WITHDRAWAL OF INFRINGEMENT NOTICE**

No. of notice:

To:

Postcode:

---

AN INFRINGEMENT NOTICE SERVED ON YOU HAS BEEN WITHDRAWN AND NO FURTHER ACTION WILL BE TAKEN\*/ A SUMMONS WILL BE ISSUED\*

Details of the withdrawn notice:

Date of service:	
Alleged offence:	
Notice No.:	

Information about this notice:

Issued at:	
by:	
Signature:	

\* Delete where not applicable.

**Form 5**

[reg. 165]

*Fish Resources Management Act 1994*  
(Section 249(3)(a))

**NOTICE TO ATTEND OR PRODUCE DOCUMENTS**

No. of notice:

To:

Postcode:

An inquiry is being conducted by an appointed person under section 249(3)(a) of the Act.

The inquiry is about:	
-----------------------	--

What you must do:	
You must:	
Attend before the appointed person: <input type="checkbox"/>	
Produce the following documents before the appointed person: <input type="checkbox"/>	

Information about the inquiry:	
Where you must go:	
When:	Time      Date      Month      Year and then from day to day until the end of the inquiry or until excused by the appointed person.

Information about this notice:	
Issued at:	Date:
by:	(appointed person)
Signature:	
Telephone contact:	

If you do not attend or produce the documents:

It is an offence not to comply with this summons unless you have a reasonable excuse.

The maximum penalty to which you may be liable is \$5 000.



**Form 6**

[reg. 173]

*Fish Resources Management Act 1994*  
(Section 255(1))

**NOTICE PROHIBITING ACTIVITIES THAT POLLUTE WATERS**

To: \_\_\_\_\_ No. of Notice: \_\_\_\_\_  
Postcode: \_\_\_\_\_

You are prohibited from engaging in the following activity which is polluting, or likely to pollute, the aquatic environment:

\_\_\_\_\_

**Information about the prohibition:**

Period of prohibition:	
Circumstances and times:	

**Information about this notice:**

Issued at:		
by:		The Minister for Fisheries
Signature:		
Telephone contact:		

If you contravene this notice:

\_\_\_\_\_

It is an offence to contravene this notice.

The maximum penalty to which you may be liable is:

For an individual:        \$25 000.  
For a body corporate:     \$50 000.

\_\_\_\_\_

**Form 7**

[reg. 174]

*Fish Resources Management Act 1994*  
(Section 255(2)(c))

**NOTICE TO VARY OR REVOKE A NOTICE PROHIBITING  
ACTIVITIES THAT POLLUTE WATERS**

To: \_\_\_\_\_ No. of notice: \_\_\_\_\_  
Postcode: \_\_\_\_\_

The notice served on you prohibiting you from an activity that was polluting, or likely to pollute, the aquatic environment is varied\*/revoked\* —

Which notice is varied/revoked?

No. of notice:	Date:
Served:	
By:	
Time:	

\*\*This is the variation of the notice.

**Information about this notice:**

Issued at:	
by:	The Minister for Fisheries
Signature:	
Telephone contact:	

If you contravene this notice:

It is an offence to contravene this notice.

The maximum penalty to which you may be liable is:

For an individual: \$25 000.  
For a body corporate: \$50 000.

\* Delete where not applicable.

\*\* Score through this section if not applicable.

**Form 8**

[r. 144E(5)(b)(ii)]

*Fish Resources Management Act 1994*

**DECLARATION REGARDING  
MORTALITY AND DISEASE OF PEARL OYSTERS**

Name: \_\_\_\_\_

Address: \_\_\_\_\_

Phone no: \_\_\_\_\_

I declare that:

1.    The sample of pearl oysters with which this declaration is submitted was taken on \_\_\_\_\_ from pearl oysters being held at  
      (*location of hatchery, quarantine site etc.*)  
      \_\_\_\_\_  
      \_\_\_\_\_
  
2.    No unexplained mortalities have occurred, and no signs of clinical disease have been seen, in the last 12 months among pearl oysters being held at that place.

Signature: \_\_\_\_\_

Date: \_\_\_\_\_

*[Form 8 inserted in Gazette 24 Sep 2013 p. 4450-1.]*

**Form 9**

[r. 144F(4)]

*Fish Resources Management Act 1994*

**CERTIFICATE OF HEALTH — PEARL OYSTERS**

Name: \_\_\_\_\_

Address: \_\_\_\_\_

---

Phone no: \_\_\_\_\_

I am an approved fish pathologist and certify that:

1. This certificate has been issued in respect of a sample of pearl oysters marked \_\_\_\_\_ which was taken from pearl oysters being held at (*location of hatchery, quarantine site etc.*) \_\_\_\_\_ The sample was delivered to me for disease testing on \_\_\_\_\_ by \_\_\_\_\_
2. I have no reason to doubt the information given as to the origins of the pearl oysters or the levels of mortality or clinical disease in the hatchery, quarantine site or other place where the pearl oysters are being held.
3. The following tests were carried out for clinical disease or significant pathogens.

Test	Number tested	Date	Result

4. No clinical disease or significant pathogen was detected in the sample.
- 5.\* The following genetic tests were carried out \_\_\_\_\_

\_\_\_\_\_

with the following results \_\_\_\_\_

\_\_\_\_\_

and no genetic components not of Western Australian origin were detected.

\* Delete if inapplicable.

Signature: \_\_\_\_\_  
Approved fish pathologist

Date: \_\_\_\_\_

OFFICE USE ONLY

1.AHL No: \_\_\_\_\_

2.Name of licensee or permit holder: \_\_\_\_\_

*[Form 9 inserted in Gazette 24 Sep 2013 p. 4451-2.]*

## **Schedule 15 — Tour management zones**

[r. 128J]

*[Heading inserted in Gazette 29 Jun 2001 p. 3180; amended in Gazette 30 May 2014 p. 1737.]*

**1. Zone 1: Pilbara/Kimberley**

Pilbara and Kimberley Region

*[Clause 1 inserted in Gazette 1 Oct 2003 p. 4346.]*

**2. Zone 2: Gascoyne**

Gascoyne Region

*[Clause 2 inserted in Gazette 1 Oct 2003 p. 4346; amended in Gazette 23 May 2006 p. 1861.]*

**3. Zone 3: West Coast**

All land and waters, and all waters off the coast of Western Australia south of 27° 00' south latitude but excluding the land and waters of Zone 4.

*[Clause 3 inserted in Gazette 29 Jun 2001 p. 3180.]*

**4. Zone 4: South Coast**

All land and waters, and the waters off the coast of Western Australia east of 115° 30' east longitude, south of 33° 32' south latitude, and west of the longitude passing through the border of Western Australia and South Australia.

*[Clause 4 inserted in Gazette 29 Jun 2001 p. 3181.]*

## **Schedule 16 — Abalone zones**

[r. 38DA]

*[Heading inserted in Gazette 10 Nov 2006 p. 4711; amended in Gazette 27 Aug 2013 p. 4057.]*

**1. Abalone Zone 1: Busselton Jetty to Greenough River mouth**

All —

- (a) WA waters; and
- (b) all land in the State,

that are on the seaward side of the high water mark and are —

- (c) in the area that is —
  - (i) south of 28° 51.9' south latitude; and
  - (ii) north of 33° 29' south latitude; and
  - (iii) west of the high water mark along the west coast between those 2 parallels;

or

- (d) in the area that is bounded by a line commencing at the intersection of 115° 20.675' east longitude and the high water mark in Geographe Bay (Busselton Jetty) and extending —
  - (i) north along that meridian to its intersection with 33° 29' south latitude; and
  - (ii) east along that parallel to its intersection with the high water mark; and
  - (iii) then generally south westerly along the high water mark to the intersection with 115° 20.675' east longitude.

*[Clause 1 inserted in Gazette 10 Nov 2006 p. 4711-12.]*

**2. Abalone Zone 2: Greenough River mouth to Northern Territory border**

All —

- (a) WA waters; and

**cl. 3**

---

(b) land in the State,

that are on the seaward side of the high water mark and north of 28° 51.9' south latitude.

*[Clause 2 inserted in Gazette 10 Nov 2006 p. 4712.]*

**3. Abalone Zone 3: Busselton Jetty to South Australian border**

All —

(a) WA waters; and

(b) land in the State,

that are on the seaward side of the high water mark and south of 28° 51.9' south latitude excluding Abalone Zone 1.

*[Clause 3 inserted in Gazette 10 Nov 2006 p. 4712.]*



## **Schedule 17 — Fish diseases**

[r. 3]

*[Heading inserted in Gazette 24 Sep 2013 p. 4453.]*

### **Division 1 — Diseases of crustaceans**

*[Heading inserted in Gazette 24 Sep 2013 p. 4453.]*

Crayfish plague  
GAV/LOV virus of prawns  
Infectious hypodermal and haemopoietic necrosis virus  
Infectious myonecrosis  
Microsporidiosis  
Milky haemolymph diseases of spiny lobster (*Panulirus* spp.)  
Monodon slow growth syndrome  
Necrotising hepatopancreatitis  
Taura syndrome  
White spot disease  
White tail disease  
Yellowhead disease

*[Division 1 inserted in Gazette 24 Sep 2013 p. 4453.]*

### **Division 2 — Diseases of molluscs**

*[Heading inserted in Gazette 24 Sep 2013 p. 4453.]*

Abalone viral ganglioneuritis  
Abalone viral mortality  
Acute viral necrosis in scallops  
Akoya oyster disease  
Bonamiosis

Haplosporidiosis

Infection with *Bonamia ostreae*

Infection with *Bonamia exitiosa*

Infection with *Marteilia refringens*

Infection with *Marteilioides chungmuensis*

Infection with *Perkinsus marinus*

Iridovirus

Marteiliosis

Mikrocytosis (*Mykrocytois mackini*)

Perkinsosis

Withering syndrome of abalone

*[Division 2 inserted in Gazette 24 Sep 2013 p. 4453-4.]*

**Division 3 — Diseases of other fish**

*[Heading inserted in Gazette 24 Sep 2013 p. 4454.]*

*Aeromonas salmonicida* infection (Goldfish ulcer disease)

*Aeromonas salmonicida* infection (Furunculosis)

Bacterial kidney disease (*Renibacterium salmoninarium*)

Channel catfish virus disease

Enteric redmouth disease (*Yersinia ruckeri*)

Enteric septicaemia of catfish (*Edwardsiella ictaluri*)

Epizootic haematopoietic necrosis — European catfish virus

Epizootic haemopoietic necrosis (Redfin virus)

Epizootic ulcerative syndrome

European sheatfish virus

Grouper iridoviral disease

Gyrodactylosis (*Gyrodactylus salaris*)

Herpesvirus infection of Koi carp

Infectious haematopoietic necrosis

Infectious pancreatic necrosis

Infectious salmon anaemia

Piscirickettsiosis

Red sea bream iridoviral disease

Spring viraemia of carp

Viral encephalopathy and retinopathy

Viral haemorrhagic septicaemia

Whirling disease of salmonids

*[Division 3 inserted in Gazette 24 Sep 2013 p. 4454-5.]*

**Schedule 18 — Diseases of pearl oysters**

[r. 144A]

*[Heading inserted in Gazette 24 Sep 2013 p. 4455.]*

Akoya oyster disease

Bonamiosis

Haplosporidiosis

Infection with *Bonamia ostreae*

Infection with *Bonamia exitiosa*

Infection with *Marteilia refringens*

Infection with *Marteilioides chungmuensis*

Infection with *Perkinsus marinus*

Iridovirus

Marteiliosis

Mikrocytosis (*Mykrocytois mackini*)

Oyster oedema disease

Perkinsosis

*[Schedule 18 inserted in Gazette 24 Sep 2013 p. 4455-6.]*

---

---

### Notes

<sup>1</sup> This is a compilation of the *Fish Resources Management Regulations 1995* and includes the amendments made by the other written laws referred to in the following table. The table also contains information about any reprint.

### Compilation table

Citation	Gazettal	Commencement
<i>Fish Resources Management Regulations 1995</i>	29 Sep 1995 p. 4503-646	1 Oct 1995 (see r. 2 and <i>Gazette</i> 29 Sep 1995 p. 4649)
<i>Fish Resources Management Amendment Regulations 1995</i>	22 Dec 1995 p. 6169	22 Dec 1995
<i>Fish Resources Management Amendment Regulations 1996</i>	30 Aug 1996 p. 4318-21	30 Aug 1996
<i>Fish Resources Management Amendment Regulations (No. 2) 1996</i>	24 Dec 1996 p. 7114	24 Dec 1996
<i>Fish Resources Management Amendment Regulations (No. 3) 1996</i>	24 Dec 1996 p. 7115	24 Dec 1996
<i>Fish Resources Management Amendment Regulations 1997</i>	27 Mar 1997 p. 1693-4	1 Apr 1997 (see r. 2)
<i>Fish Resources Management Amendment Regulations (No. 2) 1997</i>	4 Jul 1997 p. 3474-8	4 Jul 1997 (see r. 2)
<i>Fish Resources Management Amendment Regulations (No. 3) 1997</i>	12 Sep 1997 p. 5152-4	12 Sep 1997
<i>Fish Resources Management Amendment Regulations (No. 5) 1997</i>	30 Sep 1997 p. 5415-16	30 Sep 1997
<i>Fish Resources Management Amendment Regulations (No. 4) 1997</i>	30 Sep 1997 p. 5417-18	30 Sep 1997
<i>Fish Resources Management Amendment Regulations (No. 6) 1997</i>	5 Dec 1997 p. 7121-3	5 Dec 1997
<i>Fish Resources Management Amendment Regulations (No. 7) 1997</i>	5 Dec 1997 p. 7123	5 Dec 1997
<i>Fish Resources Management Regulations (No. 8) 1997</i>	2 Jan 1998 p. 25-8 (correction 9 Jan 1998 p. 205)	2 Jan 1998
<i>Fish Resources Management Amendment Regulations 1998</i>	19 Jun 1998 p. 3263-4	19 Jun 1998

## **Fish Resources Management Regulations 1995**

<b>Citation</b>	<b>Gazettal</b>	<b>Commencement</b>
<i>Fish Resources Management Amendment Regulations (No. 2) 1998</i>	7 Jul 1998 p. 3613-14	7 Jul 1998
<i>Fish Resources Management Amendment Regulations (No. 3) 1998</i>	25 Sep 1998 p. 5298-300	25 Sep 1998
<i>Fish Resources Management Amendment Regulations (No. 4) 1998</i>	15 Jan 1999 p. 112-13	15 Jan 1999
<i>Fish Resources Management Amendment Regulations 1999</i> <sup>6</sup>	26 Mar 1999 p. 1279-80	26 Mar 1999
<i>Fish Resources Management Amendment Regulations (No. 2) 1999</i>	23 Apr 1999 p. 1716	23 Apr 1999
<i>Fish Resources Management Amendment Regulations (No. 3) 1999</i>	4 Jun 1999 p. 2269-70	4 Jun 1999
<i>Fish Resources Management Amendment Regulations (No. 4) 1999</i>	4 Jun 1999 p. 2270-1	4 Jun 1999
<i>Fish Resources Management Amendment Regulations (No. 6) 1999</i>	13 Aug 1999 p. 3825-7	13 Aug 1999
<i>Fish Resources Management Amendment Regulations (No. 7) 1999</i>	28 Sep 1999 p. 4699	28 Sep 1999
<i>Fish Resources Management Amendment Regulations (No. 8) 1999</i>	21 Dec 1999 p. 6406-10	21 Dec 1999
<i>Fish Resources Management Amendment Regulations (No. 9) 1999</i>	21 Dec 1999 p. 6411	21 Dec 1999
<i>Fish Resources Management Amendment Regulations 2000</i>	7 Apr 2000 p. 1813-14	7 Apr 2000
<b>Reprint of the Fish Resources Management Regulations 1995 as at 2 Jun 2000</b> (includes amendments listed above) (correction in <i>Gazette</i> 11 Aug 2000 p. 4693)		
<i>Fish Resources Management Amendment Regulations (No. 2) 2000</i>	25 Aug 2000 p. 4905	25 Aug 2000
<i>Fish Resources Management Amendment Regulations (No. 3) 2000</i>	8 Sep 2000 p. 5185-8	8 Sep 2000
<i>Fish Resources Management Amendment Regulations (No. 5) 2000</i>	26 Sep 2000 p. 5516-17	26 Sep 2000
<i>Fish Resources Management Amendment Regulations (No. 7) 2000</i>	6 Oct 2000 p. 5589-90	6 Oct 2000
<i>Fish Resources Management Amendment Regulations (No. 6) 2000</i>	24 Oct 2000 p. 5965	24 Oct 2000
<i>Fish Resources Management Amendment Regulations (No. 8) 2000</i>	3 Nov 2000 p. 6103	3 Nov 2000

<b>Citation</b>	<b>Gazettal</b>	<b>Commencement</b>
<i>Fish Resources Management Amendment Regulations (No. 9) 2000</i>	29 Dec 2000 p. 7905-7	29 Dec 2000
<i>Fish Resources Management Amendment Regulations (No. 4) 2000</i>	29 Dec 2000 p. 7965-79	29 Dec 2000
<b>Reprint of the <i>Fish Resources Management Regulations 1995</i> as at 2 Mar 2001</b> (includes amendments listed above)		
<i>Fish Resources Management Amendment Regulations (No. 2) 2001</i>	27 Mar 2001 p. 1725	31 Mar 2001 (see r. 2)
<i>Fish Resources Management Amendment Regulations 2001</i>	29 Jun 2001 p. 3161-81	29 Jun 2001
<i>Fish Resources Management Amendment Regulations (No. 5) 2001</i>	13 Jul 2001 p. 3465-6	13 Jul 2001
<i>Fish Resources Management Amendment Regulations (No. 7) 2001</i>	25 Sep 2001 p. 5283	25 Sep 2001
<i>Fish Resources Management Amendment Regulations (No. 10) 2001</i>	12 Oct 2001 p. 5581	12 Oct 2001
<i>Fish Resources Management Amendment Regulations (No. 12) 2001</i>	31 Oct 2001 p. 5789	31 Oct 2001
<i>Fish Resources Management Amendment Regulations (No. 4) 2001</i>	14 Nov 2001 p. 5977-9	14 Nov 2001
<i>Fish Resources Management Amendment Regulations (No. 11) 2001</i>	20 Nov 2001 p. 6010-11	20 Nov 2001
<i>Fish Resources Management Amendment Regulations (No. 13) 2001</i>	18 Dec 2001 p. 6489-92	1 Jan 2002 (see r. 2)
<i>Fish Resources Management Amendment Regulations 2002</i>	22 Jan 2002 p. 359	22 Jan 2002
<i>Fish Resources Management Amendment Regulations (No. 2) 2002</i>	26 Feb 2002 p. 785-7	1 Mar 2002 (see r. 2)
<i>Fish Resources Management Amendment Regulations (No. 5) 2002</i>	3 May 2002 p. 2219	3 May 2002
<b>Reprint of the <i>Fish Resources Management Regulations 1995</i> as at 17 May 2002</b> (includes amendments listed above)		
<i>Fish Resources Management Amendment Regulations (No. 7) 2002</i>	28 Jun 2002 p. 3065-7	1 Jul 2002 (see r. 2)

## **Fish Resources Management Regulations 1995**

<b>Citation</b>	<b>Gazettal</b>	<b>Commencement</b>
<i>Fish Resources Management Amendment Regulations (No. 8) 2002</i>	10 Sep 2002 p. 4593-4	1 Oct 2002 (see r. 2)
<i>Fish Resources Management Amendment Regulations (No. 9) 2002</i>	29 Nov 2002 p. 5652-3	29 Nov 2002
<i>Fish Resources Management Amendment Regulations (No. 10) 2002</i>	29 Nov 2002 p. 5653	29 Nov 2002
<i>Fish Resources Management Amendment Regulations (No. 11) 2002</i>	29 Nov 2002 p. 5654-7	29 Nov 2002
<i>Fish Resources Management Amendment Regulations (No. 13) 2002</i>	29 Nov 2002 p. 5657-8	1 Jan 2003 (see r. 2)
<i>Fish Resources Management Amendment Regulations (No. 14) 2002</i>	13 Dec 2002 p. 5795-8	1 Jan 2003 (see r. 2)
<i>Fish Resources Management Amendment Regulations 2003</i>	11 Feb 2003 p. 411-12	11 Feb 2003
<i>Fish Resources Management Amendment Regulations (No. 3) 2003</i>	21 Feb 2003 p. 633-4	21 Feb 2003
<i>Fish Resources Management Amendment Regulations (No. 2) 2003</i>	28 Feb 2003 p. 660-3	1 Mar 2003 (see r. 2)
<i>Fish Resources Management Amendment Regulations (No. 4) 2003</i>	7 Mar 2003 p. 743-8	7 Mar 2003
<i>Fish Resources Management Amendment Regulations (No. 6) 2003</i>	3 Jun 2003 p. 1979-82	1 Jul 2003 (see r. 2)
<i>Fish Resources Management Amendment Regulations (No. 5) 2003</i>	27 Jun 2003 p. 2389-95	1 Jul 2003 (see r. 2)
<i>Equality of Status Subsidiary Legislation Amendment Regulations 2003 Pt. 13</i>	30 Jun 2003 p. 2581-638	1 Jul 2003 (see r. 2 and <i>Gazette</i> 30 Jun 2003 p. 2579)
<i>Fish Resources Management Amendment Regulations (No. 7) 2003</i>	19 Aug 2003 p. 3714-15	8 Nov 2003 (see r. 2 and <i>Gazette</i> 2 Sep 2003 p. 3923)
<i>Fish Resources Management Amendment Regulations (No. 12) 2003</i>	19 Sep 2003 p. 4118	1 Oct 2003 (see r. 2)
<i>Fish Resources Management Amendment Regulations (No. 11) 2003</i>	19 Sep 2003 p. 4119-25	19 Sep 2003



<b>Citation</b>	<b>Gazettal</b>	<b>Commencement</b>
<i>Fish Resources Management Amendment Regulations (No. 8) 2003</i>	1 Oct 2003 p. 4279-347	1 Oct 2003 (see r. 2)
<i>Fish Resources Management Amendment Regulations (No. 9) 2003</i>	31 Oct 2003 p. 4561-2	8 Nov 2003 (see r. 2)
<i>Fish Resources Management Amendment Regulations (No. 15) 2003</i>	31 Oct 2003 p. 4562-3	8 Nov 2003 (see r. 2)
<b>Reprint 4: The Fish Resources Management Regulations 1995 as at 14 Nov 2003</b> (includes amendments listed above)		
<i>Fish Resources Management Amendment Regulations (No. 16) 2003</i>	28 Nov 2003 p. 4774-6	28 Nov 2003
<i>Fish Resources Management Amendment Regulations (No. 14) 2003</i>	23 Dec 2003 p. 5204-6	23 Dec 2003
<i>Fish Resources Management Amendment Regulations 2004</i>	9 Jan 2004 p. 141-2	9 Jan 2004
<i>Fish Resources Management Amendment Regulations (No. 2) 2004</i>	17 Feb 2004 p. 599-600	1 Mar 2004 (see r. 2)
<i>Fish Resources Management Amendment Regulations (No. 3) 2004</i>	6 Apr 2004 p. 1132-4	6 Apr 2004
<i>Fish Resources Management Amendment Regulations (No. 6) 2004</i>	28 May 2004 p. 1895-902 (as amended 29 Jun 2004 p. 2524)	1 Jul 2004 (see r. 2)
<i>Fish Resources Management Amendment Regulations (No. 5) 2004</i>	29 Jun 2004 p. 2522-3	29 Jun 2004
<i>Fish Resources Management Amendment Regulations (No. 9) 2004</i>	30 Sep 2004 p. 4187-8	30 Sep 2004
<i>Fish Resources Management Amendment Regulations (No. 4) 2004</i>	30 Nov 2004 p. 5486-7	30 Nov 2004
<i>Fish Resources Management Amendment Regulations (No. 10) 2004</i>	30 Dec 2004 p. 6965	1 Jan 2005 (see r. 2 and <i>Gazette</i> 31 Dec 2004 p. 7130)
<i>Fish Resources Management Amendment Regulations 2005</i>	1 Mar 2005 p. 877-8	1 Mar 2005
<i>Fish Resources Management Amendment Regulations (No. 2) 2005</i>	3 Jun 2005 p. 2490-1	3 Jun 2005

## **Fish Resources Management Regulations 1995**

---

<b>Citation</b>	<b>Gazettal</b>	<b>Commencement</b>
<i>Fish Resources Management Amendment Regulations (No. 4) 2005</i>	22 Jul 2005 p. 3372-5	1 Sep 2005 (see r. 2)
<i>Fish Resources Management Amendment Regulations (No. 6) 2005</i>	15 Sep 2005 p. 4309-10	15 Sep 2005 (see r. 2)
<i>Fish Resources Management Amendment Regulations (No. 5) 2005</i>	16 Sep 2005 p. 4313-17	4 Oct 2005 (see r. 2)
<b>Reprint 5: The Fish Resources Management Regulations 1995 as at 14 Oct 2005</b> (includes amendments listed above) (correction in <i>Gazette</i> 9 Jun 2006 p. 2030)		
<i>Fish Resources Management Amendment Regulations (No. 3) 2005</i>	4 Nov 2005 p. 5299-317	4 Nov 2005
<i>Fish Resources Management Amendment Regulations (No. 8) 2005</i>	11 Nov 2005 p. 5565-6	11 Nov 2005
<i>Fish Resources Management Amendment Regulations (No. 7) 2005</i>	22 Dec 2005 p. 6215-39	1 Jan 2006 (see r. 2)
<i>Fish Resources Management Amendment Regulations (No. 3) 2006</i>	7 Feb 2006 p. 619-21	1 Mar 2006 (see r. 2)
<i>Fish Resources Management Amendment Regulations (No. 4) 2006</i>	7 Mar 2006 p. 975	7 Mar 2006
<i>Electricity Corporations (Consequential Amendments) Regulations 2006 r. 80</i>	31 Mar 2006 p. 1299-357	1 Apr 2006 (see r. 2)
<i>Fish Resources Management Amendment Regulations 2006</i>	23 May 2006 p. 1857-61	1 Jul 2006 (see r. 2)
<i>Fish Resources Management Amendment Regulations (No. 5) 2006</i>	5 Sep 2006 p. 3615-17	5 Sep 2006
<b>Reprint 6: The Fish Resources Management Regulations 1995 as at 6 Oct 2006</b> (includes amendments listed above)		
<i>Fish Resources Management Amendment Regulations (No. 6) 2006</i>	10 Nov 2006 p. 4703	10 Nov 2006
<i>Fish Resources Management Amendment Regulations (No. 8) 2006</i>	10 Nov 2006 p. 4704-12	10 Nov 2006
<i>Fish Resources Management Amendment Regulations (No. 7) 2006</i>	29 Dec 2006 p. 5888-92	29 Dec 2006
<i>Fish Resources Management Amendment Regulations (No. 2) 2007</i>	16 Feb 2007 p. 489-90	1 Mar 2007 (see r. 2)
<i>Fish Resources Management Amendment Regulations (No. 5) 2007</i>	12 Jun 2007 p. 2717-19	1 Jul 2007 (see r. 2)

<b>Citation</b>	<b>Gazettal</b>	<b>Commencement</b>
<i>Fish Resources Management Amendment Regulations 2007</i>	6 Jul 2007 p. 3387-90	6 Jul 2007
<i>Fish Resources Management Amendment Regulations (No. 6) 2007</i>	14 Aug 2007 p. 4099-102	r. 1 and 2: 14 Aug 2007 (see r. 2(a)); Regulations other than r. 1 and 2: 15 Aug 2007 (see r. 2(b))
<i>Fish Resources Management Amendment Regulations (No. 7) 2007</i>	4 Sep 2007 p. 4519-21	r. 1 and 2: 4 Sep 2007 (see r. 2(a)); Regulations other than r. 1 and 2: 5 Sep 2007 (see r. 2(b))
<b>Reprint 7: The Fish Resources Management Regulations 1995 as at 19 Oct 2007</b> (includes amendments listed above)		
<i>Fish Resources Management Amendment Regulations (No. 4) 2007</i>	13 Nov 2007 p. 5691-4	r. 1 and 2: 13 Nov 2007 (see r. 2(a)); Regulations other than r. 1 and 2: 1 Jan 2008 (see r. 2(b))
<i>Fish Resources Management Amendment Regulations (No. 8) 2007</i>	21 Dec 2007 p. 6325-6	r. 1 and 2: 21 Dec 2007 (see r. 2(a)); Regulations other than r. 1 and 2: 22 Dec 2007 (see r. 2(b))
<i>Fish Resources Management Amendment Regulations 2008</i>	5 Feb 2008 p. 301-2	r. 1 and 2: 5 Feb 2008 (see r. 2(a)); Regulations other than r. 1 and 2: 1 Mar 2008 (see r. 2(b))
<i>Fish Resources Management Amendment Regulations (No. 3) 2008</i>	27 May 2008 p. 2040-2	r. 1 and 2: 27 May 2008 (see r. 2(a)); Regulations other than r. 1 and 2: 28 May 2008 (see r. 2(b))
<i>Fish Resources Management Amendment Regulations (No. 2) 2008</i>	29 May 2008 p. 2055-9	r. 1 and 2: 29 May 2008 (see r. 2(a)); Regulations other than r. 1 and 2: 30 May 2008 (see r. 2(b))
<i>Fish Resources Management Amendment Regulations (No. 11) 2008</i>	21 Nov 2008 p. 4926-7	r. 1 and 2: 21 Nov 2008 (see r. 2(a)); Regulations other than r. 1 and 2: 1 Dec 2008 (see r. 2(b))
<i>Fish Resources Management Amendment Regulations (No. 8) 2008</i>	19 Dec 2008 p. 5361-3	r. 1 and 2: 19 Dec 2008 (see r. 2(a)); Regulations other than r. 1 and 2: 1 Jan 2009 (see r. 2(b))

## Fish Resources Management Regulations 1995

Citation	Gazettal	Commencement
<i>Fish Resources Management Amendment Regulations (No. 2) 2009</i>	3 Feb 2009 p. 227	r. 1 and 2: 3 Feb 2009 (see r. 2(a)); Regulations other than r. 1 and 2: 4 Feb 2009 (see r. 2(b))
<i>Fish Resources Management Amendment Regulations (No. 3) 2009</i>	11 Feb 2009 p. 287-9	r. 1 and 2: 11 Feb 2009 (see r. 2(a)); Regulations other than r. 1 and 2: 12 Feb 2009 (see r. 2(b))
<i>Fish Resources Management Amendment Regulations 2009</i>	13 Feb 2009 p. 297-300	r. 1 and 2: 13 Feb 2009 (see r. 2(a)); Regulations other than r. 1 and 2: 14 Feb 2009 (see r. 2(b))
<i>Fish Resources Management Amendment Regulations (No. 8) 2009</i>	13 Mar 2009 p. 760-1	r. 1 and 2: 13 Mar 2009 (see r. 2(a)); Regulations other than r. 1 and 2: 14 Mar 2009 (see r. 2(b))
<i>Fish Resources Management Amendment Regulations (No. 5) 2009</i>	27 Mar 2009 p. 922	r. 1 and 2: 27 Mar 2009 (see r. 2(a)); Regulations other than r. 1 and 2: 28 Mar 2009 (see r. 2(b))
<i>Fish Resources Management Amendment Regulations (No. 9) 2009</i>	9 Jun 2009 p. 1911-20	r. 1 and 2: 9 Jun 2009 (see r. 2(a)); Regulations other than r. 1 and 2: 1 Jul 2009 (see r. 2(b))
<i>Fish Resources Management Amendment Regulations (No. 10) 2009</i>	3 Jul 2009 p. 2679-80	r. 1 and 2: 3 Jul 2009 (see r. 2(a)); Regulations other than r. 1 and 2: 4 Jul 2009 (see r. 2(b))
<b>Reprint 8: The Fish Resources Management Regulations 1995 as at 7 Aug 2009</b> (includes amendments listed above) (correction in <i>Gazette</i> 1 Sep 2009 p. 3397)		
<i>Fish Resources Management Amendment Regulations (No. 12) 2009</i>	18 Aug 2009 p. 3237-8	r. 1 and 2: 18 Aug 2009 (see r. 2(a)); Regulations other than r. 1 and 2: 19 Aug 2009 (see r. 2(b))
<i>Fish Resources Management Amendment Regulations (No. 15) 2009</i>	10 Sep 2009 p. 3539	r. 1 and 2: 10 Sep 2009 (see r. 2(a)); Regulations other than r. 1 and 2: 11 Sep 2009 (see r. 2(b))
<i>Fish Resources Management Amendment Regulations (No. 14) 2009</i>	29 Sep 2009 p. 3863-82	r. 1 and 2: 29 Sep 2009 (see r. 2(a)); Regulations other than r. 1 and 2: 15 Oct 2009 (see r. 2(b))

<b>Citation</b>	<b>Gazettal</b>	<b>Commencement</b>
<i>Fish Resources Management Amendment Regulations (No. 13) 2009</i>	13 Oct 2009 p. 4031-4	r. 1 and 2: 13 Oct 2009 (see r. 2(a)); Regulations other than r. 1 and 2: 14 Oct 2009 (see r. 2(b))
<i>Fish Resources Management Amendment Regulations (No. 16) 2009</i>	5 Nov 2009 p. 4411-15	r. 1 and 2: 5 Nov 2009 (see r. 2(a)); Regulations other than r. 1 and 2: 6 Nov 2009 (see r. 2(b))
<i>Fish Resources Management Amendment Regulations (No. 4) 2009</i>	6 Nov 2009 p. 4470-1	r. 1 and 2: 6 Nov 2009 (see r. 2(a)); Regulations other than r. 1 and 2: 7 Nov 2009 (see r. 2(b))
<i>Fish Resources Management Amendment Regulations (No. 18) 2009</i>	8 Dec 2009 p. 4993-8 (printer's correction 15 Dec 2009 p. 5140)	r. 1 and 2: 8 Dec 2009 (see r. 2(a)); Regulations other than r. 1 and 2: 16 Dec 2009 (see r. 2(b))
<i>Fish Resources Management Amendment Regulations 2010</i>	12 Feb 2010 p. 584-7	r. 1 and 2: 12 Feb 2010 (see r. 2(a)); Regulations other than r. 1 and 2: 2 Mar 2010 (see r. 2(b))
<i>Fish Resources Management Amendment Regulations (No. 2) 2010</i>	12 Feb 2010 p. 587-8	r. 1 and 2: 12 Feb 2010 (see r. 2(a)); Regulations other than r. 1 and 2: 13 Feb 2010 (see r. 2(b))
<b>Reprint 9: The Fish Resources Management Regulations 1995 as at 9 Apr 2010</b> (includes amendments listed above)		
<i>Fish Resources Management Amendment Regulations (No. 4) 2010</i>	28 May 2010 p. 2383-5	r. 1 and 2: 28 May 2010 (see r. 2(a)); Regulations other than r. 1 and 2: 29 May 2010 (see r. 2(b))
<i>Fish Resources Management Amendment Regulations (No. 3) 2010</i>	23 Jul 2010 p. 3402-6	r. 1 and 2: 23 Jul 2010 (see r. 2(a)); Regulations other than r. 1 and 2: 24 Jul 2010 (see r. 2(b))
<i>Fish Resources Management Amendment Regulations (No. 6) 2010</i>	27 Aug 2010 p. 4106-11	r. 1 and 2: 27 Aug 2010 (see r. 2(a)); Regulations other than r. 1 and 2: 28 Aug 2010 (see r. 2(b))

**Fish Resources Management Regulations 1995**

<b>Citation</b>	<b>Gazettal</b>	<b>Commencement</b>
<i>Fish Resources Management Amendment Regulations (No. 7) 2010</i>	10 Sep 2010 p. 4347	r. 1 and 2: 10 Sep 2010 (see r. 2(a)); Regulations other than r. 1 and 2: 11 Sep 2010 (see r. 2(b))
<i>Fish Resources Management Amendment Regulations (No. 8) 2010</i>	8 Oct 2010 p. 5134-5	r. 1 and 2: 8 Oct 2010 (see r. 2(a)); Regulations other than r. 1 and 2: 9 Oct 2010 (see r. 2(b))
<i>Fish Resources Management Amendment Regulations (No. 9) 2010</i>	2 Dec 2010 p. 6031-4	r. 1 and 2: 2 Dec 2010 (see r. 2(a)); Regulations other than r. 1 and 2: 3 Dec 2010 (see r. 2(b))
<i>Fish Resources Management Amendment Regulations 2011</i>	1 Mar 2011 p. 667	r. 1 and 2: 1 Mar 2011 (see r. 2(a)); Regulations other than r. 1 and 2: 2 Mar 2011 (see r. 2(b))
<i>Fish Resources Management Amendment Regulations (No. 2) 2011</i>	1 Mar 2011 p. 668-73	r. 1 and 2: 1 Mar 2011 (see r. 2(a)); Regulations other than r. 1 and 2: 2 Mar 2011 (see r. 2(b))
<i>Fish Resources Management Amendment Regulations (No. 3) 2011</i>	1 Mar 2011 p. 673-5	r. 1 and 2: 1 Mar 2011 (see r. 2(a)); Regulations other than r. 1 and 2: 2 Mar 2011 (see r. 2(b))
<i>Fish Resources Management Amendment Regulations (No. 4) 2011</i>	29 Mar 2011 p. 1151-3	r. 1 and 2: 29 Mar 2011 (see r. 2(a)); Regulations other than r. 1 and 2: 30 Mar 2011 (see r. 2(b))
<i>Fish Resources Management Amendment Regulations (No. 5) 2011</i>	6 May 2011 p. 1609-12	r. 1 and 2: 6 May 2011 (see r. 2(a)); Regulations other than r. 1 and 2: 1 Jul 2011 (see r. 2(b))
<i>Fish Resources Management Amendment Regulations (No. 7) 2011</i> Pt. 2	1 Jul 2011 p. 2721-3	1 Jul 2011 (see r. 2(b))
<b>Reprint 10: The Fish Resources Management Regulations 1995 as at 4 Jul 2011</b> (includes amendments listed above)		
<i>Fish Resources Management Amendment Regulations (No. 6) 2011</i>	2 Aug 2011 p. 3166-8	r. 1 and 2: 2 Aug 2011 (see r. 2(a)); Regulations other than r. 1 and 2: 3 Aug 2011 (see r. 2(b))

<b>Citation</b>	<b>Gazettal</b>	<b>Commencement</b>
<i>Fish Resources Management Amendment Regulations (No. 8) 2011</i>	2 Aug 2011 p. 3168-9	r. 1 and 2: 2 Aug 2011 (see r. 2(a)); Regulations other than r. 1 and 2: 3 Aug 2011 (see r. 2(b))
<i>Fish Resources Management Amendment Regulations (No. 10) 2011</i>	24 Aug 2011 p. 3405-9	r. 1 and 2: 24 Aug 2011 (see r. 2(a)); Regulations other than r. 1 and 2: 25 Aug 2011 (see r. 2(b))
<i>Fish Resources Management Amendment Regulations (No. 11) 2011</i>	9 Sep 2011 p. 3682-3	r. 1 and 2: 9 Sep 2011 (see r. 2(a)); Regulations other than r. 1 and 2: 10 Sep 2011 (see r. 2(b))
<i>Fish Resources Management Amendment Regulations (No. 9) 2011</i>	2 Nov 2011 p. 4619-25	r. 1 and 2: 2 Nov 2011 (see r. 2(a)); Regulations other than r. 1, 2 and 9: 3 Nov 2011 (see r. 2(c)); r. 9: 15 Nov 2011 (see r. 2(b))
<i>Fish Resources Management Amendment Regulations (No. 12) 2011</i>	18 Nov 2011 p. 4809-10	r. 1 and 2: 18 Nov 2011 (see r. 2(a)); Regulations other than r. 1 and 2: 19 Nov 2011 (see r. 2(b))
<i>Fish Resources Management Amendment Regulations (No. 13) 2011</i>	22 Nov 2011 p. 4847-8	r. 1 and 2: 22 Nov 2011 (see r. 2(a)); Regulations other than r. 1 and 2: 23 Nov 2011 (see r. 2(b))
<i>Fish Resources Management Amendment Regulations (No. 14) 2011</i>	20 Dec 2011 p. 5374-5	r. 1 and 2: 20 Dec 2011 (see r. 2(a)); Regulations other than r. 1, 2, 4 and 6: 21 Dec 2011 (see r. 2(c)); r. 4 and 6: 8 Jan 2012 (see r. 2(b))
<i>Fish Resources Management Amendment Regulations 2012</i>	24 Feb 2012 p. 801-3	r. 1 and 2: 24 Feb 2012 (see r. 2(a)); Regulations other than r. 1 and 2: 25 Feb 2012 (see r. 2(b))
<b>Reprint 11: The Fish Resources Management Regulations 1995 as at 13 Apr 2012</b> (includes amendments listed above)		
<i>Fish Resources Management Amendment Regulations (No. 3) 2012</i>	22 Jun 2012 p. 2778-9	r. 1 and 2: 22 Jun 2012 (see r. 2(a)); Regulations other than r. 1 and 2: 23 Jun 2012 (see r. 2(b))

## Fish Resources Management Regulations 1995

Citation	Gazettal	Commencement
<i>Fish Resources Management Amendment Regulations (No. 4) 2012</i>	14 Sep 2012 p. 4372-5	r. 1 and 2: 14 Sep 2012 (see r. 2(a)); Regulations other than r. 1 and 2: 15 Sep 2012 (see r. 2(b))
<i>Fish Resources Management Amendment Regulations (No. 5) 2012</i>	25 Sep 2012 p. 4517-21	r. 1 and 2: 25 Sep 2012 (see r. 2(a)); Regulations other than r. 1 and 2: 26 Sep 2012 (see r. 2(b))
<i>Fish Resources Management Amendment Regulations (No. 10) 2012</i>	17 Oct 2012 p. 4979-80	r. 1 and 2: 17 Oct 2012 (see r. 2(a)); Regulations other than r. 1 and 2: 18 Oct 2012 (see r. 2(b))
<i>Fish Resources Management Amendment Regulations (No. 8) 2012</i>	19 Oct 2012 p. 5017-20	r. 1 and 2: 19 Oct 2012 (see r. 2(a)); Regulations other than r. 1 and 2: 20 Oct 2012 (see r. 2(b))
<i>Fish Resources Management Amendment Regulations (No. 11) 2012</i>	2 Nov 2012 p. 5277-8	r. 1 and 2: 2 Nov 2012 (see r. 2(a)); Regulations other than r. 1 and 2: 3 Nov 2012 (see r. 2(b))
<i>Fish Resources Management Amendment Regulations (No. 6) 2012</i>	4 Dec 2012 p. 5919-20	r. 1 and 2: 4 Dec 2012 (see r. 2(a)); Regulations other than r. 1 and 2: 5 Dec 2012 (see r. 2(b))
<i>Fish Resources Management Amendment Regulations (No. 7) 2012</i>	18 Dec 2012 p. 6591-2	r. 1 and 2: 18 Dec 2012 (see r. 2(a)); Regulations other than r. 1 and 2: 19 Dec 2012 (see r. 2(b))
<i>Fish Resources Management Amendment Regulations (No. 13) 2012</i>	18 Dec 2012 p. 6592-3	r. 1 and 2: 18 Dec 2012 (see r. 2(a)); Regulations other than r. 1 and 2: 1 Jan 2013 (see r. 2(b))
<i>Fish Resources Management Amendment Regulations (No. 2) 2013</i>	29 Jan 2013 p. 301-19	r. 1 and 2: 29 Jan 2013 (see r. 2(a)); Regulations other than r. 1 and 2: 1 Feb 2013 (see r. 2(b))
<i>Fish Resources Management Amendment Regulations (No. 14) 2012</i>	1 Mar 2013 p. 1091-2	r. 1 and 2: 1 Mar 2013 (see r. 2(a)); Regulations other than r. 1 & 2: 1 Mar 2013 <sup>7</sup>



<b>Citation</b>	<b>Gazettal</b>	<b>Commencement</b>
<i>Fish Resources Management Amendment Regulations (No. 3) 2013</i>	18 Jun 2013 p. 2295-9	r. 1 and 2: 18 Jun 2013 (see r. 2(a)); Regulations other than r. 1 and 2: 19 Jun 2013 (see r. 2(b))
<i>Fish Resources Management Amendment Regulations (No. 4) 2013</i>	28 Jun 2013 p. 2887-904	r. 1 and 2: 28 Jun 2013 (see r. 2(a)); r. 13: 29 Jun 2013 (see r. 2(b)(i) and <i>Gazette</i> 18 Jun 2013 p. 2295); Regulations other than r. 1, 2 and 13: 29 Jun 2013 (see r. 2(c))
<b>Reprint 12: The Fish Resources Management Regulations 1995 as at 19 Jul 2013</b> (includes amendments listed above)		
<i>Fish Resources Management Amendment Regulations (No. 6) 2013</i>	27 Aug 2013 p. 4053-7	r. 1 and 2: 27 Aug 2013 (see r. 2(a)); Regulations other than r. 1 and 2: 28 Aug 2013 (see r. 2(b))
<i>Fish Resources Management Amendment Regulations (No. 7) 2013</i>	4 Sep 2013 p. 4179-83	r. 1 and 2: 4 Sep 2013 (see r. 2(a)); Regulations other than r. 1 and 2: 5 Sep 2013 (see r. 2(b))
<i>Fish Resources Management Amendment Regulations (No. 5) 2013</i>	24 Sep 2013 p. 4437-56	r. 1 and 2: 24 Sep 2013 (see r. 2(a)); Regulations other than r. 1 and 2: 25 Sep 2013 (see r. 2(b))
<i>Fish Resources Management Amendment Regulations (No. 11) 2013</i>	15 Nov 2013 p. 5238	r. 1 and 2: 15 Nov 2013 (see r. 2(a)); Regulations other than r. 1 and 2: 16 Nov 2013 (see r. 2(b))
<i>Fish Resources Management Amendment Regulations (No. 8) 2013</i>	19 Nov 2013 p. 5283-91	r. 1 and 2: 19 Nov 2013 (see r. 2(a)); Regulations other than r. 1 and 2: 20 Nov 2013 (see r. 2(b))
<i>Fish Resources Management Amendment Regulations 2014</i>	30 May 2014 p. 1713-37	Pt. 1: 30 May 2014 (see r. 2(a)); Pt. 2 and 3: 31 May 2014 (see r. 2(b)); Pt. 4: 1 Jul 2014 (see r. 2(c))
<i>Fish Resources Management Amendment Regulations (No. 5) 2014</i>	12 Aug 2014 p. 2903-7	r. 1 and 2: 12 Aug 2014 (see r. 2(a)); Regulations other than r. 1 and 2: 13 Aug 2014 (see r. 2(b))

<b>Citation</b>	<b>Gazettal</b>	<b>Commencement</b>
<i>Fish Resources Management Amendment Regulations (No. 4) 2014</i>	26 Aug 2014 p. 3082-4	r. 1 and 2: 26 Aug 2014 (see r. 2(a)); Regulations other than r. 1 and 2: 27 Aug 2014 (see r. 2(b))
<i>Fish Resources Management Amendment Regulations (No. 3) 2014</i>	9 Sep 2014 p. 3239-40	r. 1 and 2: 9 Sep 2014 (see r. 2(a)); Regulations other than r. 1 and 2: 10 Sep 2014 (see r. 2(b))
<i>Fish Resources Management Amendment Regulations (No. 6) 2014</i>	22 Oct 2014 p. 4087-115	r. 1 and 2: 22 Oct 2014 (see r. 2(a)); Regulations other than r. 1 and 2: 23 Oct 2014 (see r. 2(b))
<i>Fish Resources Management Amendment Regulations (No. 7) 2014</i>	31 Oct 2014 p. 4199-200	r. 1 and 2: 31 Oct 2014 (see r. 2(a)); Regulations other than r. 1 and 2: 1 Nov 2014 (see r. 2(b))

<sup>2</sup> Footnote no longer applicable.

<sup>3</sup> Under the *Public Sector Management Act 1994* the names of departments may be changed. At the time of this reprint the former Department of Conservation and Land Management is called the Department of Parks and Wildlife.

<sup>4</sup> The name of the Fisheries Research and Development Fund was changed by the *Financial Legislation Amendment and Repeal Act 2006* (now the *Financial Management (Transitional Provisions) Act 2006*) s. 17 to the Fisheries Research and Development Account.

<sup>5</sup> The name of the Recreational Fishing Fund was changed by the *Financial Legislation Amendment and Repeal Act 2006* (now the *Financial Management (Transitional Provisions) Act 2006*) s. 17 to the Recreational Fishing Account.

<sup>6</sup> Disallowed on 16 Jun 1999, see *Gazette* 25 Jun 1999 p. 2742.

<sup>7</sup> The commencement date of 15 Jan 2013 that was specified in r. 2(b) was before the date of gazettal.

## Defined terms

*[This is a list of terms defined and the provisions where they are defined.  
The list is not part of the law.]*

<b>Defined term</b>	<b>Provision(s)</b>
Abalone Zone.....	3(1)
Abrolhos Islands Fish Habitat Protection Area.....	3(1)
aircraft.....	3(1)
ALC.....	55A
ALC fishing boat.....	55C(1)
allowed time.....	31(1)
applicant.....	123A(1), 124A(1), 124D(1)
approval to transport.....	144A(1)
approved.....	72, 144A(1)
approved automatic location communicator.....	55A
approved directions.....	55A
associated camp.....	72
attend.....	64B, 64M
authorisation.....	129A
automatic location communicator.....	55A
bag limit.....	3(1)
bait band.....	55E
bait fish.....	64OE(4)
batch.....	144A(1)
boat.....	124B(1), 128IA
bona fide.....	64I(2)
camp.....	72
cancelled authorisation.....	129A
carrier boat.....	119(1)
carrier boat licence.....	3(1)
Central West Zone.....	38(1)
certificate of health.....	144A(1)
charter boat.....	16E(1)
chlorine tarping.....	110(2)
closed season.....	38G, 45(1)
commercial fishing licence.....	3(1)
commercial fishing licence receipt.....	123A(1)
commercial premises.....	64AA(1)
complying drop net.....	3(1)
Cottesloe Reef waters.....	3(1)
courier business.....	147A(1)
current entitlement.....	118A(2)
Dampier Archipelago waters.....	64OB(3)
day.....	124B(1)

**Defined terms**

---

day trip .....	16E(1), 22(5)
dB(A) .....	104(4)
deep sea crab .....	38A
demersal finfish.....	65A(1), 65B(1)
demersal scalefish .....	45(1), 64OAA(1)
destroy.....	144A(1)
disease.....	3(1), 144A(1)
diseased.....	144A(2)
disinfect.....	144A(1)
disposable part .....	16B(5)
due date .....	137(4)
Easter Group Zone .....	38(1)
eastern gulf land area .....	3(1)
farm lease.....	144A(1)
fillet.....	3(1)
finfish.....	3(1), 16C, 65F(1A)
fish processor's licence .....	3(1)
fish trunk.....	3(1)
fishing boat licence .....	3(1)
fishing net .....	3(1)
fishing season.....	38D(1)
fishing year .....	16G
form.....	3(1)
former authorisation holder.....	129A
freshwater finfish .....	65E
freshwater fish.....	44A(1)
Freycinet Estuary .....	3(1)
Freycinet Estuary area.....	16G
full amount outstanding of the fee .....	137(5)
Gascoyne Region .....	3(1)
GDA.....	152(1)
gear identification number .....	3(1)
ground .....	64I(2)
GRS80.....	152(2)
hatchery.....	144A(1)
hatchery licence .....	144A(1)
hatchery permit .....	144A(1)
inspector.....	144A(1)
interdorsal fin length .....	Sch. 2
internal SLED .....	38(1)
jet ski.....	3(1)
jetty .....	72
Kalbarri Blue Holes waters .....	3(1)
Lancelin Island Lagoon.....	3(1)
large pelagic finfish.....	65C(1)

Defined terms

length .....	144A(1)
licence holder .....	55A
licensed boat.....	72
licensed carrier boat .....	3(1)
licensed carrier boat number .....	3(1)
licensed fishing boat .....	3(1)
licensed fishing boat number .....	3(1)
live import list .....	69A(1)
mammal or bird products .....	63A(1)
marron drop net.....	3(1), 38G
marron pole snare.....	3(1), 38G
marron scoop net.....	3(1), 38G
marron trophy waters .....	3(1)
May — October .....	64OD(4)
metropolitan waters.....	3(1)
mollusc.....	3(1)
Montebello Islands Marine Park .....	Sch. 5
mooring .....	72
motor boat.....	3(1)
nearshore or estuarine finfish .....	65D(1)
Ningaloo Marine Park.....	3(1)
non-possession period .....	38O(3)
notice.....	55B(1A)
notional bag limit .....	162(2)
November — April .....	64OD(4)
one day.....	3(1)
operator .....	72
ornamental fish.....	69A(1)
package .....	22(5), 61(3a)
pearl oyster farm .....	144A(1)
Pelsaert Group Zone .....	38(1)
person engaged for a commercial purpose in an activity .....	64(1A)
Pilbara and Kimberley Region.....	3(1)
Point Quobba restricted area .....	113D
Port of Albany .....	Sch. 5
Port of Bunbury .....	Sch. 5
Port of Fremantle .....	Sch. 5
prawn hand trawl net.....	3(1)
prescribed abalone .....	16GD(1)
principal place of residence.....	3(1)
pull .....	3(1)
quarantine site .....	144A(1)
recreational (boat) fishing licence receipt .....	124D(1)
recreational fishing licence .....	3(1), 136(1)
recreational fishing licence receipt.....	124A(1)

**Defined terms**

---

region .....	3(1)
release weight.....	64OAA(1)
reserve.....	72
restricted fishing tour .....	128S(1)
return .....	64(1A)
rock lobster licence .....	72
rock lobster pot .....	3(1)
rock lobster pot licence .....	3(1)
rock lobster tail .....	3(1)
Rottnest Island Reserve.....	Sch. 2 cl. 4(2)
Rowley Shoals Marine Park.....	Sch. 2
scheduled fish disease .....	3(1)
sea lion exclusion device.....	38(3)
Sea Lion Protection Zone.....	38(1)
section 224 .....	129A
set .....	3(1)
setose.....	Sch. 2
settlement .....	144A(1)
share arrangement .....	72
single-sided fillet.....	3(1), 16E(1)
South Coast Region.....	3(1)
spat .....	144A(1)
spat collector .....	144A(1)
specified size .....	14A
store.....	22(5)
structure .....	87
sunrise .....	3(1)
sunset .....	3(1)
tail clip .....	31(1)
tail punch.....	31(1)
tarspot.....	Sch. 2
unauthorised structure .....	87
unlicensed person.....	124B(3)
usual entitlement .....	118A(2)
waters of Point Quobba.....	113D
waters of the Shark Bay eastern gulf.....	3(1)
waters of the Shark Bay western gulf .....	3(1)
WCRL Managed Fishery .....	55E
West Coast Demersal Scalefish (Interim) Managed Fishery .....	64OAA(1)
West Coast Region.....	3(1)
Western Australian pearl oyster fishery .....	144A(1)
western gulf land area .....	3(1)
whole fish.....	3(1)

**Defined terms**

---

whole shark or ray..... 16B(5)  
zone..... 144A(1)